

**BN-800E**

**Super Mini Flex ATX Main Board**

*User's Manual*



# TABLE OF CONTENTS

---

<b>1 INTRODUCTION .....</b>	<b>6</b>
<b>1.1 TO DIFFERENT USERS .....</b>	<b>6</b>
First-Time DIY System Builder .....	6
Experienced DIY User .....	6
System Integrator .....	6
<b>1.2 ITEM CHECKLIST .....</b>	<b>7</b>
<b>2 FEATURES .....</b>	<b>8</b>
<b>2.1 SPECIFICATIONS .....</b>	<b>8</b>
<b>3 HARDWARE INSTALLATION .....</b>	<b>11</b>
<b>3.1 STEP-BY-STEP INSTALLATION .....</b>	<b>11</b>
STEP 1 Install the CPU .....	12
STEP 2 Set Jumpers .....	13
STEP 3 Install SDRAM System Memory .....	13
STEP 4 Install Internal Peripherals in System Case .....	14
STEP 5 Mount the Mainboard on the Computer Chassis .....	15
STEP 6 Connect Front-panel Switches/LEDs/Speaker/Audio/USB .....	16
STEP 7 Connect IDE & Floppy Disk Drives .....	18
STEP 8 Connect Other Internal Peripherals .....	19
STEP 9 Connect Power Supply .....	19
STEP 10 Install Add-on Cards in Expansion Slots .....	20
STEP 11 Connect External Peripherals to Back-panel .....	21
STEP 12 First Time System Boot Up .....	23
STEP 13 Install Driver & Software Components .....	24

---

<b>3.2 JUMPER SETTINGS .....</b>	<b>25</b>
<b>JUMPER &amp; CONNECTOR GUIDE .....</b>	<b>26</b>

***Jumpers***

Clear CMOS (J10) .....	28
------------------------	----

***Back-Panel Connectors***

PS/2 Keyboard & PS/2 Mouse Connectors .....	29
USB0/USB1 Port Connectors .....	29
COM1 Connector .....	29
VGA Connector .....	29
Parallel Port Connector .....	29
Line-Out .....	30
Mic-In .....	30

***Front-Panel Connectors***

ATX Power On/Off Switch Connector (PWON) .....	31
EPMI Connector (EPMI) .....	31
Green LED Connector (G LED) .....	31
HDD LED Connector (HD LED) .....	32
PWR LED Connector (PW LED) .....	32
Hardware Reset Connector (RST) .....	32
Speaker Connector (SPK) .....	32
Line-Out and Mic-In Header .....	33
Front-panel USB Connector Header (USB2) .....	33

---

<b><i>Internal Peripherals Connectors</i></b>	
Enhanced IDE Ports and Floppy Connectors .....	34
<b><i>Other Connectors</i></b>	
ATX Power Supply Connector (JWR1) .....	35
Cooling FAN Connectors for CPU FANs (FAN1), & AGP FAN Chassis (FAN2) .....	35
COM2 Connector (JP6) .....	36
Audio Connector AUX_out (JP3) .....	37
Audio Connector MIC_In (JP5) .....	37
Audio Connector CD_In (JP7) .....	37
<b>3.3 SYSTEM MEMORY CONFIGURATION .....</b>	<b>38</b>
Install Memory .....	38
Upgrade Memory .....	38
<b>4 SOFTWARE UTILITY .....</b>	<b>39</b>
4.1 Mainboard CD Overview .....	39
4.2 Install VIA 4 in 1 Driver .....	40
4.3 Install AGP Device Software .....	41
4.4 Install Audio Device Software .....	42
4.5 Install Hardware Monitor Device Software .....	43
4.6 View the User's Manual .....	44

---

**5 BIOS SETUP .....45**

- 5.1 ENTER THE BIOS .....45
- 5.2 THE MAIN MENU .....46
  - STANDARD CMOS FEATURES .....48
  - ADVANCED BIOS FEATURES .....52
  - ADVANCED CHIPSET FEATURES .....56
  - INTEGRATED PERIPHERALS .....60
  - POWER MANAGEMENT SETUP .....64
  - PNP/PCI CONFIGURATION .....69
  - PC HEALTH STATUS .....71
  - FREQUENCY/VOLTAGE CONTROL .....72
  - LOAD FAIL-SAFE DEFAULTS .....73
  - LOAD OPTIMIZED DEFAULTS .....73
  - SET SUPERVISOR PASSWORD .....74
  - SET USER PASSWORD .....74
  - SAVE & EXIT SETUP .....76
  - EXIT WITHOUT SAVING .....76

# 1 INTRODUCTION

---

## 1.1 To Different Users

### First-Time DIY System Builder

Welcome to the DIY world! Building your own computer system is not as difficult as you may think. To make your first computer DIY experience successful, right from the start, we have designed the **Chapter 3 Hardware Installation** section in a step-by-step fashion for all the first-time DIY system builders. Prior to installation, we also suggest you to read the whole manual carefully to gain a complete understanding of your new mainboard.

### Experienced DIY User

Congratulate on your purchase of BN-800E mainboard. You will find that installing your new BN-800E mainboard is just easy. Bundled with an array of onboard functions, the highly-integrated mainboard provides you with a total solution to build the most stable and reliable system. Refer to sections **3.2 Jumper Settings** and **Chapter 4 Software Utility** to find out how to get the best out of your new mainboard. **Chapter 5 BIOS Setup** also contains the relevant information on how to tune up your system to achieve higher performance.

### System Integrator

You have wisely chose BN-800E to construct your system. The mainboard incorporates all the state-of-the-art technology of the VT8604 chipset from VIA. It integrates the most advanced functions you can find to date in a compact MicroATX board. Refer to sections **3.2 Jumper Settings** and **Chapter 4 Software Utility** for an in-depth view of system construction.

---

## 1.2 Item Checklist

Check all items with you mainboard to make sure nothing is missing.  
The complete package should include:

\* **One BN-800E Mainboard**

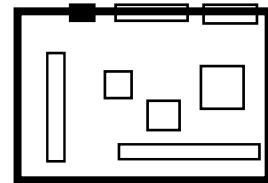

\* One ATA33/66 Ribbon Cable



\* One Floppy Ribbon Cable



\* One Bundled CD-ROM containing:

- user's manual on PDF format
- VIA 4-IN-1 driver
- S3 VGA driver
- Audio AC'97 2.1 CODEC driver
- VIA Hardware Monitor driver
- Award Flashing Utility

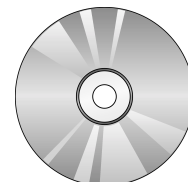

# 2 FEATURES

---

mainboard is carefully designed for the demanding PC user who wants high performance and maximum intelligent features in a compact package.

## 2.1 Specifications

### \* CPU Support

Support Socket370 package CPU with 66/100/133 MHz FSB.

Intel PPGA/FC-PGA Celeron processors: 300 ~ 733+ MHz.

Intel Pentium III FC-PGA processors: 500MHz ~ 1.1 GHz.

### \* Chipset

Features VIA VT8604 AGPset and VT82C686A/VT82C686B Chipset.

### \* Jumperless CPU Configuration

Soft-configuration FSB (The FSB speed is software configurable in the Chipset Features Setup menu of the BIOS Setup utility.)

### \* Integrated Graphics Controller

3D Hyper Pipelined Architecture

Full 2D Acceleration

Motion Video Acceleration

Digital Video output

4 to 32MB frame buffer using system memory

### \* AC'97 Link for Audio and Telephony CODEC

AC'97 2.1 compliant

Separate independent PCI functions for Audio and Modem

### \* Versatile Memory Support

Is equipped with two DIMM slots of PC100 or PC133 compliant SDRAM to provide up to 1GB of system memory.

Configurable support for EC (Error Checking) and ECC (Error Checking and Correcting)

### \* PCI Expansion Slots

Provides one 32-bit PCI slots.



### **\* I/O Interface**

Provides a variety of I/O interfaces:

- 1 × Floppy interface for 3.5-inch FDD with 720KB, 1.44MB, or 2.88MB format or for 5.25-inch FDD with 360K or 1.2MB format.
- 1 × PS/2 mouse connector.
- 1 × PS/2 Keyboard connector.
- 2 × DB9 Serial connectors 16550 UART compatible.
- 1 × DB15 VGA connector.
- 1 × Infrared communication port ASKIR and HPSIR compatible.  
(Serial port COM2 can also be redirected to an external IrDA Adapter for wireless connection.)
- 1 × DB25 Parallel port supporting Standard Parallel Port (SPP), Enhanced Parallel Port (EPP), and Extended Capabilities Port (ECP) data transmission schemes.

### **\* USB Interface Onboard**

- 2 × USB connectors on back-panel and 10 pin header for USB connectors on front-panel.

### **\* PCI Bus Master IDE Controller Onboard**

Two UltraDMA 33/66 (UltraDMA100 for 686B S.B) Bus Master Dual-channel IDE ports provide support to a maximum of four IDE devices (one Master and one Slave per channel). The IDE Bus implements the data transfer speed up to 33/66 MB/sec and also supports Enhanced PIO Modes 0 ~ 4 80-pin Cable Backward Compatible Legacy ATAPI Devices, ATAPI IDE CD-ROM, CD-R, CD-RW, and LS-120 Supports.

### **\* ATX Power Supply Connector**

ATX power supply unit can be connect to the onboard 20-pin ATX power connector, supporting Suspend and Soft-On/Off by dual-function power button.

---

## \* **Advanced Configuration and Power Interface**

Features four power saving modes: Snoop, Suspend to RAM, Suspend to Disk, and Soft-Off. ACPI provides more efficient Energy Savings Features controlled by your operating system that supports OS Direct Power Management (OSPM) functionality.

## \* **System BIOS**

Provides licensed Award BIOS V6.0 PG on Intel Firmware Hub with 2 Mb flash core and supports Green PC, Desktop Management Interface (DMI).

## \* **Mini Flex ATX Form Factor**

System board conforms to the Mini Flex ATX specification.

Board dimension: 165mm x165mm.

## \* **Advanced Features**

- **Dual Function Power Button** - The system can be in one of two states; one is Suspend mode and the other is Soft-Off mode. Pushing the power button for less than 4 seconds places the system into Suspend mode. When the power button is pressed for longer than 4 seconds, the system enters the Soft-Off mode.

## \* **Intelligent Features**

- **Voltage Monitoring** - Monitors various voltages of key elements, such as the CPU, and other critical system voltage levels to ensure stable current passing through mainboard components. System voltages include Vcore on CPU, and +5V, +12V, -5V, -12V on system etc.
- **Fan Status Monitoring** - To prevent CPU from overheating, the CPU fan is monitored for RPM and failure. (CPU Cooling FAN with RPM sensor is required.)
- **Temperature Monitoring** - This item allows users to make sure whether the CPU or system runs in a suitable temperature.



—

---

## Step 2.

### Set Jumpers

This mainboard is jumperless! The default jumper settings have been set for the common usage standard of this mainboard. Therefore, you do not need to reset the jumpers unless you require special adjustments as in any of the following cases:

1. Over-clock your CPU
2. Disable the onboard audio before installing an add-on sound card
3. Clear CMOS

For first-time DIY system builders, we recommend that you do not change the default jumper settings if you are not totally familiar with mainboard configuration procedures. The factory-set default settings are tuned for optimum system performance. For the advanced users who wish to customize their system, section **3.2 Jumper Settings** will provide detailed information on how to configure your mainboard manually.

## Step 3.

### Install SDRAM System Memory

To install memory, insert SDRAM memory module(s) in any one or two DIMM slot(s). Note that SDRAM modules are directional and will not go in the DIMM slots unless properly oriented. After the module is fully inserted into the DIMM slot, lift the clips of both sides of the DIMM slot to lock the module in place.

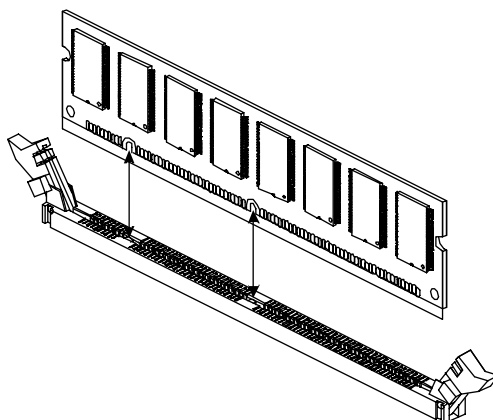

---

## **Step 4**

### **Install Internal Peripherals in System Case**

Before you install and connect the mainboard into your system case, we recommend that you first assemble all the internal peripheral devices into the computer housing, including but not limited to the hard disk drive (IDE /HDD), floppy disk drive (FDD), CD-ROM drive, and ATX power supply unit. This will greatly facilitate in making the connections to the mainboard described below.

To install IDE & FDD drives, follow this procedure:

1. Set the required jumpers on board each device according to the instructions provided by the manufacturer. (IDE devices, HDD, and CD-ROM have to set jumpers on Master or Slave mode depending on your willing to install more than one device for each kind.)
2. Connect IDE cable and FDD cable to the back-panel of the internal peripheral devices. Note that the cable should be oriented with its colored stripe (usually in red or magenta) connected to pin#1 both on the mainboard IDE or FDD connector and on the device as well.
3. Connect an available power cable through your system power supply unit to the back-panel of each peripheral device. Note that the power cable is directional and cannot fit in if not properly positioned.

---

## Step 5

### Mount the Mainboard on the Computer Chassis

1. You may find that there are a lot of different mounting hole positions both on your computer chassis and on the mainboard. To choose a correct mounting hole, the key point is to keep the back-panel of the mainboard in a close fit with your system case, as shown below.

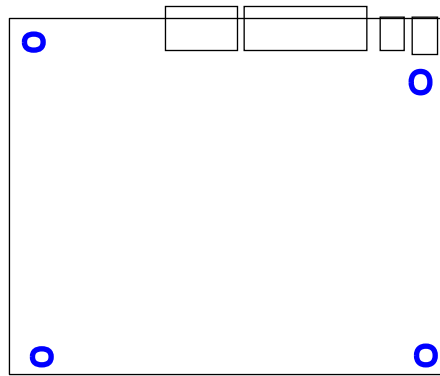

2. After deciding on the proper mounting holes, position the studs between the frame of chassis and the mainboard. The studs are used to fix the mainboard and to keep a certain distance between the system chassis and the mainboard, in order to avoid any electrical short between the board and the metal frame of chassis. (If your computer case is already equipped with mounting studs, you will need to tighten screws to attach the mainboard.)

**Note:** In most computer housings, you will be able to find 4 or more attachment points to install mounting studs and fix the mainboard. If there aren't enough matching holes, then make sure to install at least 3 mounting studs to ensure proper attachment of the mainboard.

## Step 6

### Connect Front-panel Switches/LEDs/Speaker/Audio/USB connectors

You can find there are several different cables already existing in the system case and originating from the computer's front-panel devices (HDD LED, Power LED, Reset Switch, PC Speaker, or USB devices etc.) These cables serve to connect the front-panel switches, LEDs, USB, Line-Out, and Mic-In connectors to the mainboard's front-panel connectors (JP9,SJP5, and USB2), as shown below.

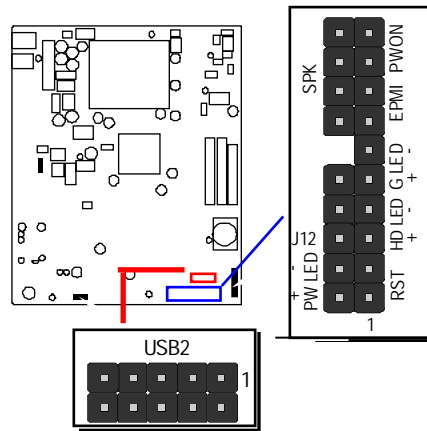

#### 1. ATX Soft Power On/Off (PWON)

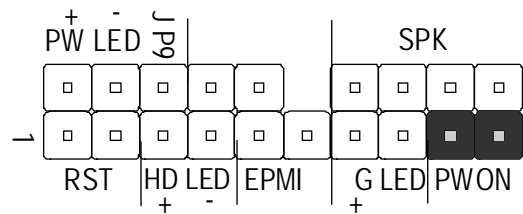

#### 2. Green\_LED

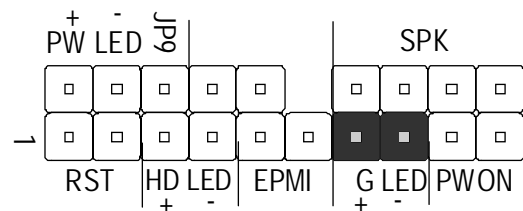

3. EMPI (System Management)

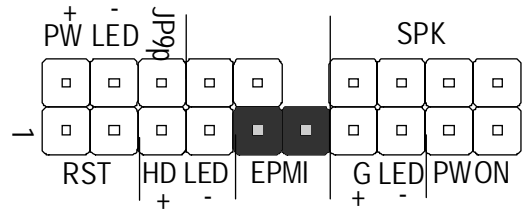

4. HDD\_LED (HD LED)

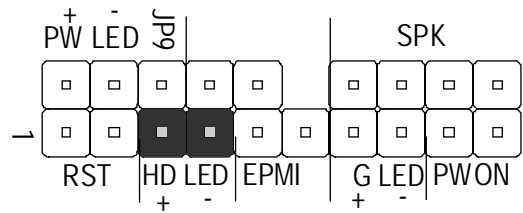

5. Power-LED (PW LED)

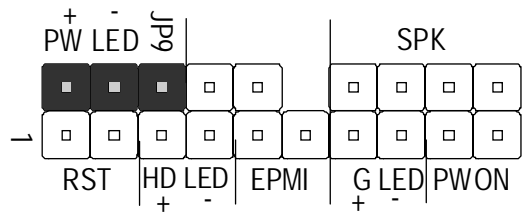

6. Hardware Reset Switch (RST)

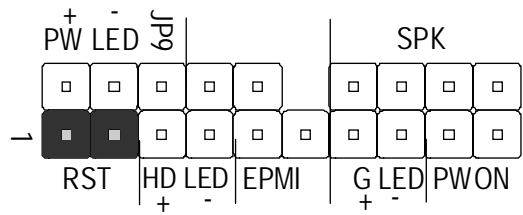

7. PC Speaker (SPK)

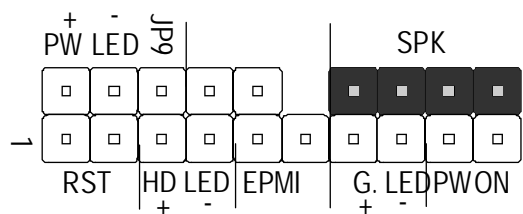

---

8. Line-Out and Mic-In header

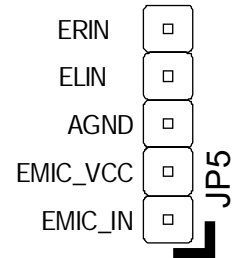

9. Front-panel USB connectors header

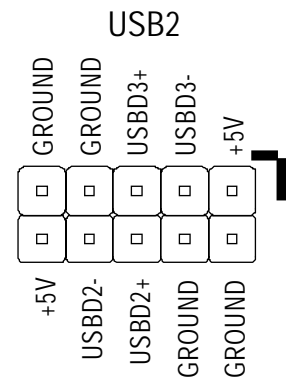

**Step 7**

**Connect IDE & Floppy Disk Drives**

1. IDE cable connector

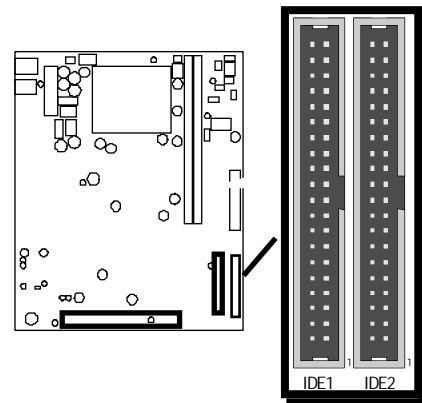

2. FDD cable connector

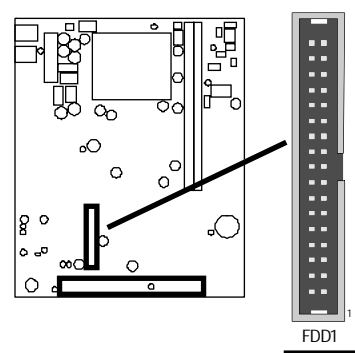

---

## Step 8

### Connect Other Internal Peripherals

1. COM 2 cable connector

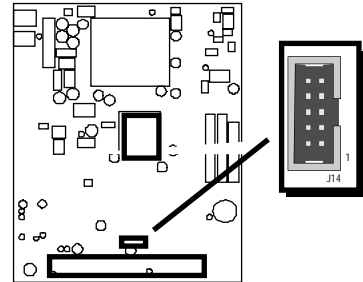

## Step 9

### Connect Power Supply

1. System power connector

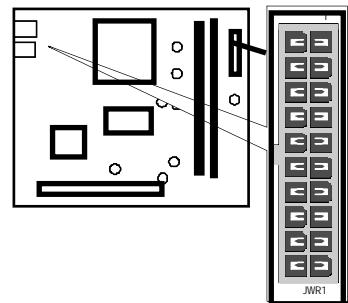

---

## **Step 10**

### **Install Add-on Cards in Expansion Slots**

1. PCI Card

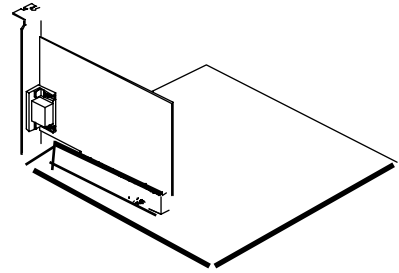

---

## Step 11

### Connect External Peripherals to Back-Panel

You are now ready to put the computer case back together and get on to the external peripherals connections to your system's back-panel.

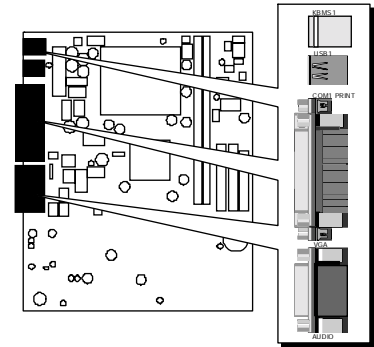

#### 1. PS/2 Mouse and Keyboard

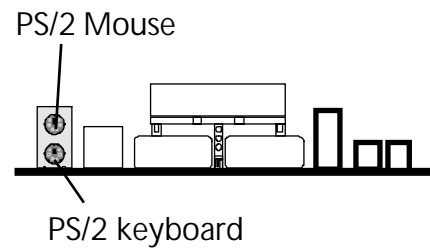

#### 2. USB Devices

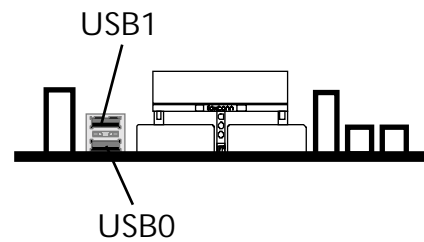

#### 3. Parallel Port

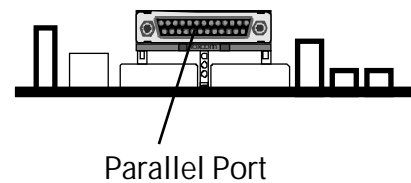

#### 4. COM1 Port

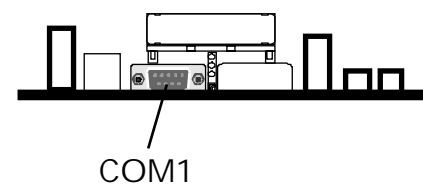

---

5. VGA connector

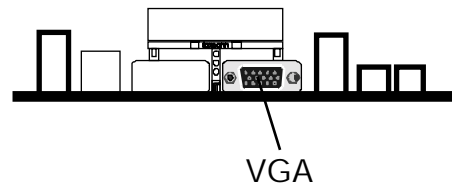

6. Audio Line\_out / Mic\_in

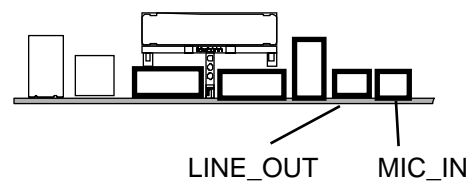

7. 1394 Port (Optional)

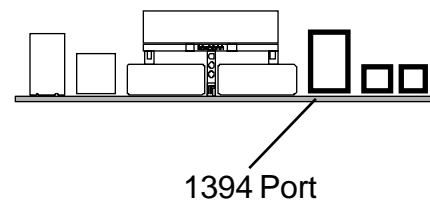

---

## Step 12

### First Time System Boot Up

To assure the completeness and correctness of your system installation, you may check the above installation steps once again before you boot up your system for the first time.

1. Insert a bootable system floppy disk (DOS 6.2x, Windows 95/98/NT, or others) which contains FDISK and FORMAT utilities into the FDD.
2. Turn on the system power.
3. First, you must use the FDISK utility to create a primary partition of the hard disk. You can also add an extended partition if your primary partition does not use all of the available hard disk space. If you choose to add an extended partition, you will have to create one or more logical partition(s) to occupy all the space available in the extended partition. The FDISK utility will assign a drive letter (i.e., C:, D:, E:,...) to each partition which will be shown in the FDISK program. After FDISK procedure, reboot your system by using the same system floppy disk.

**Note:** DOS 6.2x and Windows 95A can only support up to 2.1GB of HDD partition. If you use the FDISK utility with one of the operating systems mentioned above, you can only divide your HDD into partitions no larger than 2.1GB each.

4. Now, use the FORMAT utility to format all the partitions you've created. When formatting the primary partition (C:), make sure to use the FORMAT C: /S command.

**Note:** FORMAT C: /S can transfer all the necessary system files into the primary partition of your hard disk. Then, your HDD will become a bootable drive.

5. Install all the necessary drivers for CD-ROM, Mouse, etc.
6. Setup the complete operating system according to your OS installation guide.

---

## **Step 13**

### **Install Driver & Software Components**

Please note that all the system utilities and drivers are designed for Win 9x operating systems only. Make sure your Windows 9x operating system is already installed before running the drivers installation CD-ROM programs.

1. Insert the bundled CD-ROM into your CD-ROM drive. The auto-run program will display the drivers main installation window on screen.
2. Select the Mainboard related program.
3. Install VIA 4-in-1 drivers.
4. Install S3 VGA driver.
5. Install AC'97 2.1 Audio driver.
6. Return to the main installation window and select the Hardware Monitor related program.
7. Install the Hardware Monitor driver.

---

## 3.2 Jumper Settings

Several hardware settings are made through the use of jumper caps to connect jumper pins to the mainboard. Pin #1 could be located at any corner of each jumper; you just find a location marked with a white right angle, which stands for pin1#. There are several types of pin 1# shown as below:

3-pin and multi-pin (> 3) jumpers show as follows:

Pin #1 to the left:



Pin #1 on the top:





Pin #1 to the right:



Pin #1 on the bottom:



Jumpers with two pins are shown as  for Close [On] or  for Open [Off]. To Short jumper pins, simply place a plastic jumper cap over the desired pair of pins.

### **Caution!**

1. Do not remove the mainboard from its antistatic protective packaging until you are ready to install it.
2. Carefully hold the mainboard by its edges and avoid touching its components. When putting the mainboard down, place it on the top of its original packaging film and on an even surface, and components side up.
3. Wear an antistatic wrist strap or take other suitable measures to prevent electrostatic discharge (ESD) whenever handling this equipment.

---

## Jumper & Connector Guide

Use the mainboard layout on page 11 to locate CPU socket, memory slots, expansion slots, jumpers and connectors on the mainboard during installation. The following list will help you identify jumpers, slots, and connectors along with their assigned functions:

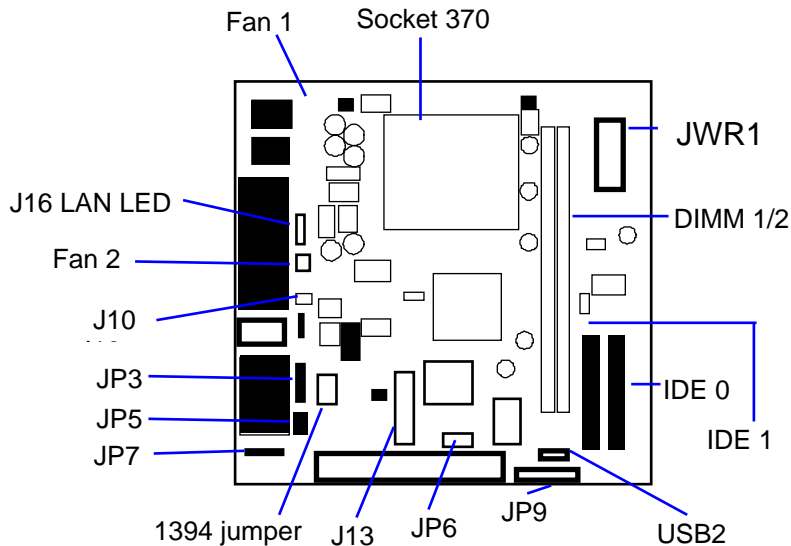

### **CPU/Memory/Expansion Slots**

- Socket 370 : CPU Socket for PPGA and FC-PGA 370 processors
- DIMM1/2 : Two DIMM Slots for 8, 16, 32, 64, 128, 256, and 512 MB of 3.3V SDRAM
- PCI : One 32-bit PCI Expansion Slots

### **Jumpers**

- J10 : Clear CMOS
- J16 : LAN LED

### **Back-panel Connectors**

- KB : PS/2 Keyboard
- MS : PS/2 Mouse
- USB : 2 × USB (Universal Serial Bus)

---

COM1 : Serial Port 1 (DB9 male)  
VGA : VGA Port (DB15 female)  
PRINTER : Parallel Port (DB25 female)  
LINE-OUT : Line-Out Port  
MIC-IN : Mic-In Port

***Front-Panel Connectors (JP9,JP5, and USB2)***

PWON : ATX Power On/Off Momentary Type Switch  
EPMI : Hardware System Management Interface Momentary  
Type switch  
G LED : Green LED (ON when system stays in power saving mode)  
HD LED : IDE Drive Active LED  
PW LED : System Power LED  
RST : Hardware Reset Switch  
SPEAKER : Housing Internal Speaker  
L-OUT/MIC : Front-panel Line-Out and Mic-In Header  
USB : Front-panel USB Connector Header

***Internal Peripherals Connectors***

FDD : Floppy Disk Drive Interface  
IDE1 : IDE Primary Interface (Dual-channel)  
IDE2 : IDE Secondary Interface (Dual-channel)

***Other Connectors:***

JWR1 : ATX Power (20-pin header)  
FAN1 : CPU Cooling Fan Power  
FAN2 : AGP Housing Cooling Fan Power  
  
JP6 : COM2 Connector  
J16 : LAN LED  
  
JP3 : LINE OUT  
JP5 : LINE-In & MIC-In  
JP7 : CD-in

---

## ● Clear CMOS (J10)

J10 is used to clear CMOS data. Clearing CMOS will result in the permanent erasing of previous system configuration settings and the restoration of original (factory-set) system settings.

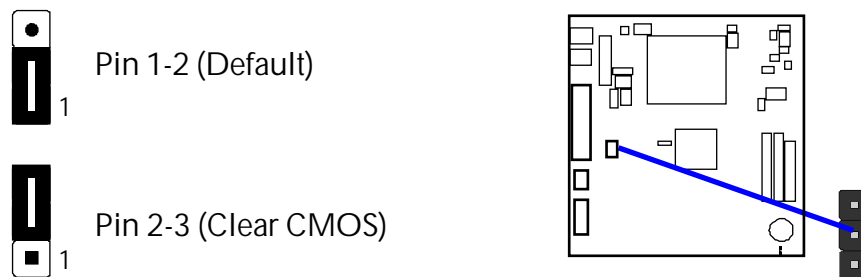

- Step 1. Turn off the system power (PC-> Off).
- Step 2. Remove jumper cap from J10 pins 1-2.
- Step 3. Place the jumper cap on J10 pin 2-3 for a few seconds.
- Step 4. Return the jumper cap to pin 1-2.
- Step 5. Turn on the system power (PC-> On).

---

## ☛ Back-Panel Connectors

### ● PS/2 Keyboard & PS/2 Mouse Connectors

Two 6-pin female PS/2 keyboard & Mouse connectors are located at the rear panel of mainboard. Depending on the computer housing you use (desktop or minitower), the PS/2 Mouse connector is situated at the top of the PS/2 Keyboard connector when the mainboard is laid into a desktop, as opposed to a minitower where the PS/2 Mouse connector is located at the right of the PS/2 Keyboard. Plug the PS/2 keyboard and mouse jacks into their corresponding connectors.

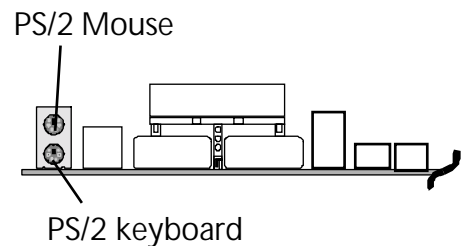

### ● USB0/USB1 Port Connectors

Two female connectors USB0/USB1 share the same USB (Universal Serial Bus) bracket at the rear panel of your mainboard. Plug each USB device jack into an available USB0/USB1 connector.

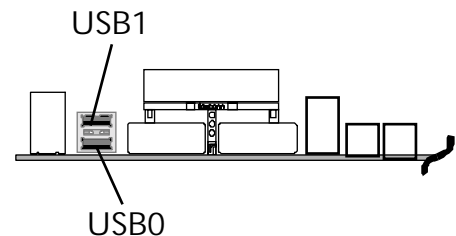

### ● COM1 Connector

This mainboard can accommodate one serial device on COM1. Attach a serial device cable to the DB9 serial port COM1 at the back-panel of your computer.

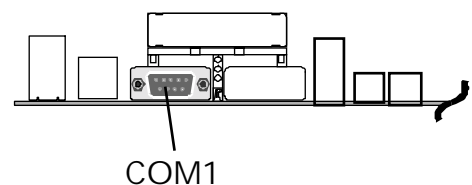

### ● VGA Connector

A 15-pin VGA connector is located at the rear panel of mainboard.

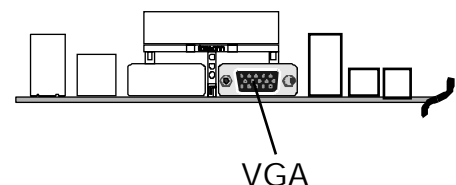

### ● Parallel Port Connector

One DB25 female parallel connector is located at the rear panel of the mainboard. Plug the connection cable from your parallel device (printer, scanner, etc.) into this connector.

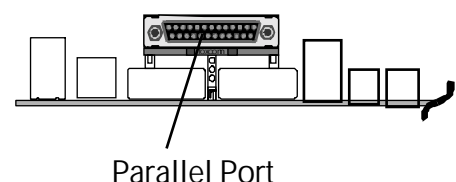

---

## ● Line-Out

Line-Out is a stereo output port through which the combined signal of all internal and external audio sources on the board is output. It can be connected to 1/8-inch TRS stereo headphones or to amplified speakers.

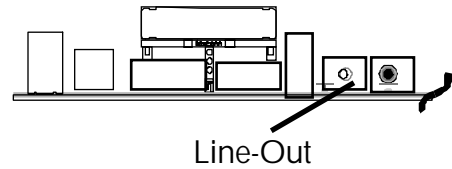

## ● Mic-In

MIC-IN is a 1/8-inch jack that provides a mono input. It can use a dynamic mono or stereo microphone with a resistance of not more than 600 Ohms.

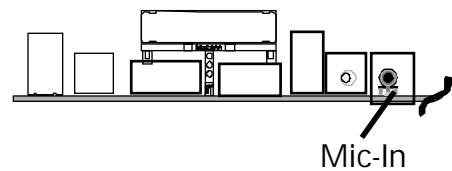

---

## ☛ Front-Panel Connectors

### ● ATX Power On/Off Switch Connector (PWON)

The Power On/Off Switch is a momentary-type switch used for turning on or off the system's ATX power supply. Attach the connector cable from the Power Switch to the 2-pin PWR header on the mainboard.

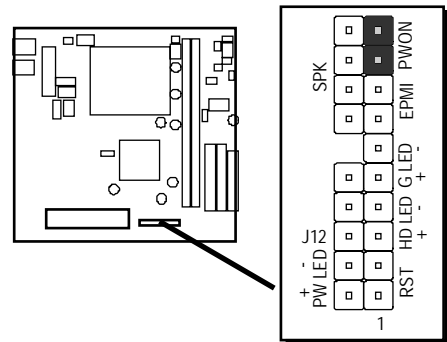

**Note :** Please note the Speaker and all the LED connectors are directional. If your chassis's LED does not light up during running, please simply change to the opposite direction.

### ● EPMI Connector (EPMI)

Hardware System Management Interface (EPMI) header may attach to a 2-pin momentary switch. Press the EPMI switch to force the system into power saving mode; press again to resume normal operation.

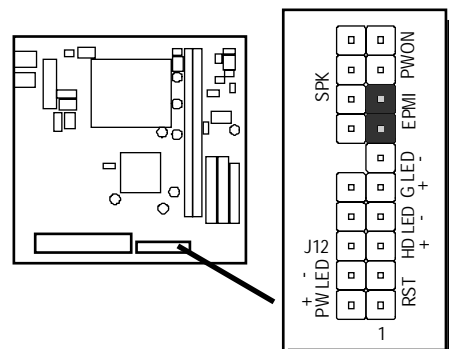

### ● Green LED Connector (G LED)

The Green LED (G LED) indicates that the system is currently in one of the power saving mode (Doze/Standby/Suspend). When the system resumes to normal operation mode, the Green LED will go off. Attach a 2-pin Green LED cable to GREEN LED header.

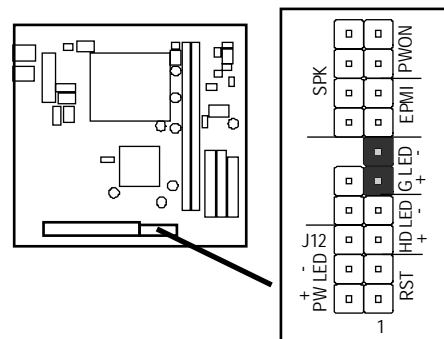

---

### ● HDD LED Connector (HD LED)

Attach the connector cable from the IDE device LED to the 2-pin HDD LED header. The HDD LED lights up whenever an IDE device is active.

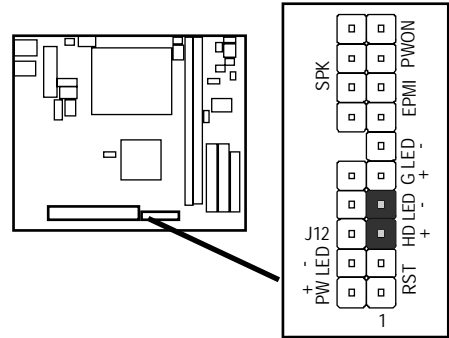

### ● PWR LED Connector (PW LED)

Attach the 3-pin Power-LED connector cable from the housing front-panel to the PWR header on the mainboard. The power LED stays light while the system is running.

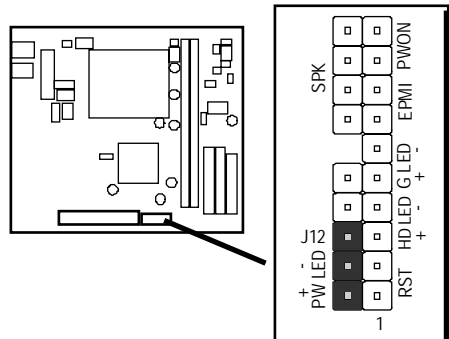

### ● Hardware Reset Connector (RST)

Attach the 2-pin hardware reset switch cable to the RST header. Pressing the reset switch causes the system to restart.

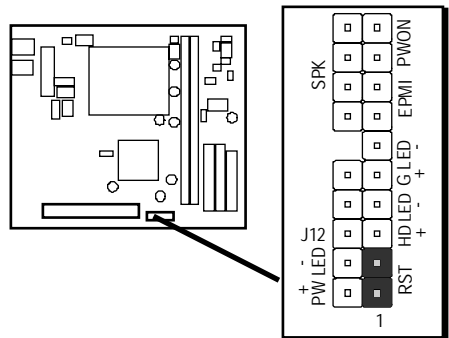

### ● Speaker Connector (SPK)

Attach the PC speaker cable from the case to the 4-pin speaker connector (SPK).

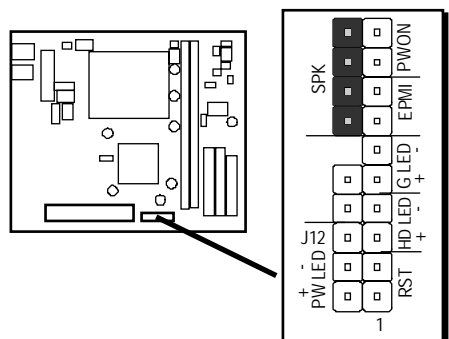

---

## ● Line-Out and Mic-In Header (JP5)

This header is used to connect the cable attached to Line-Out and Mic-In phone jacks which are mounted on front-panel. This header shares the same signal with Line-Out/Mic-In on back-panel.

## ⑨ Front-Panel USB Connector Header (USB2)

This header is used to connect the cable attached to USB connectors which are mounted on front-panel. USB connectors on front-panel share the same signal with USB connectors on back-panel; only a USB connector is available on front-panel or on back-panel to each USB2.

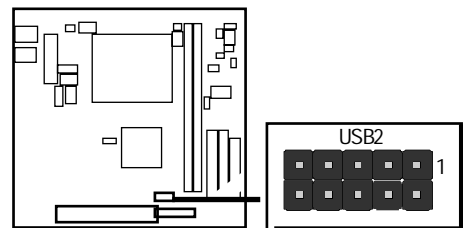

Pins Assignment:

1 = +5V	3 = USB2-
5 = USB2+	7 = GROUND
9 = GROUND	
2 = GROUND	4 = GROUND
6 = USB2+	8 = USB2-
10 = +5V	

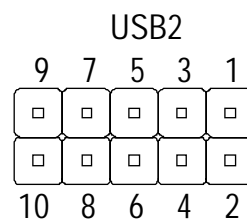

---

## ☞ **Internal Peripherals Connectors**

### ● **Enhanced IDE Ports and Floppy Connector**

The mainboard features two 40-pin dual-channel IDE device connectors (IDE1/IDE2) providing support to up to four IDE devices, such as CD-ROM and Hard Disk Drives (H.D.D.). This mainboard also includes one 34-pin floppy disk controller (FDC) to accommodate the Floppy Disk Drive (F.D.D.). Moreover, this mainboard comes with one 80pin ATA66 ribbon cable to connect to IDE H.D.D. and one 34-pin ribbon cable for F.D.D. connection.

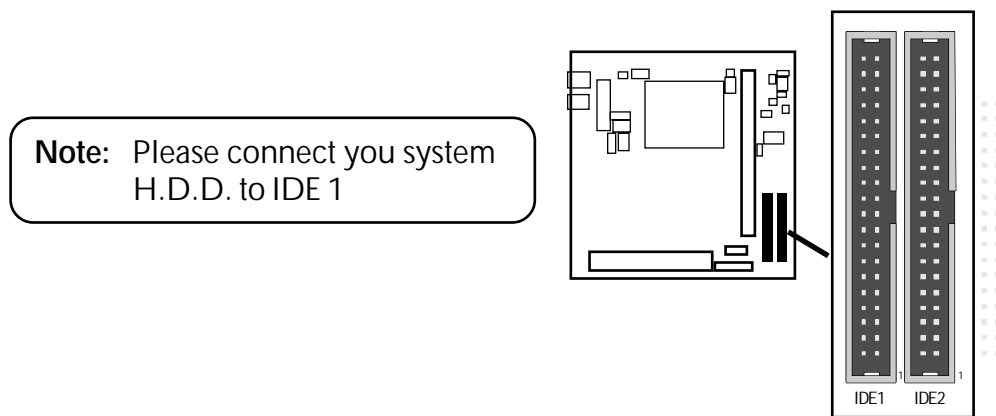

**Important:** Ribbon cables are directional, therefore, make sure to always connect with the red cable stripe on the same side as pin #1 of the IDE1/IDE2 or FDC connector on the mainboard.

---

## Other Connectors

### ● ATX Power Supply Connector (JWR1)

Locate the 20-pin male header ATX power connector (JWR1) on your mainboard. Plug the power cable from the ATX power supply unit directly into JWR1 ATX power supply connector.

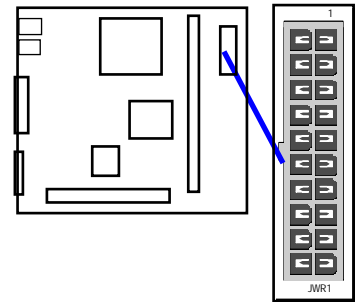
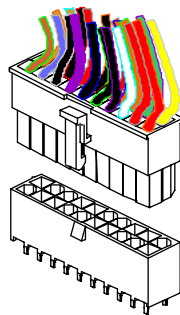

**Note 1:** The ATX power connector is directional and will not go in unless the guides match perfectly making sure that pin#1 is properly positioned.

**Note 2:** Make sure the latch of the ATX power connector clicks into place to ensure a solid attachment.

**Note 3:** Your ATX power supply must be supplied to ACPI +5V standby power and at least 720mA compatible.

**Note 4:** Make sure your power supply have enough power for higher speed processor installed.

### ● Cooling Fan Connectors for CPU FANS (FAN1), & AGP FAN Chassis (FAN2)

The mainboard provides three onboard 12V cooling fan power connectors to support CPU FANS (FAN1), and AGP Chassis device (FAN2) cooling fans.

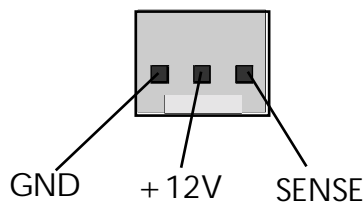

**Note:** Both cable wiring and type of plug may vary depending on the fan maker. Keep in mind that the red wire should always be connected to the +12V header, and the black wire, to the ground (GND) header.

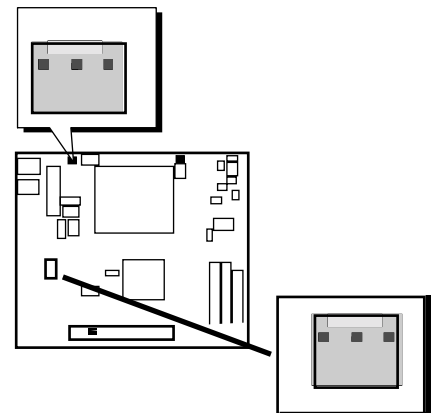

---

## ● COM2 Connector (JP6)

Pins Assignment:

1=DCD2	3=TX2	10	□	□	9
5=GROUND	7=RTS2	8	□	□	7
9=RI2		6	□	□	5
2=RX2	4=DTR2	4	□	□	3
6=DSR2	8=CTS2	2	□	□	1
10=KEY					

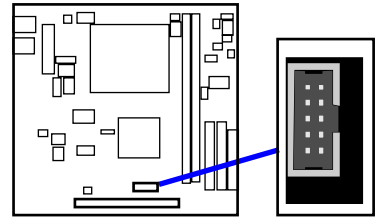

---

### ● Audio Connector LINE\_OUT (JP3)

Port JP3 can be used to connect a stereo audio output.

Pins Assignment:

- 1 = LINE OUT L
- 2 = PLINE OUT L
- 4 = PLINE OUT R
- 5 = LINE OUT R
- 3 = GND

### ● Audio Connector MIC\_In (JP5)

You would use this connector when running the voice mail software on your system for audio input.

Pins Assignment:

- 1= MIC-IN
- 2= MIC-VCC
- 4= LINE-IN L
- 5= LINE-IN R
- 3= GND

### ● Audio Connector CD\_In (JP7)

Port JP7 is used to attach an audio connector cable from the CD-ROM drive.

Pins Assignment:

- 1=CD\_L
- 2=CD\_GND
- 3=CD\_GND
- 4=CD\_R

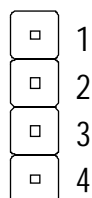

---

### 3.3 System Memory Configuration

The mainboard has two 168-pin DIMM slots that allow you to install from 16MB up to 1GB of system memory with PC100/133 SDRAM (Synchronous DRAM). Each DIMM (Dual In-line Memory Module) slot can accommodate 16MB, 32MB, 64MB, 128MB, 256MB, and 512MB of 3.3V single or double side 64 or 72-bit wide data path SDRAM modules.

The mainboard supports data integrity algorithms including EC (Error Checking) and ECC (Error Checking and Correction) in the memory array. In EC mode, single and multiple bit error detection is provided. In ECC mode, when the memory is being read from DRAM, provides both error checking and correction of the data.

#### Install Memory:

Install memory in any or all of the slots and in any combination shown as follows.

DIMM Slot	Memory Modules	Module Quantity
DIMM 1	16MB, 32MB, 64MB, 128MB, 256MB, 512MB 168-pin 3.3V SDRAM DIMM	x 1
DIMM 2	16MB, 32MB, 64MB, 128MB, 256MB, 512MB 168-pin 3.3V SDRAM DIMM	x 1

**Note:** You do not need to set any jumper to configure memory since the BIOS utility can detect the system memory automatically. You can check the total system memory value in the BIOS Standard CMOS Setup menu.

#### Upgrade Memory:

You can easily upgrade the system memory by inserting additional SDRAM modules in available DIMM slots. The total system memory is calculated by simply adding up the memory in all DIMM slots. After upgrade, the new system memory value will automatically be computed and displayed by the BIOS Standard CMOS Setup menu.

## 4 SOFTWARE UTILITY

---

### 4.1 Mainboard CD Overview

To start your mainboard CD disc, just insert it into your CD-ROM drive, and the CD Autorun screen should appear. If the Autorun screen does not appear, double click or run D:\Autorun.exe (assuming that your CD-ROM drive is D:)

#### Navigation Bar Description :

- ⚙ **Install Mainboard Software** – Installing 4 in 1, AGP, and Audio drivers.
- ⚙ **Install VIA Hardware Monitor** – Installing Hardware Monitor driver.
- ⚙ **Manual** – BN-800E Mainboard User's Manual in PDF format.
- ⚙ **Browse this CD** – Allows you to see the contents of this CD.
- ⚙ **Quit** – Close this CD.

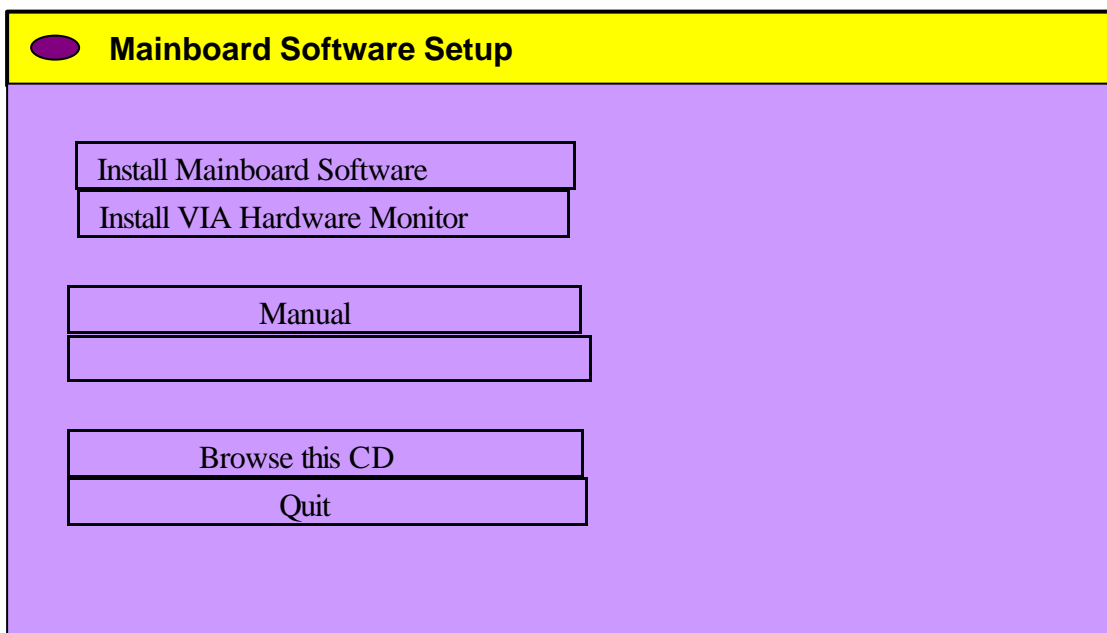

**Note:** The CD contents attached in the BN-800E mainboard are subject to change without notice.

---

## 4.2 Install VIA 4 in 1 Driver

Insert the attached CD into your CD-ROM drive, and the CD Autorun screen should appear. If the Autorun screen does not appear, double click on Autorun icon in **MY Computer** to bring up **Mainboard Software Setup** screen. Select the item using your pointing device (e.g. mouse) on the "**Install Mainboard Software**" bar.

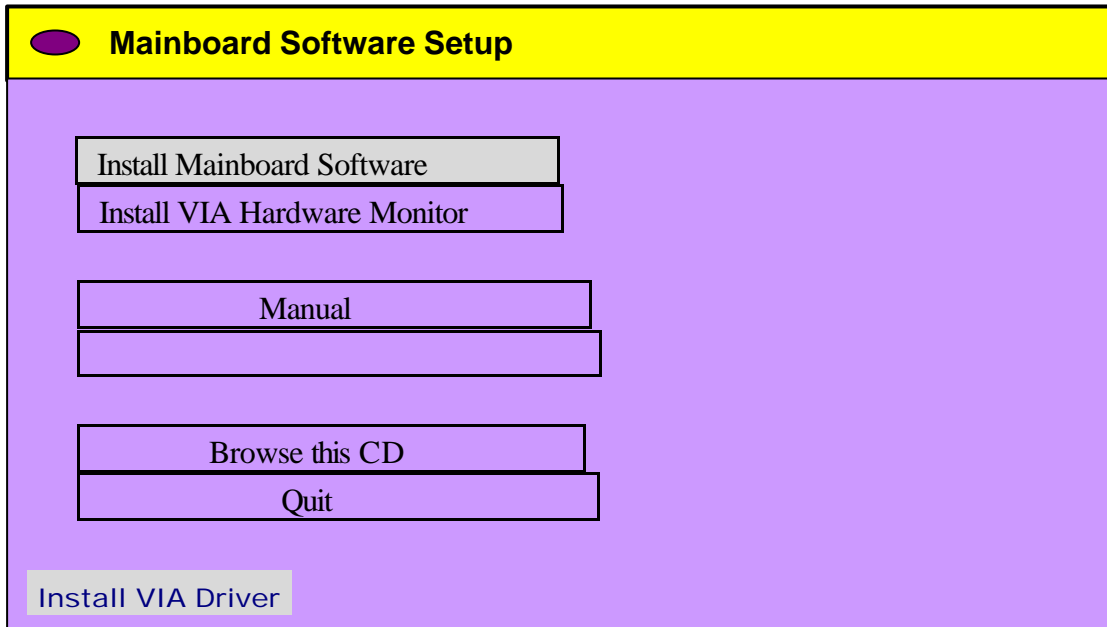

Then **Mainboard Drivers & Utilities** windows will appear on your screen. Click on the "**Install VIA driver**" bar to install VIA 4 in 1 driver.

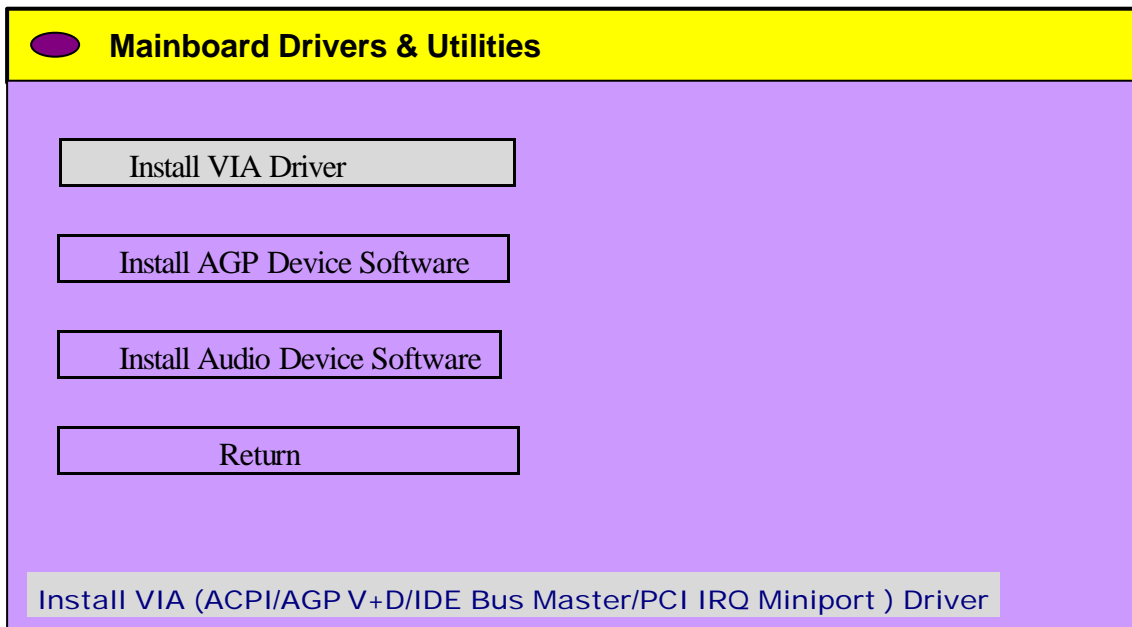

Once you make your selection, a Setup window will automatically runs the Installation.

When the files are done copying, make sure you **reboot** the system to Insure that the files are installed correctly.

---

### 4.3 Install AGP Device Software

Insert the attached CD into your CD-ROM drive, and the CD Autorun screen should appear. If the Autorun screen does not appear, double click on Autorun icon in **MY Computer** to bring up **Mainboard Software Setup** screen. Select the item using your pointing device (e.g. mouse) on the “**Install Mainboard Software**” bar.

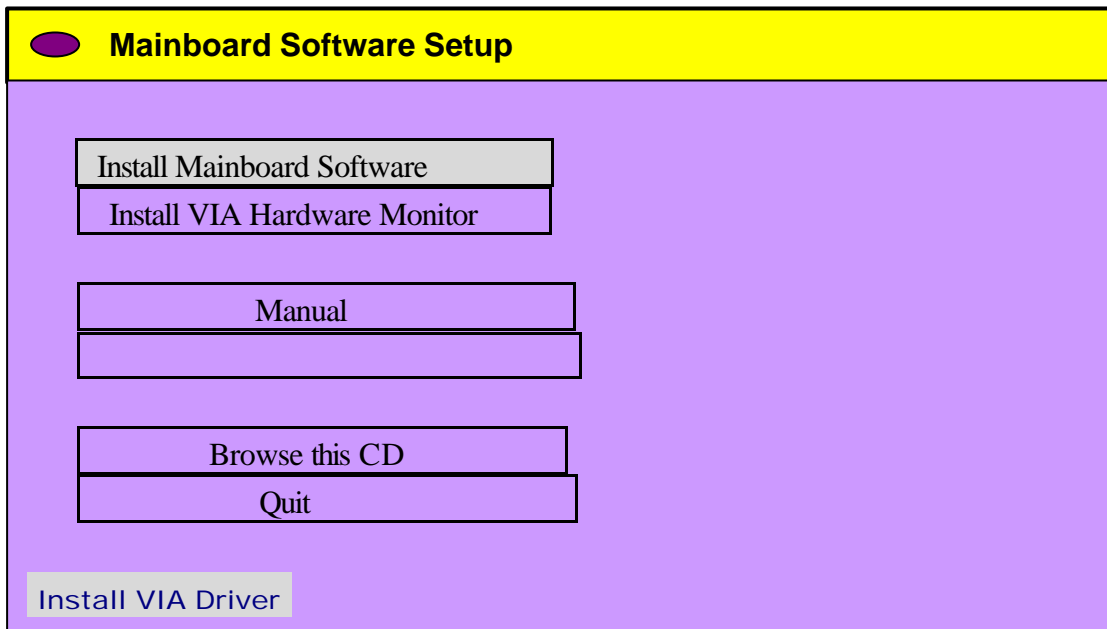

Then **Mainboard Drivers & Utilities** windows will appear on your screen. Click on the “**Install AGP Device Software**” bar to install AGP driver.

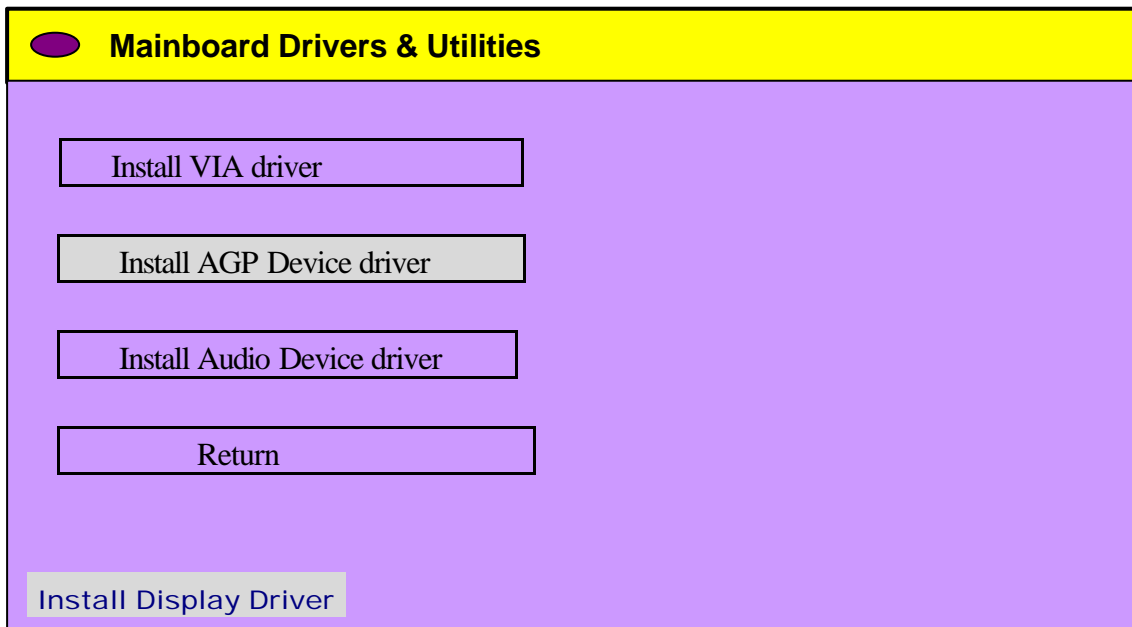

Once you make your selection, a Setup window will automatically runs the Installation.

When the files are done copying, make sure you **reboot** the system to Insure that the files are installed correctly.

---

## 4.4 Install Audio Device Software

Insert the attached CD into your CD-ROM drive, and the CD Autorun screen should appear. If the Autorun screen does not appear, double click on Autorun icon in **MY Computer** to bring up **Mainboard Software Setup** screen. Select the item using your pointing device (e.g. mouse) on the "**Install Mainboard Software**" bar.

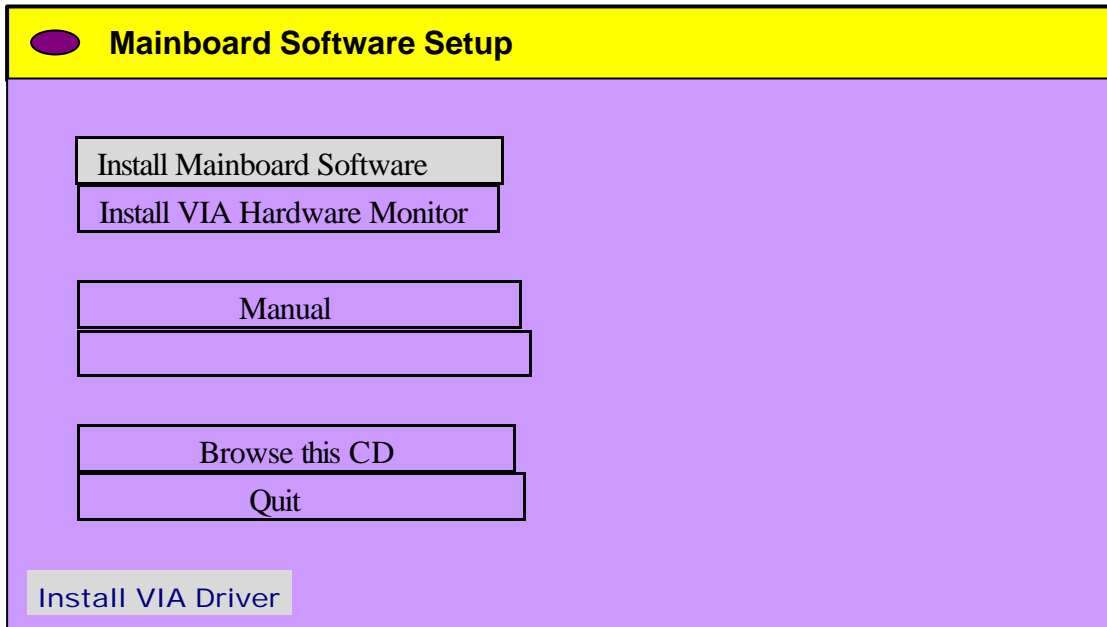

Then **Mainboard Drivers & Utilities** windows will appear on your screen. Click on the "**Install Audio Device Software**" bar to install AGP driver.

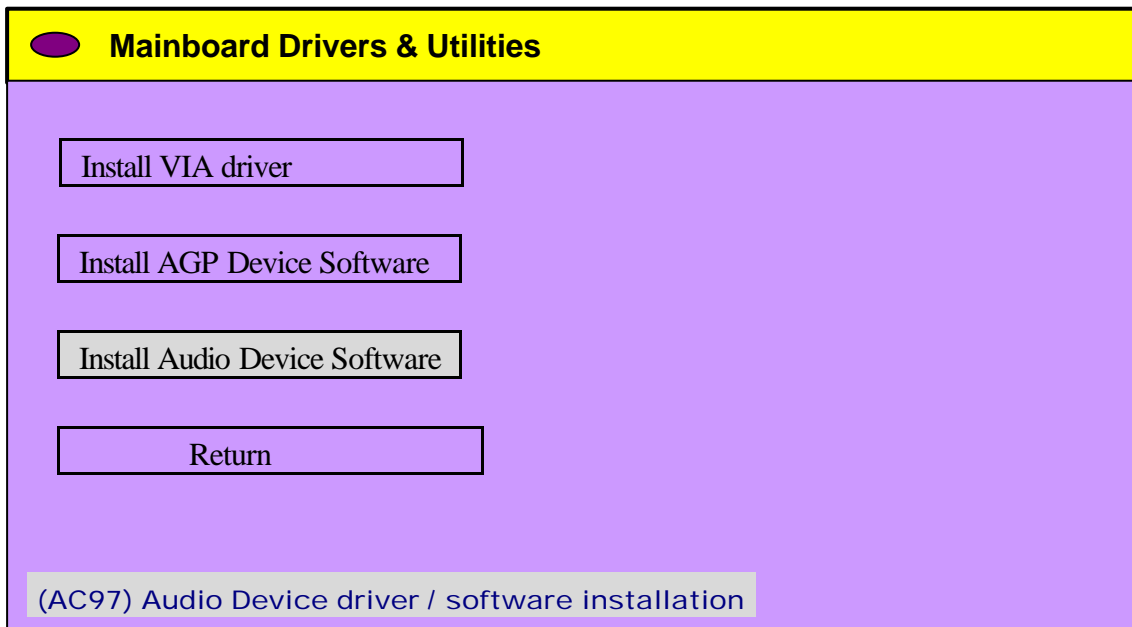

Once you make your selection, a Setup window will automatically runs the Installation.

When the files are done copying, make sure you **reboot** the system to Insure that the files are installed correctly.

---

## 4.5 Install VIA Hardware Monitor Device Software

Insert the attached CD into your CD-ROM drive, and the CD Autorun screen should appear. If the Autorun screen does not appear, double click on Autorun icon in **MY Computer** to bring up **Mainboard Software Setup** screen. Select the item using your pointing device (e.g. mouse) on the “**Install VIA Hardware Monitor**” bar.

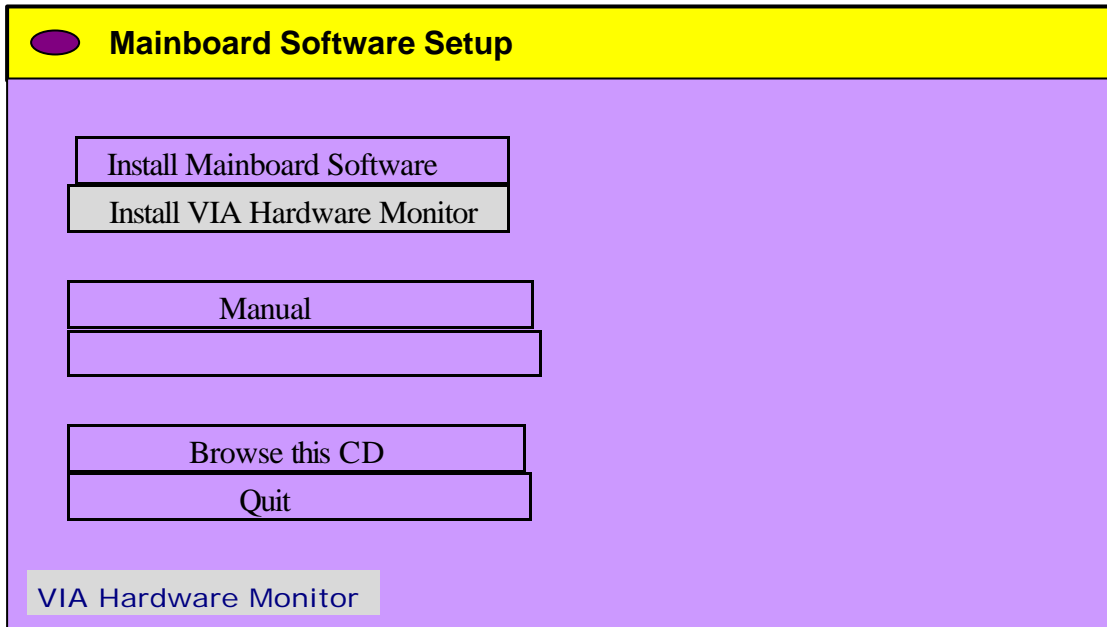

Once you make your selection, a Setup window will automatically runs the Installation.

When the files are done copying, make sure you **reboot** the system to Insure that the files are installed correctly.

---

## 4.6 View the User's Manual

Insert the attached CD into your CD-ROM drive, and the CD Autorun screen should appear. If the Autorun screen does not appear, double click on Autorun icon in **MY Computer** to bring up **Mainboard Software Setup** screen. Select the item using your pointing device (e.g. mouse) on the "**Manual**" bar.

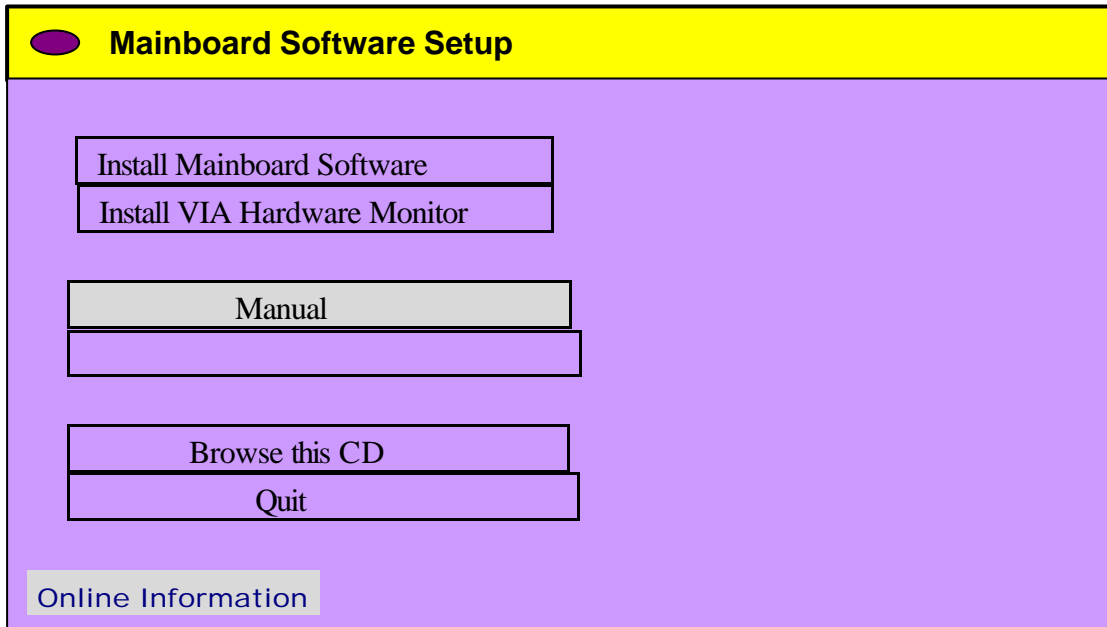

Then **Online Information** windows will appear on your screen. Click on the "**Install Acrobe Reader**" bar if you need to install Acrobe reader.

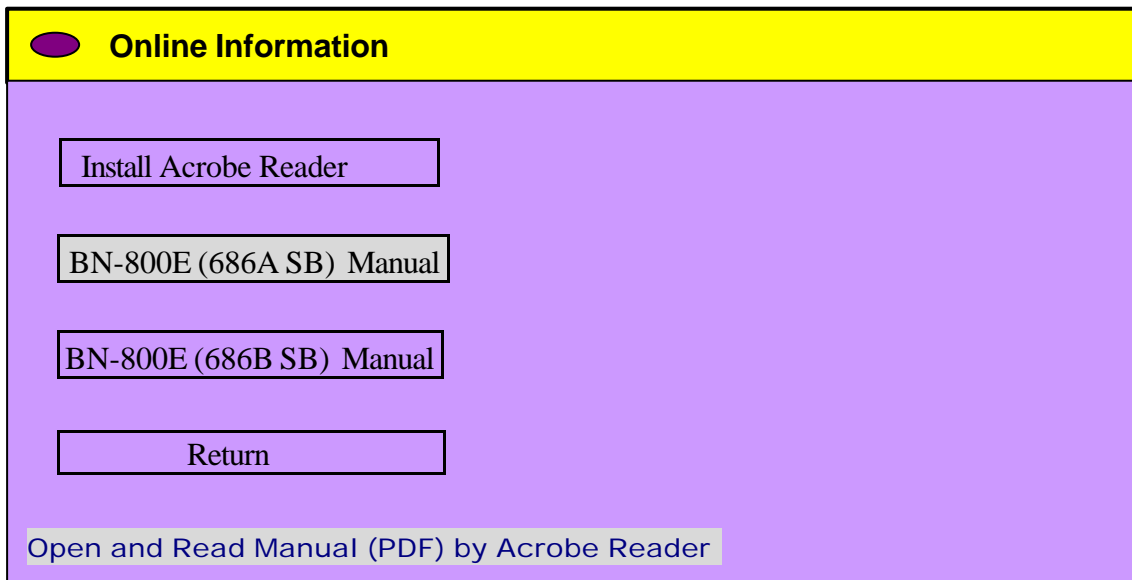

Then click on "BN-800E Manual" bar to view BN-800E User's Manual.

# 5 BIOS SETUP

---

BIOS ROM has a built-in Setup program that allows users to modify the basic system configuration. This information is stored in battery-backed RAM so that it retains the Setup information even if the system power is turned off.

The system BIOS is managing and executing a variety of hardware related functions in the system, including:

- System date and time
- Hardware execution sequence
- Power management functions
- Allocation of system resources

## 5.1 Enter the BIOS

To enter the BIOS (Basic Input / Output System) utility, follow these steps:

- Step 1.** Power on the computer, and the system will perform its POST (Power-On Self Test) routine checks.
- Step 2.** Press < Del > key immediately, or at the following message:  
"Press DEL to enter SETUP"  
,or simultaneously press < Ctrl > , < Alt > , < Esc > keys

**Note 1.** If you miss trains of words meationed in step2 (the message disappears before you can respond) and you still wish to enter BIOS Setup, restart the system and try again by turning the computer OFF and ON again or by pressing the < RESET > switch located at the computer's front-panel. You may also reboot by simultaneously pressing the < Ctrl > , < Alt > , < Del > keys.

**Note 2.** If you do not press the keys in time and system does not boot, the screen will prompt an error message, and you will be given the following options:

**"Press F1 to Continue, DEL to Enter Setup"**

- Step 3.** As you enter the BIOS program, the CMOS Setup Utility will prompt you the Main Menu, as shown in the next section.

---

## 5.2 The Main Menu

Once you enter the AwardBIOS(tm) CMOS Setup Utility, the Main Menu will appear on the screen. The Main Menu allows you to select from several setup functions and two exit choices. Use the arrow keys to select among the items and press < Enter > to accept and enter the sub-menu.

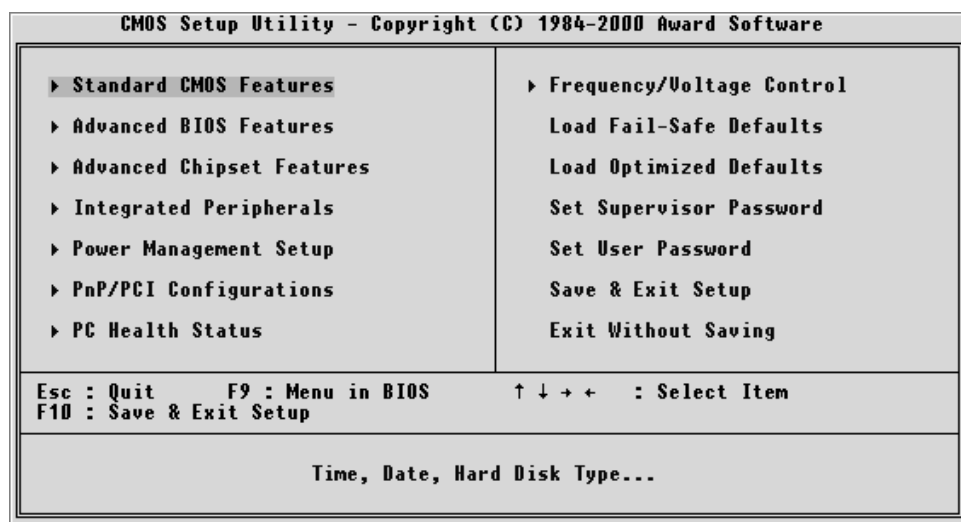

Note that a brief description of each highlighted selection appears at the bottom of the screen.

### **Setup Items**

The main menu includes the following main setup categories. Recall that some systems may not include all entries.

#### **Standard CMOS Features**

Use this menu for basic system configuration.

#### **Advanced BIOS Features**

Use this menu to set the Advanced Features available on your system.

#### **Advanced Chipset Features**

Use this menu to change the values in the chipset registers and optimize your system's performance.

---

### ***Integrated Peripherals***

Use this menu to specify your settings for integrated peripherals.

### ***Power Management Setup***

Use this menu to specify your settings for power management.

### ***PnP / PCI Configuration***

This entry appears if your system supports PnP / PCI.

### ***PC Health Status***

This entry shows the current system temperature, Voltage, and FAN speed.

### ***Frequency/Voltage Control***

Use this menu to specify your settings for frequency/voltage control.

### ***Load Fail-Safe Defaults***

Use this menu to load the BIOS default values for the minimal/stable performance of your system to operate.

### ***Load Optimized Defaults***

Use this menu to load the BIOS default values that are factory-set for optimal performance system operation. While Award has designed the custom BIOS to maximize performance, the factory has the right to change these defaults to meet users' needs.

### ***Supervisor / User Password***

Use this menu to change, set, or disable supervisor/user password. It allows you to limit access to the system and Setup, or only to Setup.

### ***Save & Exit Setup***

Save CMOS value changes in CMOS and exit from setup.

### ***Exit Without Saving***

Abandon all CMOS value changes and exit from setup.

---

## ☛ **Standard CMOS Features**

The items in Standard CMOS Setup Menu are divided into 10 categories. Each category includes no, one or more than one setup items. Use the arrow keys to highlight the item and then use the < PgUp > or < PgDn > keys to select the value you want in each item.

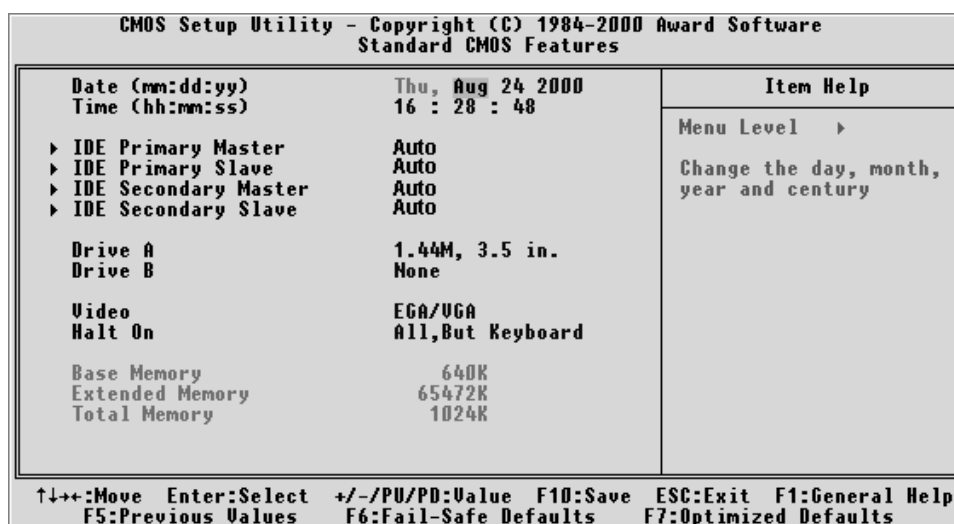

### **Date**

< Month > < DD > < YYYY >

Set the system date. Note that the 'Day' automatically changes when you set the date.

### **Time**

< HH : MM : SS >

The time is converted based on the 24-hour military-time clock. For example, 5 p.m. is 17:00:00.

### **IDE Primary Master**

Options are in its sub-menu.

Press < Enter > to enter the sub-menu of detailed options.

### **IDE Primary Slave**

Options are in its sub-menu.

Press < Enter > to enter the sub-menu of detailed options.

---

### **IDE Secondary Master**

Options are in its sub-menu.

Press < Enter > to enter the sub-menu of detailed options.

### **IDE Secondary Slave**

Options are in its sub menu.

Press < Enter > to enter the sub-menu of detailed options.

### **Drive A/Drive B**

Select the type of floppy disk drive installed in your system.

- The choice: None, 360K, 5.25 in, 1.2M, 5.25 in, 720K, 3.5 in, 1.44M, 3.5 in, or 2.88M, 3.5 in

### **Video**

Select the default video device.

- The choice: EGA/VGA, CGA 40, CGA 80, or MONO

### **Halt On**

Select the situation in which you want the BIOS to stop the POST process and notify you.

- The choice: All Errors, No Errors, All, But Keyboard, All, But Diskette, All, or But Disk/Key

### **Base Memory**

Displays the amount of conventional memory detected during boot up.

- The choice: N/A

### **Extended Memory**

Displays the amount of extended memory detected during boot up.

- The choice: N/A

### **Total Memory**

Displays the total memory available in the system.

- The choice: N/A

---

\*\*\*\*\*

## **IDE Adapters**

The IDE adapters control the hard disk drive. Use a separate sub-menu to configure each hard disk drive.

### **IDE HDD Auto-Detection**

Press < Enter > to auto-detect HDD on this channel. If detection is successful, it fills the remaining fields on this menu.

- Press Enter

### **IDE Primary Master**

Selecting 'manual' lets you set the remaining fields on this screen and select the type of fixed disk. "User Type" will let you select the number of cylinders, heads, etc., Note: PRECOMP=65535 means NONE!

- The choice: None, Auto, or Manual.

### **Access Mode**

Choose the access mode for this hard disk.

- The choice: Normal, LBA, Large, or Auto.

### **Capacity**

Disk drive capacity (Approximated). Note that this size is usually slightly greater than the size of a formatted disk given by a disk checking program.

- Auto-Display your disk drive size.

*The following options are selectable only if the 'IDE Primary Master' item is set to 'Manual'*

### **Cylinder**

Set the number of cylinders for this hard disk.

- Min = 0, Max = 65535

### **Head**

Set the number of read/write heads.

- Min = 0, Max = 255

---

**Precomp**

Warning: Setting a value of 65535 means no hard disk.

➤ Min = 0, Max = 65535

**Landing zone**

Set the Landing zone size.

➤ Min = 0, Max = 65535

**Sector**

Number of sector per track.

➤ Min = 0, Max = 255

\*\*\*\*\*

## ➤ **Advanced BIOS Features**

This section allows you to configure your system for basic operation. You have the opportunity to select the system's default speed, boot-up sequence, keyboard operation, shadowing, and security.

CMOS Setup Utility - Copyright (C) 1984-2000 Award Software Advanced BIOS Features		
Virus Warning	Disabled	<b>Item Help</b>  Menu Level ▶  Allows you to choose the VIRUS warning feature for IDE Hard Disk boot sector protection. If this function is enabled and someone attempt to write data into this area, BIOS will show a warning message on screen and alarm beep
CPU Internal Cache	Enabled	
External Cache	Enabled	
CPU L2 Cache ECC Checking	Enabled	
Processor Number Feature	Enabled	
Quick Power On Self Test	Disabled	
First Boot Device	Floppy	
Second Boot Device	HDD-0	
Third Boot Device	LS120	
Boot Other Device	Enabled	
Swap Floppy Drive	Disabled	
Boot Up Floppy Seek	Enabled	
Boot Up NumLock Status	On	
Gate A20 Option	Normal	
Typematic Rate Setting	Enabled	
Typematic Rate (Chars/Sec)	6	
Typematic Delay (Msec)	250	
Security Option	Setup	
OS Select For DRAM > 64MB	Non-OS2	
Video BIOS Shadow	Enabled	
C8000-CBFFF Shadow	Disabled	
CC000-CFFFF Shadow	Disabled	
D0000-D3FFF Shadow	Disabled	
D4000-D7FFF Shadow	Disabled	
D8000-DBFFF Shadow	Disabled	
DC000-DEFFF Shadow	Disabled	

↑↓←→:Move Enter:Select +/-/PU/PD:Value F10:Save ESC:Exit F1:General Help  
 F5:Previous Values F6:Fail-Safe Defaults F7:Optimized Defaults

### **Virus Warning**

Allows you to choose the VIRUS Warning feature for IDE Hard Disk boot sector protection. If this function is enables and someone attempts to write data into this area, BIOS will show a warning message on screen, and an alarm beep.

**Enabled** Activates automatically when the system boots up, causing a warning message to appear when anything attempts to access the boot sector or hard disk partition table.

**Disabled** No warning message will appear when anything attempts to access the boot sector or hard disk partition table.

➤ The choice: Enabled or Disabled.

### **CPU Internal Cache**

This item enables CPU external cache to speed up memory access.

➤ The choice: Enabled or Disabled.

---

### **External Cache**

This item enables CPU secondary cache to speed up memory access.

- The choice: Enabled or Disabled.

### **CPU L2 Cache ECC Checking**

When you select Enabled, memory checking is enabled when the external cache contains ECC SRAMs.

- The choice: Enabled or Disabled.

### **Processor Number Feature**

Allows you to make Pentium III Processor Serial Number enabled/disabled.

- The choice: Enabled, or Disabled.

### **Quick Power On Self Test**

This item speeds up Power-On Self Test (POST) after you power on the computer. If it is set to enabled, BIOS will shorten or skip some check items during POST.

- The choice: Enabled, or Disabled.

### **First/Second/Third Boot Device**

The BIOS attempts to load the operating system from the devices in the sequence selected in these items.

- The Choice: Floppy, LS120, HDD-0, SCSI, CDROM, HDD-1, HDD-2, HDD-3, ZIP100, LAN, or Disabled.

### **Boot Other Device**

Select Your Boot Device Priority.

- The choice: Enabled or Disabled.

### **Swap Floppy Drive**

If the system has two floppy drives, you can swap the logical drive name assignment.

- The choice: Enabled or Disabled.

### **Boot Up Floppy Seek**

Seeks disk drives during boot-up. Disabling speed boots up.

- The choice: Enabled or Disabled.

---

### **Boot Up NumLock Status**

Selects power-on state for NumLock.

- The choice: Off or On.

### **Gate A20 Option**

This entry allows you to select how the gate A20 is handled. The gate A20 is a device used for above 1MByte of address memory. Initially, the gate A20 was handled via a pin on the keyboard. Today, while a keyboard still provides this support, it is more common and much faster in setting to Fast for the system chipset to provide support for gate A20.

- The choice: Normal, or Fast.

### **Typematic Rate Setting**

Keystrokes repeat at a rate determined by the keyboard controller. When this controller enabled, the typematic rate and typematic delay can be selected.

- The choice: Enabled or Disabled.

### **Typematic Rate (Chars/Sec)**

This item sets how many times the keystroke will be repeated in a second when you hold the key down.

- The choice: 6, 8, 10, 12, 15, 20, 24, or 30.

### **Typematic Delay (Msec)**

Sets the delay time after the key is held down before it begins to repeat the keystroke.

- The choice: 250, 500, 750, or 1000.

### **Security Option**

Select whether the password is required every time the system boots or only when you enter setup.

**System** The system will not boot and access to Setup will be denied if the correct password is not entered promptly.

**Setup** The system will boot, but access to Setup will be denied if the correct password is not entered promptly.

- The choice: System or Setup.

---

Note: To disabled security, select PASSWORD SETTING at Main Menu, and then you will be asked to enter password. Do not type anything and just press < Enter > ; it will disable security. Once the security is disabled, the system will boot, and you can enter Setup freely.

#### **OS Select For DRAM > 64MB**

Selects the operating system that is running with greater than 64MB of RAM in the system.

- The choice: Non-OS2 or OS2.

#### **Video BIOS Shadow**

Determines whether video BIOS will be copied to RAM. However, it is optional depending on chipset design. Video Shadow will increase the video speed.

- The choice: Enabled or Disabled.

#### **C8000-CBFFF Shadow/DC000-DFFFF Shadow**

These categories determine whether option ROMs will be Chipset Features Setup Auto Configuration copied to RAM. An example of such option ROM would be the support to on-board SCSI.

- The choice: Enabled or Disabled.

---

## ➤ **Advanced Chipset Features**

This section allows you to configure the system based on the specific features of the installed chipset. This chipset manages bus speeds and access to system memory resources, such as DRAM and the external cache. It also coordinates communications between the conventional ISA bus and the PCI bus. It states that these items should never need to be altered.

The default settings have been chosen because they provide the best operating conditions for your system. If you discovered that data was being lost while using your system, you might consider making any changes.

CMOS Setup Utility - Copyright (C) 1984-2000 Award Software Advanced Chipset Features		
Bank 0/1 DRAM Timing	SDRAM 8/10ns	Item Help
Bank 2/3 DRAM Timing	SDRAM 8/10ns	
Bank 4/5 DRAM Timing	SDRAM 8/10ns	Menu Level ▶
SDRAM Cycle Length	3	
DRAM Clock	Host CLK	
Memory Hole	Disabled	
P2C/C2P Concurrency	Enabled	
Fast R-W Turn Around	Disabled	
System BIOS Cacheable	Disabled	
Video RAM Cacheable	Disabled	
Frame Buffer Size	8M	
AGP Aperture Size	64M	
AGP-4X Mode	Enabled	
AGP Driving Control	Manual	
AGP Driving Value	DA	
OnChip USB	Enabled	
USB Keyboard Support	Disabled	
USB Mouse Support	Disabled	
OnChip Sound	Auto	
OnChip Modem	Auto	
CPU to PCI Write Buffer	Enabled	
PCI Dynamic Bursting	Enabled	
PCI Master 0 WS Write	Enabled	
PCI Delay Transaction	Disabled	
PCI#2 Access #1 Retry	Enabled	
AGP Master 1 WS Write	Disabled	
AGP Master 1 WS Read	Disabled	

↑↓←→:Move Enter:Select +/-/PU/PD:Value F10:Save ESC:Exit F1:General Help  
F5:Previous Values F6:Fail-Safe Defaults F7:Optimized Defaults

### **Bank x/x DRAM Timing**

This item allows you to select the value in this field, depending on whether the board has paged DRAMs or EDO (extended data output) DRAMs.

- The Choice: SDRAM 8/10ns, Normal, Medium, Fast, or Turbo.

### **SDRAM Cycle Length**

When synchronous DRAM is installed, the number of clock cycles of CAS latency depends on the DRAM timing. Do not reset this field from the default value specified by the system designer.

- The Choice: 2 or 3

---

### **DRAM Clock**

This item allows you to control the DRAM speed.

- The Choice: Host CLK, HCLK + 33M, or HCLK-33M.

### **Memory Hole**

In order to improve performance, some space in memory can be reserved for ISA cards.

- The Choice: Disabled or 15M-16M.

### **P2C/C2P Concurrency**

This item allows you to enable/disable the PCI to CPU and CPU to PCI concurrently.

- The Choice: Enabled or Disabled.

### **Fast R-W Turn Around**

This item controls the DRAM Timing. It allows you to enable/disable the fast read/write turn-around.

- The Choice: Enabled or Disabled.

### **System BIOS Cacheable**

Selecting Enabled allows caching of the system BIOS ROM at F0000h-FFFFFh, resulting in better system performance. However, if any program is written to this memory area, a system error may result.

- The choice: Enabled or Disabled.

### **Video RAM Cacheable**

Selecting Enabled allows caching of the video RAM, resulting in better system performance. However, if any program is written to this memory area, a system error may result.

- The Choice: Enabled or Disabled.

### **Frame Buffer Size**

This item allows you to control the VGA frame buffer size.

- The choice: 4M, 8M, 16M, or 32M.

### **AGP Aperture Size (MB)**

Select the size of Accelerated Graphics Port (AGP) aperture. The aperture is a portion of the PCI memory address range dedicated to graphics memory address space. Host cycles that hit the aperture range are forwarded to the AGP without any translation.

- The Choice: 4M, 8M, 16M, 32M, 64M, or 128M.

---

### **AGP-4X Mode**

This item allows you to enable/disable the AGP-4X Mode.

- The Choice: Enabled or Disabled.

### **AGP Driving Control**

This item enables the system to automatically select its output buffer drive strength or make it manually selectable by an end user.

- The Choice: Auto or Manual.

### **AGP Driving Value**

This item enables an end user to manually select the AGP output buffer drive strength.

- The Choice: 0000 ~ 00FF.

### **On Chip USB**

This should be enabled if your system has a USB installed on the system board and you want to use it. Even when on chip USB so equipped, if you add a higher performance controller, you will need to disable this feature.

- The Choice: Enabled or Disabled.

### **USB Keyboard Support**

Select Enabled if your system contains a Universal Serial Bus (USB) controller and you have a USB keyboard.

- The Choice: Enabled or Disabled.

### **USB Mouse Support**

Select Enabled if your system contains a Universal Serial Bus (USB) controller and you have a USB Mouse.

- The Choice: Enabled or Disabled.

### **On Chip Sound**

This item allows you to control the onboard AC 97 audio.

- The Choice: Auto or Disabled.

### **On Chip Modem**

This item allows you to control the onboard MC 97 Modem.

- The Choice: Auto or Disabled.

---

### **CPU to PCI Write Buffer**

When this field is Enabled, the writing from CPU to PCI bus is buffered, to compensate for the speed differences between the CPU and the PCI bus. When Disabled, the writing is not buffered and the CPU must wait until the write is complete before starting another write cycle.

- The Choice: Enabled or Disabled.

### **PCI Dynamic Bursting**

This item allows you to enable/disable the PCI dynamic bursting function.

- The Choice: Enabled or Disabled.

### **PCI Master 0 WS Write**

When this item enabled, writing to the PCI bus is executed with zero wait state.

- The Choice: Enabled or Disabled.

### **PCI Delay Transaction**

The chipset has an embedded 32-bit posted write buffer to support delay transactions cycles. Select Enabled to support compliance with PCI specification version 2.1.

- The Choice: Enabled or Disabled.

### **PCI #2 Access #1 Retry**

When this item disabled, PCI#2 will not be disconnected until access finishes (default); On the contrary, PCI#2 will be disconnected if max entries are attempted without success.

- The Choice: Enabled or Disabled.

### **AGP Master 1 WS Write**

When this item enabled, writing to the AGP(Accelerated Graphics Port) is executed with one wait state.

- The Choice: Enabled or Disabled.

### **AGP Master 1 WS Read**

When this item enabled, reading from the AGP (Accelerated Graphics Port) is executed with one wait state.

- The Choice: Enabled or Disabled.

## ☛ Integrated Peripherals

CMOS Setup Utility - Copyright (C) 1984-2000 Award Software Integrated Peripherals		
OnChip IDE Channel0	Enabled	Item Help
OnChip IDE Channel1	Enabled	
IDE Prefetch Mode	Enabled	Menu Level ▶
Primary Master PIO	Auto	
Primary Slave PIO	Auto	
Secondary Master PIO	Auto	
Secondary Slave PIO	Auto	
Primary Master UDMA	Auto	
Primary Slave UDMA	Auto	
Secondary Master UDMA	Auto	
Secondary Slave UDMA	Auto	
Init Display First	PCI Slot	
IDE HDD Block Mode	Enabled	
Onboard FDD Controller	Enabled	
Onboard Serial Port 1	Auto	
Onboard Serial Port 2	Auto	
UART 2 Mode	HPSIR	
IR Function Duplex	Half	
TX,RX inverting enable	No, Yes	
Onboard Parallel Port	378/IRQ7	
Onboard Parallel Mode	Normal	
ECP Mode Use DMA	3	
Parallel Port EPP Type	EPP1.9	
Onboard Legacy Audio	Enabled	
Sound Blaster	Disabled	
SB I/O Base Address	220H	
SB IRQ Select	IRQ 5	
SB DMA Select	DMA 1	
MPU-401	Enabled	
MPU-401 I/O Address	330-333H	
Game Port (200-207H)	Enabled	

↑↓:Move Enter:Select +/-/PU/PD:Value F10:Save ESC:Exit F1:General Help  
F5:Previous Values F6:Fail-Safe Defaults F7:Optimized Defaults

### OnChip IDE Channel0

The chipset contains a PCI IDE interface with support to two IDE channels. Select Enabled to activate the primary IDE interface; select Disabled to deactivate this interface

- The choice: Enabled or Disabled.

### OnChip IDE Channel1

The chipset contains a PCI IDE interface with support to two IDE channels. Select Enabled to activate the secondary IDE interface; select Disabled to deactivate this interface

- The choice: Enabled or Disabled.

### IDE Prefetch Mode

The onboard IDE drive interfaces support IDE prefetching for faster drive access. If you install a primary and/or secondary add-on IDE interface, set this field to Disabled if the interface does not support prefetching.

- The choice: Enabled or Disabled.

---

### **Primary/Secondary Master/Slave PIO**

The four IDE PIO (Programmed Input/Output) fields let you set a PIO mode (0-4) for each of the four IDE devices that the onboard IDE interface supports. Modes 0 through 4 provide successively increased performance. In Auto mode, the system automatically determines the best mode for each device.

- The choice: Auto, Mode 0, Mode 1, Mode 2, Mode 3, or Mode 4.

### **Primary/Secondary Master/Slave UDMA**

Ultra DMA/66 implementation is possible only if your IDE hard drive supports it and the operating environment includes a DMA driver (Windows 95 OSR2 or a third-party IDE bus master driver). If both of your hard drive and your system software support Ultra DMA/66, select Auto to enable BIOS support.

- The choice: Auto or Disabled.

### **Init Display First**

This item allows you to decide to activate PCI Slot or on-chip VGA first.

- The choice: PCI Slot or AGP.

### **IDE HDD Block Mode**

Block mode is also called block transfer, multiple commands, or multiple sector read/write. If your IDE hard drive supports block mode (most new drives do), select Enabled for automatic detection of the optimal number of block read/write per sector the drive can support.

- The choice: Enabled or Disabled

### **Onboard FDC Controller**

Select Enabled if your system has a floppy disk controller (FDC) installed on the system board and you want to use it. If you install add-on FDC or the system has no floppy drive, select Disabled in this field.

- The choice: Enabled or Disabled.

### **Onboard Serial Port1/Port2**

Select an address and corresponding interrupt for the first and second serial ports.

- The choice: 3E8/IRQ4, 2E8/IRQ3, 3F8/IRQ4, 2F8/IRQ3, Auto, or Disabled.

---

### **UART 2 Mode**

This item allows you to select which mode for the Onboard Serial Port 2.

- The choice: Standard, HPSIR, or ASKIR

### **IR Function Duplex**

This item allows you to select the IR half/full duplex function.

- The choice: Half, or Full.

### **TX, RX inverting enable**

This item allows you to enable the TX, RX inverting which depends on different H/W requirement. This field is not recommended to change its default setting for avoiding any error in your system

- The choice: No, No, No,Yes, Yes, No, or Yes, Yes.

### **Onboard Parallel Port**

This item allows you to determine onboard parallel port controller I/O address setting.

- The choice:: 378/IRQ7, 278/IRQ5, 3BC/IRQ7, or Disabled.

### **Onboard Parallel Mode**

Select an operating mode for the onboard parallel (printer) port. Select Normal, Compatible, or SPP unless you are certain your hardware and software both support one of the other available modes.

- The choice: Normal, EPP, ECP, or ECP/EPP.

### **ECP Mode Use DMA**

Select a DMA channel for the parallel port for use during ECP mode.

- The choice: 1 or 3.

### **Parallel Port EPP Type**

Select a DMA channel for the parallel port for use during ECP mode.

- The choice: EPP1.7 or EPP1.9.

### **Onboard Legacy Audio**

This field controls the onboard legacy audio.

- The choice: Enabled or Disabled.

### **Sound Blaster**

This item enables/disables the onboard Sound Blaster.

- The choice: Enabled or Disabled.

---

**SB I/O Base Address**

This item selects the Sound Blaster I/O Base Address.

- The choice: 220H, 240H, 260H, or 280H.

**SB IRQ Select**

This item selects the Sound Blaster IRQ.

- The choice: IRQ5, IRQ7, IRQ 9, or IRQ10.

**SB DMA Select**

This item selects the Sound Blaster DMA.

- The choice: DMA0, DMA1, DMA2, or DMA3.

**MPU-401**

This item enables/disables on-board MPU-401.

- The choice: Enabled or Disabled.

**MPU-401 I/O Address**

This item selects MPU-401 I/O Address.

- The choice: 300-303H, 310-313H, 320-323H, or 330-333H.

---

## ➤ Power Management Setup

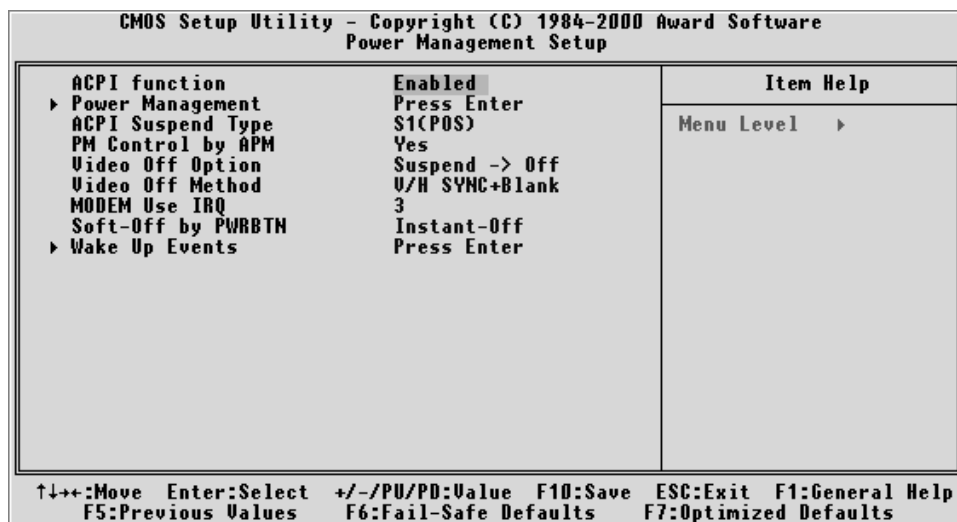

The Power Management Setup allows you to configure your system to most effectively saving energy while operating in a manner consistent with your own style of computer use.

### ACPI Function

This item allows you to enable/disable the Advanced Configuration and Power Management (ACPI)

➤ The choice: Enabled or Disabled.

### Power Management

This category allows you to select the type (or degree) of power saving and is directly related to the following modes:

1. HDD Power Down
2. Doze Mode
3. Suspend Mode

There are four selections for Power Management, three of which have fixed mode settings.

#### Min. Power Saving

Minimum power management. Doze Mode = 1 hr. Standby Mode = 1 hr., Suspend Mode = 1 hr., and HDD Power Down = 15 min.

#### Max. Power Saving

Maximum power management -- ONLY AVAILABLE FOR SL CPU'S. Doze Mode = 1 min., Standby Mode = 1 min., Suspend Mode = 1 min., and HDD Power Down = 1 min.

---

**User Defined** Allows you to set each mode individually. When this item not disabled, each of the ranges are from 1 min. to 1 hr. except for HDD Power Down which ranges from 1 min. to 15 min. and disable.

- The choice: User Define, Min Saving, or Max Saving.

### **ACPI Suspend Type**

This item allows you to select sleep state when suspend.

- The choice: S1(POS), or S3(STR).

### **PM Control by APM**

When this item enabled, an Advanced Power Management device will be activated to enhance the Max. Power Saving mode and stop the CPU internal clock. If Advance Power Management (APM) is installed on your system, selecting Yes gives better power saving.

If the Max. Power Saving is not enabled, this will be preset to No.

- The choice: Yes or No.

### **Video Off Option**

When enabled, this feature allows the VGA adapter to operate in a power saving mode.

**Always On** Monitor will remain on during power saving mode.

**Suspend --> Off** Monitor is blanked when the system enters the Suspend mode.

**All Modes --> Off** Monitor is blanked when the system enters any power saving mode.

- The choice: Always On, Suspend -> off, or All Modes -> off.

### **Video Off Method**

This determines the manner in which the monitor is blanked.

**V/H SYNC + Blank** This selection will cause the system to turn off the vertical and horizontal synchronization ports and write blanks to the video buffer.

**Blank Screen** This option only writes blanks to the video buffer.

**DPMS Support** Initial display power management signaling.

- The choice: V/H SYNC + Blank, Blank Screen, or DPMS Support.

---

### **MODEM Use IRQ**

This determines the IRQ which the MODEM can use.

- The choice: 3, 4, 5, 7, 9, 10, 11, or N/A.

### **Soft-Off by PWRBTN**

Pressing the power button for more than 4 seconds forces the system to enter the Soft-Off state when the system has "hung."

- The choice: Instant-Off or Delay 4 Sec.
- The choice: 1Min, 2Min, 4Min, 8Min, 12Min, 20Min, 30Min, 40Min, 1Hour, or Disabled.

### **Wake Up Events**

This item enables a user to select wake up events. Press "Enter" to choose whether a specified event can wake up a system from suspend mode or not ; events include "VGA", "LPT & COM", "HDD & FDD", "PCI Mster", "Modem Ring Resume", "RTC Alarm Resume", "Primary INTR", and "IRQs Activity Monitoring".

## ***PM Events***

PM events are I/O events whose occurrence can prevent the system from entering a power saving mode or can awaken the system from such a mode. In effect, the system remains alert for anything which occurs in a device which is configured as On, even when the system is in a power down mode.

### **VGA**

When this item enabled, you can set VGA to awaken the system.

- The choice: OFF or ON

### **LPT & COM**

When LPT & COM stays On, any activity from one of the listed system peripheral devices or IRQs wakes up the system.

- The choice: NONE, LPT, COM, or LPT/COM

### **HDD & FDD**

When HDD & FDD stays On, any activity from one of the listed system peripheral devices wakes up the system.

- The choice: OFF or ON

### **PCI Master**

When PCI Master stays On, any activity from one of the listed system peripheral devices wakes up the system.

- The choice: OFF, or ON

---

### **Power-On by PCI Card**

This item enables/disables the power on function of PCI Card.

- The choice: Disabled or Enabled.

### **Wake Up On LAN/Ring**

This item determines the system will resume by activity of LAN/Ring. If enabled this feature enabled, system will power on itself from power-off mode when the activity of LAN/Ring

- The choice: Disabled or Enabled.

### **RTC Alarm Resume**

When this item enabled, your can set the date and time at which the RTC (real-time clock) alarm awakens the system from Suspend mode.

- The choice: Disabled or Enabled.

### **Data (of Month)**

This item selects the alarm date.

- Key in a DEC number:Min=0, Max= 31.

### **Resume Time (hh:mm:ss)**

This item selects the alarm Time.

- Key in a DEC number:Min=0, Max= 23.

### **Primary INTR**

Press Enter to enable/disable the wake up ability of a specified IRQ.

- The choice: OFF, or ON.

In the following is a list of IRQ's, Interrupt ReQuests, which can be exempted much as the COM ports and LPT ports above can. When an I/O device wants to gain the attention of the operating system, it signals this by causing an IRQ to occur. When the operating system is ready to respond to the request, it interrupts itself and performs the service.

When On mode exist, activity will neither prevent the system from going into a power management mode nor awaken it.

- \* IRQ3 (COM 2)
- \* IRQ4 (COM 1)
- \* IRQ5 (LPT 2)
- \* IRQ6 (Floppy Disk)
- \* IRQ7 (LPT 1)
- \* IRQ8 (RTC Alarm)
- \* IRQ9 (IRQ2 Redir)

- 
- \* IRQ10 (Reserved)
  - \* IRQ11 (Reserved)
  - \* IRQ12 ( PS / 2 Mouse )
  - \* IRQ13 (Coprocessor)
  - \* IRQ14 (Hard Disk)
  - \* IRQ15 (Reserved).

### **PM Timers**

The following four modes are Green PC power saving functions which are configured by user only when User Defined Power Management has been selected. See above for available selections.

#### **HDD Power Down**

When this item enabled and after the set up time of system inactivity, the hard disk drive will be powered down while all other devices remain active.

- The choice: Disabled or 1 Min ~ 15 Min.

#### **Doze Mode**

When this item enabled and after the set up time of system inactivity, the CPU clock will run at a lower speed while all other devices still operate at full speed.

- The choice: Disabled, 1 Min, 2 Min, 4 Min, 6 Min, 8 Min, 10 Min, 20 Min, 30 Min, 40 Min, or 1 Hour.

#### **Suspend Mode**

When this item enabled and after the set up time of system inactivity, all devices except the CPU will be shut off.

- The choice: Disabled, 1 Min, 2 Min, 4 Min, 6 Min, 8 Min, 10 Min, 20 Min, 30 Min, 40 Min, or 1 Hour.

---

## ➤ PnP/PCI Configuration

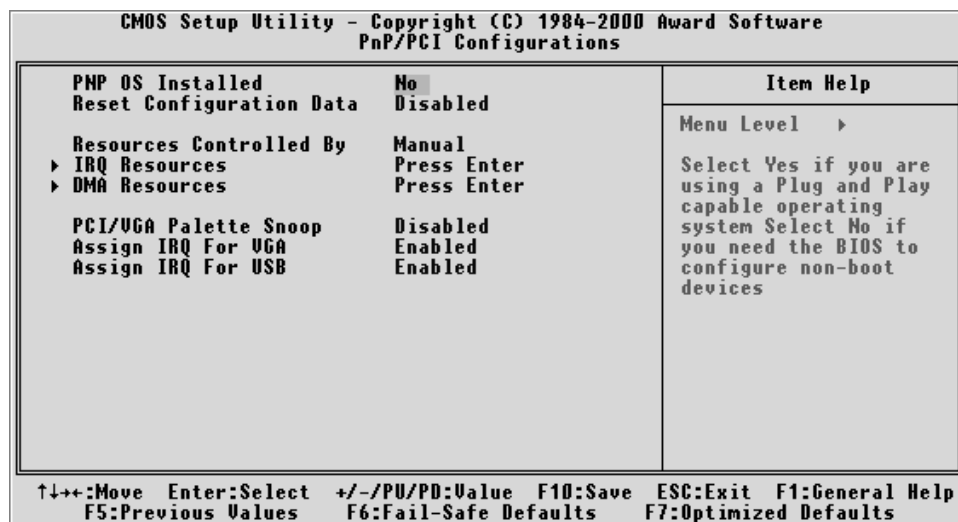

This section describes the configuration of PCI bus system. PCI or Personal Computer Interconnection is a system which allows I/O devices to operate at the speed CPU itself keeps when CPU communicating with its own special components.

This section covers some very technical items, and it is strongly recommended that only experienced users should make any changes to the default settings.

### PNP OS Installed

This item allows you to determine PnP OS is installed or not.

- The choice: Yes or No.

### Reset Configuration Data

Normally, you leave this field Disabled. Select Enabled to reset Extended System Configuration Data (ESCD) when you exit from Setup if you have installed a new device or software and the system reconfiguration has caused such a serious conflict that the operating system can not boot.

- The choice: Enabled or Disabled .

### Resource controlled By

The Award Plug-and-Play BIOS has the capacity to automatically configure all of the boot and Plug-and-Play compatible devices. However, this capability means absolutely nothing unless you are using a Plug-and-Play operating system such as Windows 95.

---

If you set this field to "manual" , choose specific resources by going into each of the sub-menu that follows this field (a sub-menu is preceded by a "> ").

- The choice: Auto(ESCD) or Manual.

### **IRQ/DMA Resources**

When resources are controlled manually, assign each system interrupt a type, depending on the type of device using the interrupt.

#### **IRQ3/4/5/7/9/10/11/12/14/15 assigned**

This item allows you to determine the IRQ assigned to the ISA bus and is not available to any PCI slot. Legacy ISA for devices is compliant with the original PC AT bus specification; PCI/ISA PnP for devices is compliant with the Plug-and-Play standard whether designed for PCI or ISA bus architecture.

- The choice: Legacy ISA or PCI/ISA PnP.

#### **DMA 0/1/3/5/6/7 assigned**

When resources are controlled manually, assign each system DMA channel as one of the following types, depending on the type of device using the interrupt:

Legacy ISA Devices compliant with the original PC AT bus specification, requiring a specific interrupt ( such as IRQ4 for serial port 1). PCI/ISA PnP Devices compliant with the Plug-and-Play standard, whether designed for PCI or ISA bus architecture.

- The choice: Legacy ISA or PCI/ISA PnP.

### **PCI/VGA Palette Snoop**

Leave this field Disabled.

- The choice: Enabled or Disabled.

### **Assign IRQ For VGA**

This item allows the user to set VGA IRQ Routing table Enabled or Disabled.

- The choice: Enabled or Disabled.

### **Assign IRQ For USB**

This item allows the user the option to assign an IRQ to on-board USB controller.

Since the on-board controller is always enabled, if no IRQ is assigned to it, there will be a question mark report on the sytem device under Windows95/98.

- The choice: Enabled or Disabled.

---

➤ **PC Health Status**

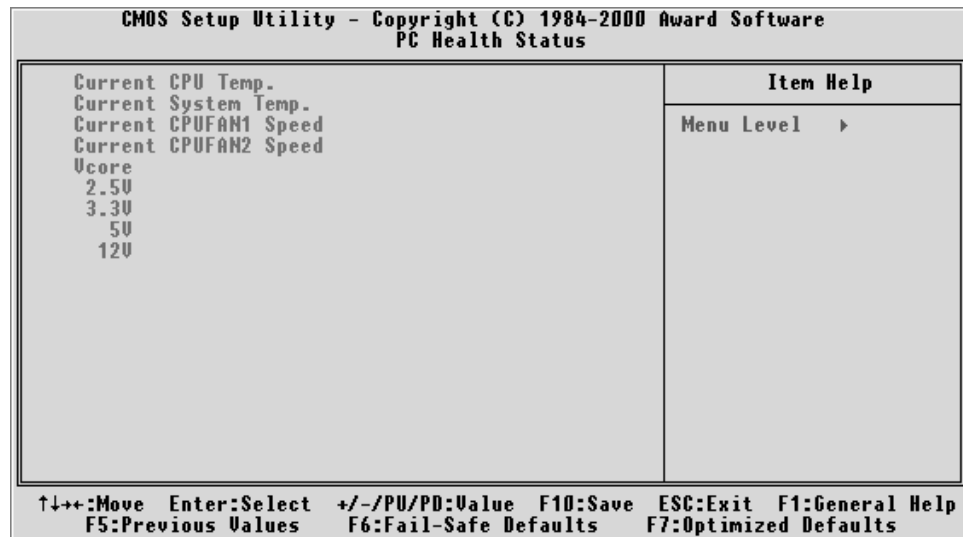

**Current CPU Temperature (optional)**

Since the mainboard supports CPU temperature monitoring and over-heat alert. This item indicates the current Processor temperature.

**Current System Temp (optional)**

Since the mainboard supports System temperature monitoring and overheat alert. This item indicates the current main board temperature.

**Current CPUFAN1/2 Speed (optional)**

The mainboard can detect two fans rotation speed for CPU cooler and system.

**Vcore, 2.5V, 3.3V, 5V, 12V (optional)**

The mainboard supports CPU and mainboard voltages monitoring. The onboard hardware monitor is able to detect the CPU voltage (Vcore) and the voltage output from power supply.

---

## ➤ Frequency/Voltage Control

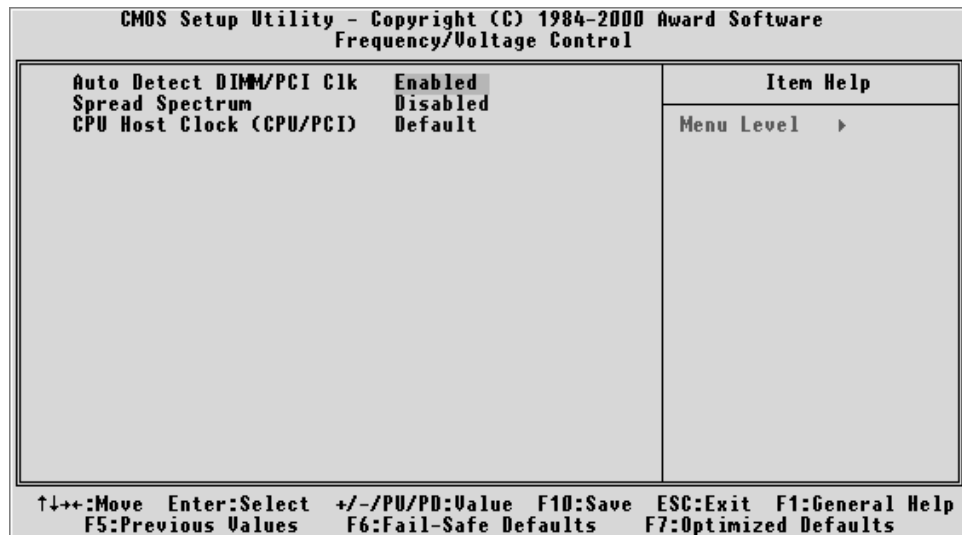

### Auto Detect DIMM/PCI Clk

This item allows you to enable/disable auto detection DIMM/PCI Clock.

- The choice: Enabled or Disabled.

### Spread Spectrum

This item allows you to enable/disable the spread spectrum modulation.

- The choice: Disabled, 0.25%, or 0.50%.

### CPU Host Clock (CPU/PCI)

This item allows the user to adjust CPU Host Bus Clock from BIOS when JP1 is set to Auto.

This item will not show up when JP1 is set to Manual.

- The choice: Default, 66/33 MHz, 75/37 MHz, 83/41 MHz, 100/33 MHz, 103/34 MHz, 112/37 MHz, 124/41 MHz, 133/44 MHz, 124/31 MHz, 133/33 MHz, 140/35 MHz, or 150/37 MHz.

---

☛ **Load Fail-Safe Defaults**

When you press < Enter > on this item, you will get a confirmation dialog box with a message similar to:

Load Fail-Safe Defaults (Y/N) ? N

Pressing 'Y' loads the BIOS default values for the most stable, minimal performance system operations.

☛ **Load Optimized Defaults**

When you press < Enter > on this item, you will get a confirmation dialog box with a message similar to:

Load Optimized Defaults (Y/N) ? N

Pressing 'Y' loads the default values that are factory-set for optimal performance system operation.

---

## ➤ Supervisor/User Password Setting

You can set either supervisor or user password, or both of them. The differences between them are:

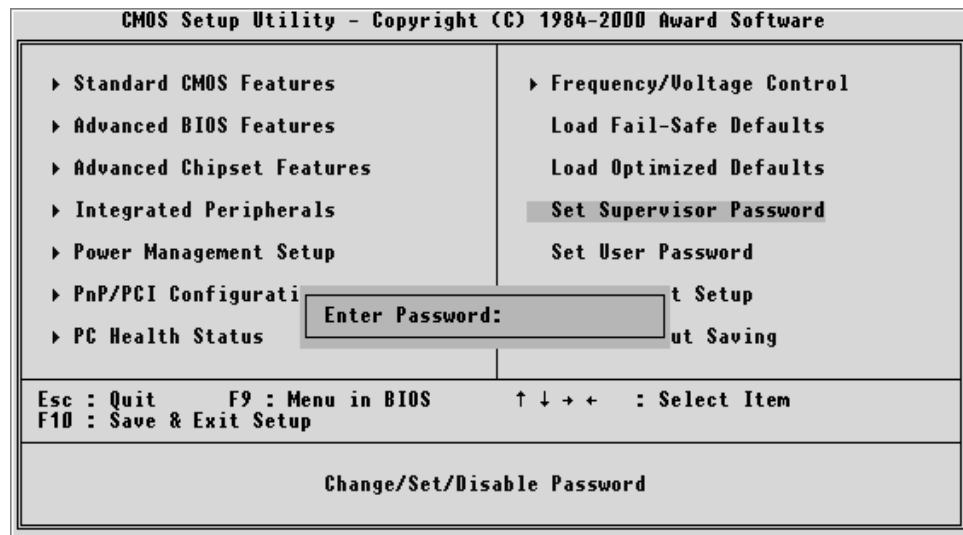

### Supervisor Password and User Password

The options on the Password screen menu make it possible to restrict access to the Setup program by enabling you to set passwords for two different access modes: Supervisor mode and User mode.

In general, Supervisor mode has full access to the Setup options, whereas User mode has restricted access to the options. By setting separate Supervisor and User password, a system supervisor can limit who can change critical Setup values.

### Enter Password

Type the password up to eight characters, and press < Enter > . The password typed now will clear any previously entered password from CMOS memory. You will be asked to confirm the password. Type the password again and press < Enter > . You may also press < Esc > to abort the selection and not enter a password.

To disable password, just press < Enter > when you are prompted to enter password. A message will confirm the password being disabled. Once the password is disabled, the system will boot and you can enter Setup freely.

---

### **Password Disable**

If you select System at Security Option of BIOS Features Setup Menu, you will be prompted in entering the password whenever the system is rebooted or you try to enter Setup. If you select Setup at Security Option of BIOS Features Setup Menu, you will be prompted only when you try to enter Setup.

**Warning:** Retain a record of your password in a safe place. If you forget the password, the only way to access the system is to clear CMOS, please refer to "Clear CMOS" on page 30.

---

☛ **Save & Exit Setup**

Pressing < Enter > on this item asks for confirmation:

Save to CMOS and EXIT (Y/N)? Y

Pressing "Y" stores the selections made in the menus of CMOS - a special section of memory that stays on after you turn your system off. The next time you boot your computer, the BIOS configures your system according to the Setup selections stored in CMOS. After saving the values the system is restarted again.

☛ **Exit Without Saving**

Pressing < Enter > on this item asks for confirmation:

Quit without saving (Y/N)? Y

This allows you to exit from Setup without storing in CMOS any change. The previous selections remain in effect. This exits from the Setup utility and restarts your computer.