

Advanced Pentium II Motherboard

User's Manual

QS440BX

USER'S MANUAL

Copyright © 1998 GVC CORPORATION. ALL RIGHTS RESERVED.

NOTICE

Rights:

No part of this manual, including but not limited to the products and software described in it, may be reproduced, transmitted, transcribed, stored in a retrieval system, or translated in any form or by any means without the expressed written permission of GVC “Corporation or BCM Advanced Research, Inc.

Products and corporate names appearing in this manual may or may not be registered trademarks or copyrights of their respective companies and are used only for identification or explanation purposes without intent to infringe.

- Intel, MMX and Pentium are registered trademarks of Intel Corporation.
- IBM and OS/2 are registered trademarks of International Business Machines.
- AWARD is a registered trademark of American Megatrends Inc.
- Winbond is a registered trademark of Winbond Electronics Inc.

Responsibility:

This manual is provided “As is” with no warranties of any kind, either expressed or implied, including, but not limited to the implied warranties or conditions of this product’s fitness for any particular purpose. In no event shall we be liable for any loss of profits, loss of business, loss of data, interruption of business, or indirect, special, incidental, or consequential damages of any kind, even the possibility of such damages arising from any defect or error in this manual or product. We reserve the right to modify and update the user manual without prior notice.

COMPLIANCE & CERTIFICATE

ISO 9001 Certificate:



This device was produced in our plant with advanced quality system certified by DNV QA Ltd. in according to ISO 9001. This Certificate is valid for:
DESIGN & MANUFACTURE OF MOTHER BOARDS AND PERSONAL COMPUTERS.

CE Declaration:



CE marking is a visible declaration by the manufacturer or his authorized representatives that the electrical equipment to which it relates satisfies all the provisions of the 1994 Regulations.

FCC Compliance:



FCC stands for **Federal Communications Commission**. This product complies with FCC Rules Part 15 and has been tested, and complied with the EMI rules by a certified body. In normal operation, there shall be no harmful interference caused by this device nor shall this device accept any interference received, including interference that may cause undesired operation of this product.

Microsoft Windows Compliance:

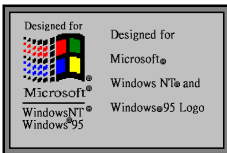

Microsoft, Windows NT, Windows, and the Windows Logo are registered trademarks of Microsoft Corporation.

EASY INSTALLATION



The following “Easy Installation” steps are for users accustomed to the assembly of a computer system. For those individuals requiring more specific information please refer to the more detailed descriptions located within the latter chapters of this manual. Note: You must keep your power cable unplugged until the following installation steps are completed.

Getting Start:

Touch a grounded metal surface to release static electricity stored in your body before unpacking your motherboard. For details please refer to **Precaution** section in **Chapter 3**.

Install the CPU by correctly aligning the CPU with the Slot 1 as noted in the motherboard diagram. Once aligned, press down on the CPU gently but firmly. Next, install either the 3.3 volt unbuffered EDO or SDRAM into the 168 pin DIMMs. See **Sec. 3.2 & Sec. 3.3**.

After completing the above steps, install any expansion cards into the appropriate PCI, ISA or AGP slots and screw them tight to the chassis. See **Sec. 3.4**.

Plug in all cables included in the package except for the power cord. Please see **Sec. 3.5**.

Please recheck all steps to ensure no mistakes have been made and then plug in the power cord and turn on the power to enter the BIOS setup, **Chapter 4**.

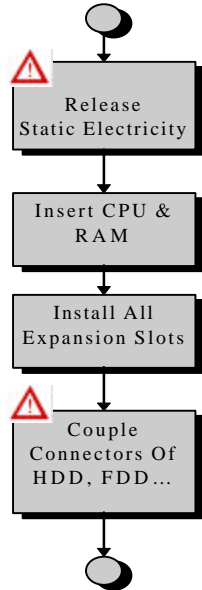

CONTENTS

1. INTRODUCTION

How To Use This Manual	Page7
Check Your Device Items	Page7

2. FEATURES

Photo Of The Motherboard	Page8
Features Of The Motherboard	Page9

3. INSTALLATION

Motherboard Layout & Main Parts	Page11
Significant Parts List	Page12
Precaution Before Start	Page13

3.1 Slots And Connectors	Page14
--------------------------	--------

3.2 CPU	Page15
---------	--------

3.3 System Memory (DRAM)	Page18
----------------------------	--------

 3.3.1 DIMM (Dual Inline Memory Module)

 3.3.2 Installation Procedure

 3.3.3 DIMM Combinations

3.4 Expansion Slots	Page20
---------------------	--------

3.5 Connectors	Page21
----------------	--------

 3.5.1 Primary IDE Connector

 3.5.2 Secondary IDE Connector

 3.5.3 Floppy Drive Connector

CONTENTS

- 3.5.1 Power Input Connector
- 3.5.2 Front Panel Connectors
- 3.5.3 Back Panel Connectors
- 3.5.4 Additional Connectors

Ready To Turn On Power **Page30**

4. BIOS SETUP

- 4.1 How To Enter BIOS Setup** **Page31**
 - 4.1.1 Setup Keys
 - 4.1.2 Getting Help
 - 4.1.3 In Case of Problems

- 4.2 Main Setup Menu** **Page33**
- 4.3 Standard CMOS Setup Menu** **Page34**
- 4.4 BIOS Features Setup Menu** **Page39**
- 4.5 Chipset Features Setup Menu** **Page42**
- 4.6 Power Management Setup Menu** **Page44**
- 4.7 PCI Configuration Setup Menu** **Page48**
- 4.8 Integrated Peripherals Menu** **Page50**
- 4.9 IDE Auto Detection** **Page52**
- 4.10 Password Setting** **Page52**

1. INTRODUCTION



How To Use This Manual

This manual provides information necessary for Original Equipment Manufactures (OEMs) and home users to build a PC-AT compatible system using the Pentium II AGP/PCI motherboard.

Just follow the installation procedure

presented on the **EASY INSTALLATION Page** and refer to the section number following each step if you require more detailed instructions.

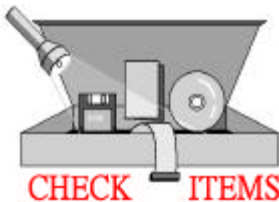

Check Your Device Items

The standard package should contain following items marked with a “✓”, If you find any these items missing or damaged. Please contact your retailer.

- The QS440BX motherboard
- Retention Mechanism
- 1 IDE ribbon cable
- 1 floppy ribbon cable
- 1 CD-ROM Diskette with system Hardware Monitor and PIIX4 Bus Master Driver inside or 1 Floppy Diskette with only PIIX4 bus Master Driver.
- Infrared (IrDA) module with ribbon cable (optional)
- Pentium II Retention Mechanism (optional)

2. FEATURES

Photo Of The Motherboard

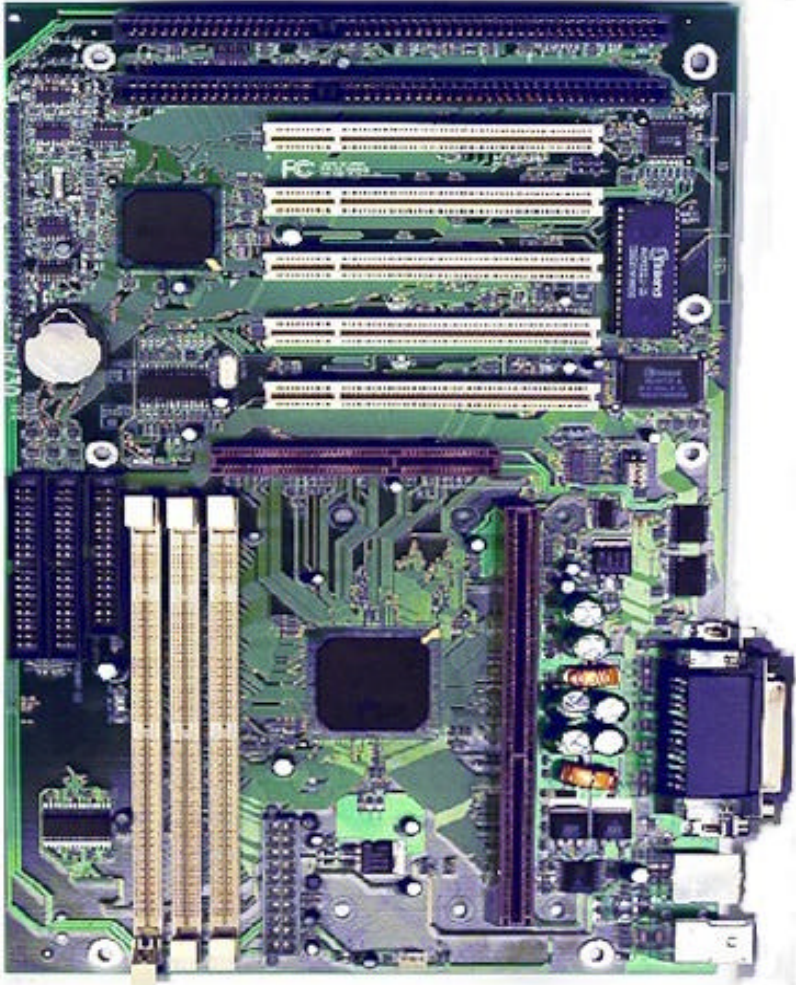

2. FEATURES



Features Of The Motherboard

The QS440BX motherboard integrates the Pentium® II microprocessor, memory, I/O and AGP (Accelerated Graphics Port) and is designed to fit into a standard ATX form factor chassis. Page 12 illustrates the Layout for the QS440BX motherboard. Below lists the key features provided by this motherboard:

Processor (+Cache)

- Single slot-1 for Pentium® II processor
- Supports Pentium II processor speeds (233-450MHz)
- 512KB second-level cache integrated into the Single Edge Pentium® II Contact cartridge

Chipset

- 82440BX AGP/PCI/ISA Chipset.

System Memory

- Three 168-pin DIMM sockets
- Minimum 8MB up to maximum 384 MB of unbuffered SDRAM or EDO RAM
- ECC (Error Checking & Correction) or non-ECC memory support

Graphics Support

- Supports AGP (Accelerated Graphics Port) for increased performance of Graphic Displays, special 3D operations in multimedia, and higher speed to satisfy the users optical vision.
- AGP Interface supports data transfers at 66 MHz (1x) or 133 MHz (2X) with full side-band signals.

PCI Bus Master IDE Controller

- Integrated PCI Bus Master IDE Controller Chip with Ultra-DMA33 capabilities. Up to four IDE devices can be supported using the two onboard IDE connectors. Also supported is PIO Modes 3&4, Bus Master IDE DMA Mode 2 and Enhanced IDE devices such as Tape Backup machines and CD-ROMs. Either the 5.25-inch or 3.5 inch (1.44MB or 2.88MB) floppy drives can be used without requiring an external card. Additionally, Floppy 3 mode (Japanese standard 3.5 inch disk drive, 1.2MB) and LS-120 floppy disk drives (3.5 inch disk drive: 120MB, 1.44MB, 720K) are also supported.

2. FEATURES

Features Of The Motherboard

Integrated I/O

- Winbond 977, supporting two-async serial ports with high speed 16C550 and 16-byte FIFO. One Parallel port supporting EPP, ECP and Bi-directional modes. PS/2 keyboard port and mouse port.
- (Optional) Infrared port module (IrDA) for wireless interface.

Hardware Monitoring

- (Optional) Onboard LM78 / LM75 chip to monitor variable voltages used in system CPU fan speed, and temperature.

External Communication Ports

- Universal Serial Bus (USB) integrated with Core Logic.

System BIOS

- AWARD BIOS based on 1MB Flash ROM. Enable IDE Auto-configuring, support ISA Plug & play, PC-97, Multi-Boot and PCI Add-In card auto-configuring.
- Also it supports DMI, which allows hardware to communicate within a standard protocol creating a higher level of compatibility. (Requires DMI-enabled component.)

Green Features

- Power Management: APM 1.2, Meets EPA Mode 2.0.
- Additionally, with support for ACPI (Advanced Configuration and Power Interface) feature, your system will become more wise in management of power.

Additional features

- Wake-On-LAN header
- Smart soft power control
- SB-LINK header to support legacy Sound Blaster compatible Audio to the PCI bus.

Expansion Slots

- Five PCI, Two ISA bus slots (one slot is shared) and One AGP slot for your variable usage.

Mechanical

- This motherboard complies with the ATX Form Factor specifications and is a four layers with dimensions of 7.5" x 12.0".

3. INSTALLATION

Motherboard Layout & Main Parts

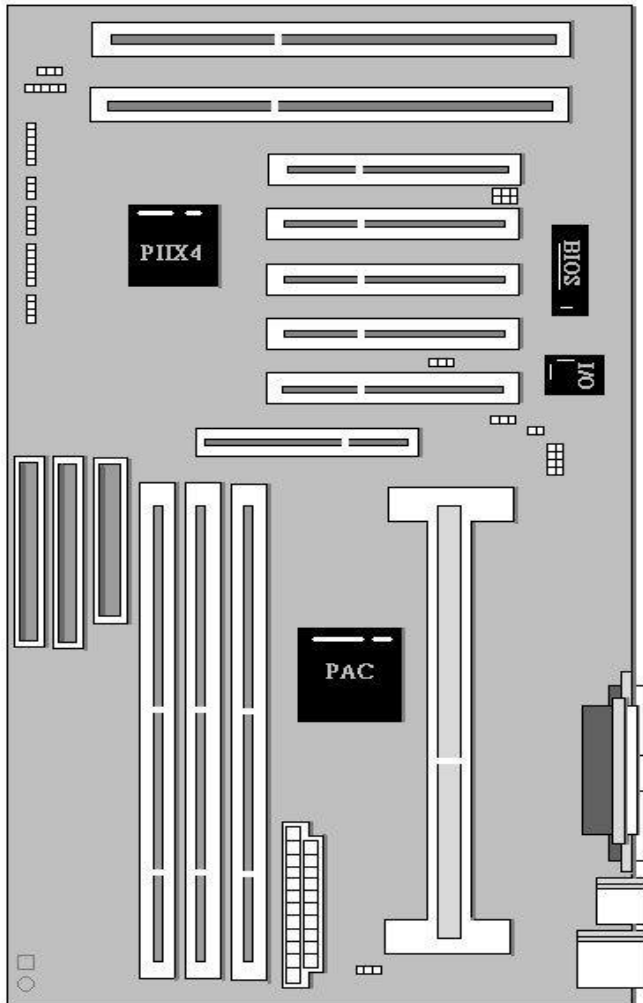

3. INSTALLATION

Significant Parts List

Front Panel Connectors

Speaker	Page23
Reset switch	Page23
Power LED	Page23
Hard drive activity LED	Page24
Infrared (IrDA) port	Page24
Sleep switch	Page24
Power switch	Page24

Back Panel Connectors

PS/2-style keyboard and mouse connectors	Page25
Two USB connectors	Page25
Two serials ports	Page26
One parallel port	Page26

Expansion Slots/Sockets

DIMM Sockets	Page18
SEC CPU Slot	Page16
ISA Slots	Page20
PCI Slots	Page20
AGP Slot	Page20

Power/IDE/FDD Connectors

Power connector	Page22
IDE connectors	Page21
FDD connector	Page22

Additional Connectors

CPU Fan	Page28
Chassis Fan	Page28
Key Lock	Page28
WOL Connector	Page27
SB-LINK Header	Page27

3. INSTALLATION

Precaution Before Start

Static Electricity Damage:



Static electricity can easily damage your motherboard. Observing a few basic precautions can help safeguard against damage that could result in expensive repairs. Follow the simple measures below to protect your equipment from static electricity damage:

1. Keep the motherboard and other system components in their anti-static packaging until you are ready to install them.
2. Touch a grounded surface before you remove any system component from its protective anti-static packaging. Unpacking and installation should be done on a grounded, anti-static mat. The operator should be wearing an anti-static wristband, grounded at the same points as the anti-static mat.
3. After removing the motherboard from its original packaging, only place it on a grounded, anti-static surface component side up. Immediately inspect the board for damage. Due to shifting during shipping, it is suggested that the installer press down on the entire socket ICs to ensure they are properly seated. Do this only with the board placed on a firm flat surface.
4. During configuration and installation touch a grounded surface frequently to discharge any static electrical charge that may have built up in your body. The best precaution is to wear a grounded wrist strap. When handling the motherboard or an adapter card avoids touching its components. Handle the motherboard and adapter cards either by the edges or by the adapter card case-mounting bracket.

Misplaced Jumper Damage:



There are critical headers used for connectors or power sources. These are clearly marked separately from the jumpers listed in Motherboard Layout. Incorrectly setting jumpers and connectors may lead to damage to your motherboard. Please pay special attention not to connect these headers in wrong directions.

3. INSTALLATION

3.1 Slots And Connectors

This motherboard requires no jumper setting for CPU speed. All settings will be completed in BIOS. In Chapter 4, you will be navigated to set the CPU speed in **BIOS Features Setup Menu**. This motherboard will automatically configure a correct voltage for the CPU making voltage jumpers unnecessary.

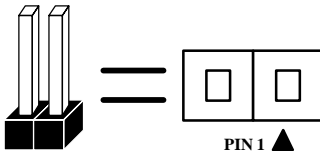

In following pages, the triangle ▲ mark stands for pin 1 of connectors.

Slots/Connectors List

- 1) J1: Mouse / Keyboard
- 2) J2: Serial Port (COM 2)
- 3) J3: Serial Port (COM 1)
- 4) J4: USB1 / USB2
- 5) J5: Parallel Port
- 6) J6-J10: PCI Slots
- 7) J11: WOL (Wake On LAN) Connector
- 8) J12: AGP (Accelerated Graphics Port) Slot
- 9) J13: CPU Fan
- 10) J14: Primary IDE
- 11) J15: ATX Power Connector
- 12) J16: Chassis Fan
- 13) J17: Key Lock & Power LED
- 14) J18: Secondary IDE
- 15) J19: Floppy Connector
- 16) J20: Speaker
- 17) J21: Reset
- 18) J22: Power LED
- 19) J23: HDD LED
- 20) J24: IrDA (Infrared Data Association)
- 21) J25: Sleep
- 22) J26: Power Switch
- 23) J27: SB-LINK Header

3. INSTALLATION

3.2 CPU (Central Processing Unit)

This motherboard provides a Single Edge Contact (SEC) slot and a Bridges on the board for the Pentium II processor packaged in a SEC cartridge. This cartridge includes the processor core, second-level cache, thermal plate and black cover. When mounted in Slot 1, the processor is secured by a retention mechanism attached to the motherboard.

Also this motherboard can be upgraded with Pentium II processors that run at higher speeds. When upgrading the processor, use the BIOS configuration mode to change the processor speed.

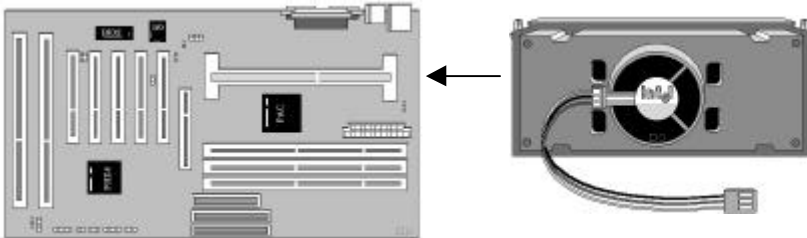

First, please ensure the following parts we received with this motherboard:

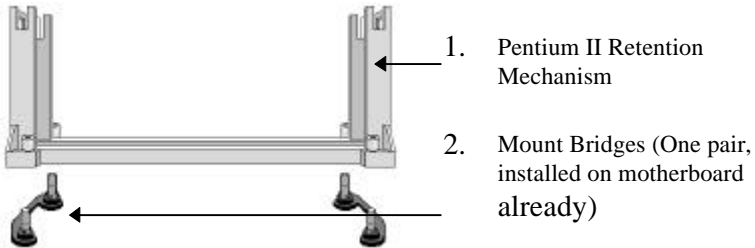

In your Packaging, one Pentium II Retention Mechanism is attached and one pair of Mount Bridges is installed on the motherboard.

3. INSTALLATION

Next follow the following steps to complete CPU Installation.

Step 1:

Place the Pentium II Retention Mechanism over the CPU slot (SEC slot) on motherboard. It is designed to fit only one way into CPU slot.



Captive Nut

Retention Mechanism



SEC Slot Mount Bridges

Step 2:

Fix the Pentium II Retention Mechanism to the motherboard by screwing the four captive nuts tight to Mounting Bridges.

Step 3:

Push the SEC Cartridge's two locks (shown as right) inward and insert the CPU (SEC Cartridge) to Retention Mechanism. Press the top of CPU gently but firmly until it is fully inserted.

Finally, make sure the SEC Cartridge has been installed Properly, then connect the CPU Heatsink Fan cable to the onboard CPU Fan header (J13).

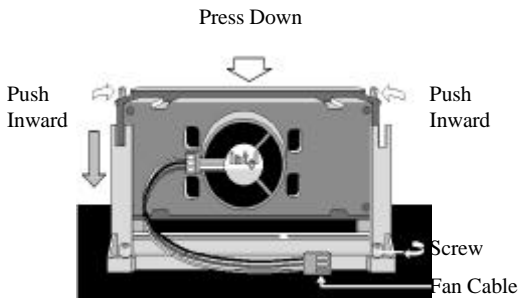

WARNING: The Pentium II CPU Cartridge may be easily overheated and damaged in case of without a fan, also the motherboard will be damaged. Besides, the insufficient airflow will cause the same situation.

3. INSTALLATION

Step 4:
Setting CPU speed jumper block JP2

Processor core speed	System bus speed	7-8	5-6	3-4	1-2
7/2 (233MHz)	66.66MHz	Close	Open	Close	Open
4 (266MHz)	66.66MHz	Close	Close	Open	Close
9/2 (300MHz)	66.66MHz	Close	Open	Open	Close
5 (333MHz)	66.66MHz	Close	Close	Open	Open
3 (300MHz)	100MHz	Close	Close	Close	Open
7/2 (350MHz)	100MHz	Close	Open	Close	Open
4 (400MHz)	100MHz	Close	Close	Open	Close
9/2 (450MHz)	100MHz	Close	Open	Open	Close

3. INSTALLATION

3.3 System Memory (DRAM)

3.3.1 DIMM (Dual Inline Memory Module)

The QS440BX features three 168-pin DIMM sockets, each supporting 8MB, 16MB, 32MB, 64MB and 128 MB of SDRAM/EDO. Memory can be installed in one, two or all three sockets. Memory size and speed can vary between sockets. Also variable memory can be combined for a total memory of 8MB to 384MB with variable combination. The BIOS will automatically detects memory type, size and speed.

3.3.2 Installation Procedure

Step1: Pin 1 of the DIMM must match pin 1 of the DIMM socket.

Step2: Insert the DIMM module into the DIMM socket at a 90-degree angle. If pin 1 of the DIMM module does not line up with pin 1 of the socket, the DIMM module will not insert correctly into the socket.

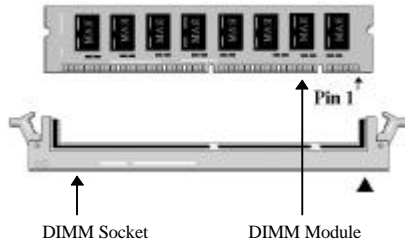

Step 3: After inserting the DIMM module completely into the socket, push up on the

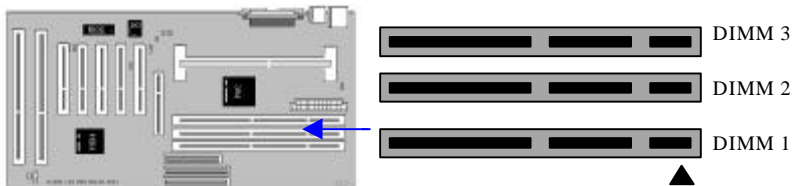

socket latches securing the DIMM into place.

Be careful not to misfit the DIMM Module into DIMM sockets in wrong direction. This module can be inserted into DIMM socket only one way. Please note the “▲” for pin 1 location.

To release the memory module, push both latches down and carefully rock the module forward and backward while slowly lifting it upward.

3. INSTALLATION

3.4 Expansion Slots

This motherboard contains 8 expansion slots onboard. Two 16-bit ISA Bus, five 32-bit

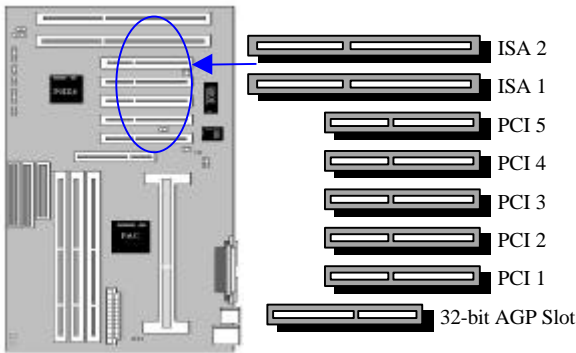

PCI expansion slots and one 32-bit AGP slot as shown above.

One PCI and one ISA are shared to accommodate either an ISA or a PCI expansion cards, but not both at the same time. All five PCI expansion slots accept PCI as master cards and are fully supported by the PCI 2.1 specification.

The Accelerated Graphics Port (AGP or A.G.P.) is a high performance interconnect targeted at 3D graphical display applications and is based on a set of performance extensions or enhancements to the PCI bus. (AGP interface specification Rev. 1.0 compliant)

To install expansion cards, please read the expansion card's documentation for instructions and cautions.

Notice: Some expansion cards require an IRQ to work and may cause a conflict. There are total of 16 IRQs with some reserved for expansion cards. In case of a conflict please contact the system manufacturer for technical support.

3. INSTALLATION

3.5 Connectors

Here in the motherboard contains IDE, floppy, power input, front panel, back panel and additional connectors.

3.5.1 Primary IDE Connector (J14, 39-pin block)

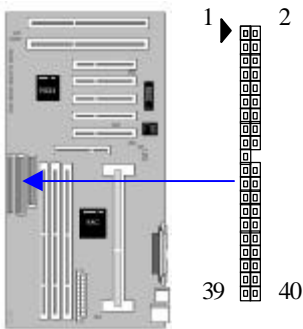

This connector supports two primary channel IDE devices via a ribbon cable. When two IDE devices are installed using the primary IDE connector, make sure that the second IDE device is set to slave mode as indicated in the device's manual.

WARNING: When you connect a ribbon cable to these ports, you must orient the cable connector so that the PIN 1 edge of the cable is at the PIN 1 edge of the onboard connector.

3.5.2 Secondary IDE Connector (J18, 39-pin block)

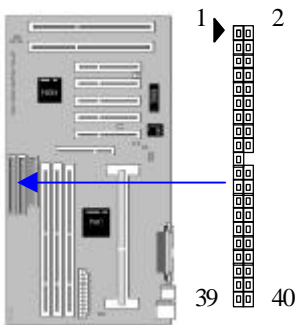

This connector supports two secondary channel IDE devices as well as the 120MB Floppy drives via a ribbon cable. When two IDE devices are installed using the secondary IDE connector, make sure that the second IDE device is adjusted to slave mode as instructed in the device's manual.

WARNING: When you connect a ribbon cable to these ports, you must orient the cable connector so that the PIN 1 edge of the cable is at the PIN 1 edge of the onboard connector.

3. INSTALLATION

3.5.3 Floppy Drive Connector (J19, 33-pin block)

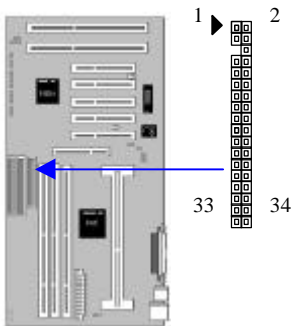

The FDC sub-system can control three types of floppy drives (1.2, 1.44 and 2.88MB) or compatible tape drives. The connection to the floppy drive is via a header (J19). The floppy disk interface includes 48mA drivers and inputs on the drive interface.

WARNING: When you connect a ribbon cable to this port, you must orient the cable connector so that the PIN 1 edge of the cable is at the PIN 1 end of the onboard port.

3.5.4 Power Input Connector (J15, 20-pin block)

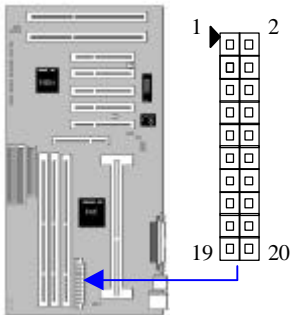

This connector supports a standard ATX power supply. When connecting, make sure the lock key matches the hook attached on a power supply cable. The power cord should be unplugged when you

WARNING: Make that the ATX Power Supply can take at least 10-mA load on the 5-Volt Standby lead (5VSB). You may experience difficulty in powering on your system without this.

connect it.

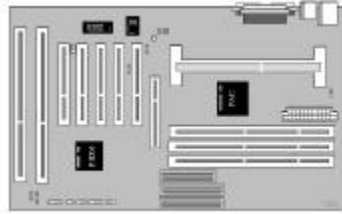

3.5.5 Front Panel connectors (J20-J26)

Front Panel includes headers for the following seven I/O connectors:
Speaker, Reset Switch, Power LED, Hard drive activity LED, Infrared (IrDA) port, Sleep Switch, Power Switch
Please refer to the following figure.
Front Panel connectors:

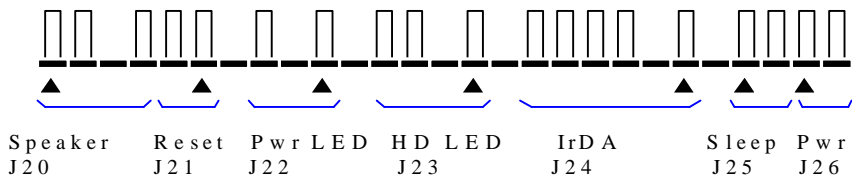

Speaker Connector or Onboard Buzzer (J20, 4-pin)

It is used to drive a chassis-mounted speaker.
 This header can select between the chassis speaker and internal buzzer by installing a cap over pin1&2. When the chassis mounted speaker is needed the jumper should be removed.

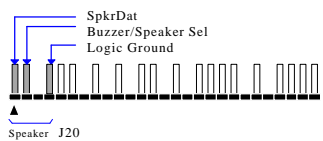

Reset Switch Connector (J21, 2-pin)

This connector supports the front panel case-mounted reset button. It is advised that the reset switch be used for rebooting the system in order to extend the life of the system's power supply.

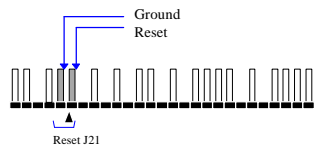

3. INSTALLATION

Power LED/Sleep/Message Waiting (J22, 3-pin)

This header can be connected to an LED that will light when the computer is powered on.

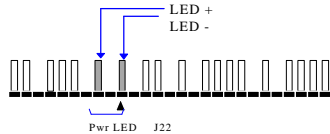

LED Status	Description
Light Off	Power Off
Light On	Power On
Flash	Sleep

HDD LED Connector (J23, 4-pin)

The QS440BX supports one straight 4-pin header for connecting to front Panel Hard Disk activity LED indicator.

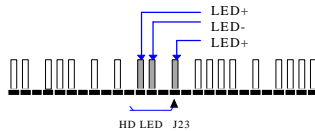

Infrared (IrDA) connector (J24, 6-pin)

The QS440BX offers an IrDA infrared header that supports third party infrared modules. The case must reserve space for the IR module if you want to use the IrDA function. This option supports wireless transmission and reception of infrared data. The module mounts in a small opening on the system case that supports this feature. The efficient distance is 100cm and the transfer rate is 1.44M KB/sec.

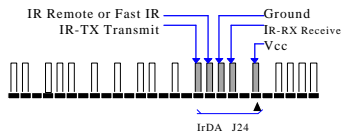

3. INSTALLATION

Sleep Switch (J25, 2-pin)

When the APM (Advanced Power Management) feature is enabled in the system BIOS and the operating system's APM driver is loaded, the system can enter the sleep (standby) mode in one of the following ways:

- Optional front panel sleep/resume button
- Prolonged system inactivity using the BIOS inactivity timer feature (see Section 4.5)

The 2-pin header supports a front panel sleep/resume switch, which must be a momentary SPST type that is normally open

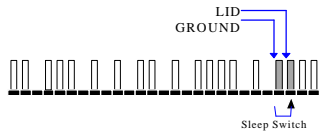

Power Switch (J26, 2-pin)

This connector supports the ATX case-mounted Power Switch, which in turn supports System Suspend function. When the BIOS sets the Power Button function to “Suspend”, the system can be set to the suspended mode once you push the power switch for no longer then 4 seconds. If the power switch is pushed down for over 4 seconds the system will be totally Power Off. When the BIOS setting sets the Delay 4 second to “On/Off”, then Power Switch function work as regular power switch.

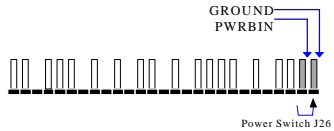

3. INSTALLATION

3.5.6 Back Panel Connectors

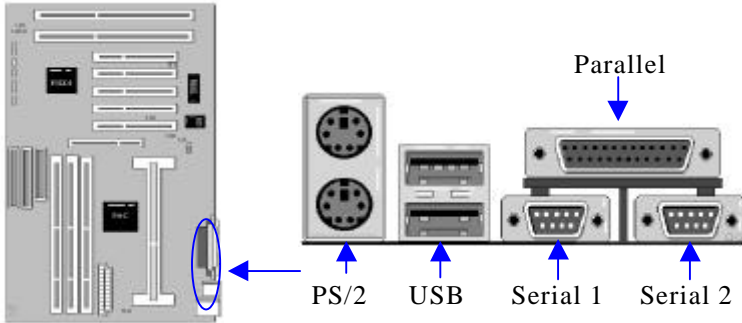

PS/2 Keyboard and Mouse Ports

The motherboard offers 1 PS/2 Keyboard and 1 PS/2 Mouse port.

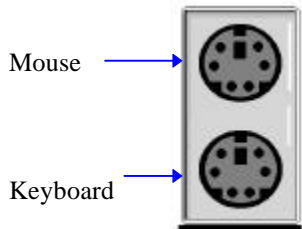

Universal Serial Bus (USB) Ports



USB 2

USB 1

The motherboard has two USB connectors. USB devices provide a more convenient operating environment and improve data transferring capacity. True Plug & Play, this new bus technology will support over 127 different peripherals through a Hub.

3. INSTALLATION

Parallel Port

The QS440BX includes a parallel port (EPP/ECP compatible). The parallel port is capable of being disabled or remapped to either the secondary LPT address or the primary LPT address through BIOS if another parallel port is installed. The parallel port contains 12mA source output drivers on the drive interface and incorporates “Chip Protect” circuitry for protection against damage due to printer’s power being on.

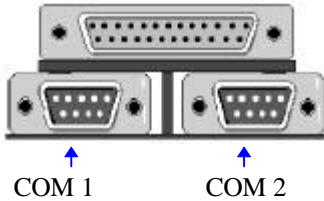
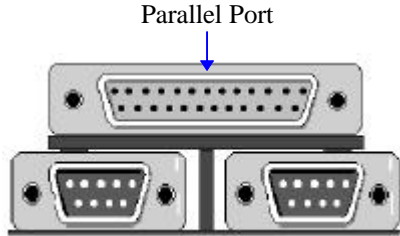

Serial Port

The motherboard has two serial ports. The electrical characteristics are compliant with the EIA-232-D Serial Communications Specifications. The serial ports may be remapped over other installable serial ports or disabled through the BIOS.

3. INSTALLATION

3.5.7 Additional Connectors

SB-LINK Header

To support the legacy Sound Blaster compatible Audio to the PCI bus.

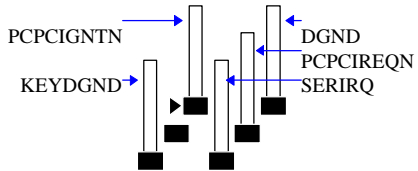

WOL (Wake On LAN)

This header is used for remote wakeup of the computer through a network. WOL requires a PCI add-in network interface card (NIC) with remote wakeup capabilities. The remote wakeup capabilities on the NIC must be connected to the onboard Wake on LAN header. For Wake on LAN, the

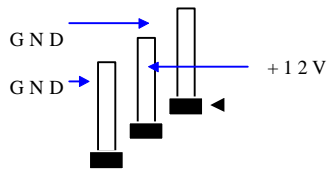

5-V standby line for the power supply must be capable of delivering 5V±5% at 720mA.

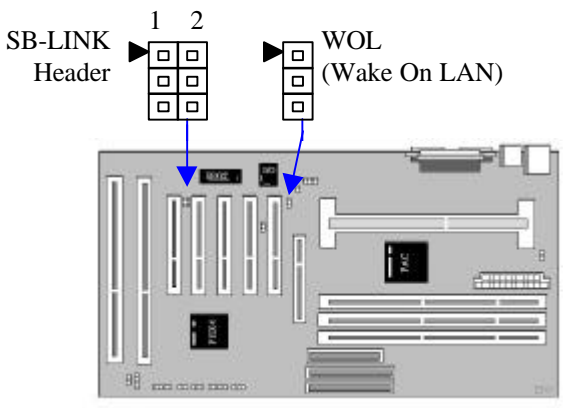

3. INSTALLATION

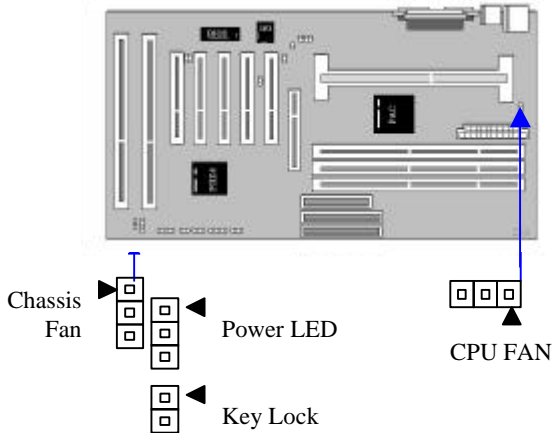

Chassis Fan Headers

This header can supply power for Chassis Fan which may be mounted inside your case to cool down your system components. If your chassis have a Chassis Fan, this header will support it.

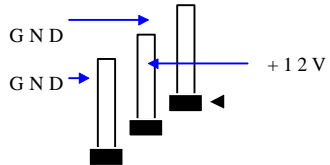

Key Lock/Power LED Header

This header combine Key Lock and Power LED. The Power LED is as same as the Power LED connector found in the Front Panel Connectors. You can lock your system by using a Key Lock on your case supports it.

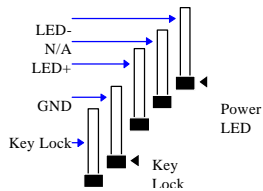

CPU Fan

Your Pentium II Cartridge may have an attached heatsink and Fan; this connector is for the CPU Fan.

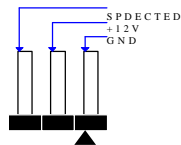

3. INSTALLATION

Ready To Turn On Power

- **Check Again**



1. Is the CPU Cartridge installed exactly and firmly into Retention Mechanism (Sec. 3.2)?
2. Are all the DRAM modules installed properly (Sec. 3.3)?
3. Did you insert expansion card (VGA, Sound.... etc.) already (Sec. 3.4)?
4. Are you sure that all the connectors (described in Sec 3.5) have been connected to their variable devices (Sec. 3.5)?

- **Yes, I have checked and assured the above steps!**



Now get ready to turn on your device using the following steps.

1. Mount your motherboard to the chassis frame and close the case cover.
2. Switch off all power.
3. Connect the power supply cord into inlet of the system case.
4. Connect the power supply cord into an outlet of power supply.
5. Connect Monitor signal cable to system VGA port, and the monitor power cord to power outlet.
6. Now turn on monitor and system power.

After Power on, The power LED on the front panel of the system case will light. For ATX power supplies, the system LED will light when the ATX power switch is pressed.

The system will then do a power-on tests item by item, and additional messages will appear on screen. If the screen blinks or the tests stops more than 30 seconds, the system may have failed the power-on test. If so, please recheck the above steps or call your retailer for assistance.

If the power-on test goes well, hold down <Delete> button on the keyboard to enter BIOS Setup. Next, follow the instructions in the next chapter, **BIOS**

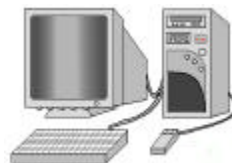

SETUP.

4. BIOS SETUP



The QS440BX motherboard uses AWARD BIOS, which is stored in a Flash EEPROM and can be upgraded by a floppy disk-based program. The BIOS has a built-in Setup Program that allows users to modify the basic system configuration settings. The settings are then stored in a dedicated

battery-backed memory, called CMMOS RAM that retains the information when the power is turned off. The BIOS provides critical low-level support for the system's central processing, memory and I/O subsystems. The AWARD BIOS has been customized by adding important, nonstandard, features such as virus and password protection, power management, and detailed fine-tuning of the chipset which controls the system. The remainder of this manual is intended to guide you through the process of configuring your system using the BIOS Setup.

4.1 How To Enter BIOS Setup

The AWARD BIOS is immediately activated when you first turn on the computer. The BIOS reads system configuration information in CMOS RAM and begins the process of checking the system and configuring it through the power-on self test (POST). When these preliminaries are finished, the BIOS seek an operation system on the data storage devices (hard drive, floppy drive, etc.). The BIOS launches the operating system and hands over control of system operation to it.

To start Setup, press the key during boot-up before or while a message similar to this appears briefly at the bottom of the screen during POST (Power On Self Test):

Press DEL if you want to enter SETUP

If the above message disappears before you have responded and you still wish to enter Setup, reboot the system to try again by pressing the "RESET" button on the system case. You may also restart by simultaneously pressing the <Ctrl>, <Alt> and <Delete> keys.

Press **F1** to continue, **DEL** to enter **SETUP**

4.1.1 Setup Keys

These keys help you navigate in Setup:

<↑> , <↓>	Move to previous or next item
<<-> , <->	Move to the item in the left or right hand
<Esc>	Main Menu – Quit and not save changes into CMOS Other Pages -- Exit current page and return to Main Menu
<PgUp> / <+>	Increase the numeric value or make changes
<PgDn> / <->	Decrease the numeric value or make changes
<F1>	General help, only for Status Page Setup Menu and Option Page Setup Menu
<F2>	Change color from total 16 colors. F2 to select Shift-F2 color forward, Shift-F2 to select color backward
<F3>	Calendar, only for Status Page Setup Menu
<F5>	Restore the previous CMOS value from CMOS, only for Option Page Setup Menu
<F7>	Load the Setup default
<F10>	Save all the CMOS changes, only for Main Menu

4.1.2 Getting Help

Press F1 to pop up a small help window that describes the appropriate keys to use and the possible selections for the highlighted item. To exit the Help Window press Esc or the F1 key again.

4.1.3 In Case of Problems

If after making and saving system changes with Setup, you discover that your computer no longer is able to boot, the Award BIOS supports an override to the CMOS settings that resets your system to its default configuration.

You can invoke this override by immediately pressing Insert; when you restart your computer You can restart by either using the ON/OFF switch, the RESET button or by pressing Ctrl-Alt-Delete.

The best advice is to alter only settings that you thoroughly understand. In particular, do not change settings in the Chipset screen without a good reason. BCM Advanced Research Inc. or your system manufacturer for the best performance and reliability has carefully chosen the Chipset defaults. Even a seemingly small change to the Chipset setup may cause the system to become unstable.

4.2 Main Setup Menu

When you enter the Award BIOS CMOS Setup Utility, a Main Menu (Figure 1) appears on the screen. The Main Menu allows you to select from several Setup functions and two exit choices. Use the arrow keys to select among the items and press Enter to accept and enter the sub-menu.

A brief description of each highlighted selection appears at the bottom of the screen.

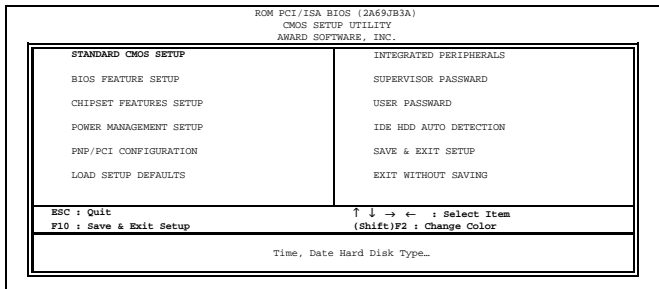

Figure 1

Following is a brief summary of each Setup category.

Standard CMOS	Options in the original PC AT-compatible BIOS.
BIOS Features	Award enhanced BIOS options.
Chipset Features	Options specific to your system chipset.
Power Management	Advanced Power Management (APM) options.
PnP/PCI Configuration	Plug and Play standard and PCI Local Bus configuration options.
Integrated Peripherals	I/O subsystems that depend on the integrated peripherals controller in your system.
Supervisor/User	Change, set, or disable a password. In BIOS versions that allow

Password Setting	separate user and supervisor passwords, only the supervisor password permits access to Setup. The user password generally allows only power-on access.
IDE HDD Auto Detection	Automatically detect and configure IDE hard disk parameters.
Load Setup Defaults	Setup defaults are factory settings for optimal-performance system operations.
Save & Exit Setup	Save settings in nonvolatile CMOS RAM and exit Setup.
Exit Without Save	Abandon all changes and exit Setup.

4.3 Standard CMOS Setup Menu

In the Standard CMOS Menu (Figure 2) you can set the system clock and calendar, record disk drive parameters and the video subsystem type, and select the type of errors that stop the BIOS POST.

ROM PCI/ISA BIOS (2A69JB3A)						
STANDARD CMOS SETUP						
AWARD SOFTWARE, INC.						
Date (mm:dd:yy) : Sun, May 12 1996						
Time (hh:mm:ss) : 10 : 10 : 00						
HARD DISKS	TYPE	SIZE	CYLs	HEAD	PRECOMP	
Primary Master	: Auto	0	0	0	0	0
Primary Slave	: Auto	0	0	0	0	0
Secondary Master	: Auto	0	0	0	0	0
Secondary Slave	: Auto	0	0	0	0	0
Drive A	: 1.44MB, 3.5 in.					Base Memory: 640K
Drive B	: None					Extended Memory: 31744K
						Other Memory: 384K
Video	: EGA/VGA					Total Memory: 32768K
Halt On	: All Errors					
ESC : Quit		↑ ↓ → ← : Select Item				PU/PD/+/- : Modify
F1 : Help		(Shift)F2 : Change Color				

Figure 2

4.3.1 Date

The BIOS determines the day of the week from the other date information. This field is for information only. Press the left or right arrow key to move to the desired field (date, month, year). Press the PgUp or PgDn key to increment the setting, or type the

desired value into the field.

4.3.2 Time

The time format is based on the 24-hour military-time clock. For example, 1 p.m. is 13:00:00. Press the left or right arrow key to move to the desired field. Press the PgUp or PgDn key to increment the setting, or type the desired value into the field.

4.3.3 Hard Disks

The BIOS supports up to four IDE drives. This section does not show information about other IDE devices, such as a CD-ROM drive, or about other hard drive types, such as SCSI drives.

NOTE: We recommend that you select type AUTO for all drives.

The BIOS can automatically detect the specifications and optimal operating mode of almost all IDE hard drives. When you select type AUTO for a hard drive, the BIOS detects its specifications during POST, every time the system boots.

If you do not want to select drive type AUTO, other methods of selecting the drive type are available:

- 1) Match the specifications of your installed IDE hard drive(s) with the preprogrammed values for drive types 1 through 45.
- 2) Select USER and enter values into each drive parameter field.
- 3) Use the IDE HDD AUTO DETECTION function in Setup.

Here is a brief explanation of drive specifications:

- **Type:** The BIOS contains a table of pre-defined drive types. Each defined drive type has a specified number of cylinders, number of heads, write precompensation factor, landing zone, and number of sectors. Drives whose specifications do not accommodate any pre-defined type are classified as type USER.
- **Size:** Disk drive capacity (approximate). Note that this size is usually slightly greater than the size of a formatted disk given by a disk-checking program.
- **Cyls:** Number of cylinders
- **Head:** Number of heads

- Precomp: Write precompensation cylinder
- Landz: Landing zone
- Sector: Number of sectors
- Mode: Auto, Normal, large, or LBA
 - Auto: The BIOS automatically determines the optimal mode.
 - Normal: Maximum number of cylinders, heads, and sectors supported are 1024, 16 and 63.
 - Large: For drives that do not support LBA and have more than 1024 cylinders.
 - LBA (Logical Block Addressing): During drive accesses, the IDE controller Transforms the data address described by sector, head, and cylinder number into a physical block address, significantly improving data transfer rates. For drives with greater than 1024 cylinders.

4.3.4 Drive A/B type

Select the correct specifications for the diskette drive(s) installed in the computer.

None	No diskette drive installed
360K, 5.25 in	5-1/4 inch PC-type standard drive; 360 kilobyte capacity
1.2M, 5.25 in	5-1/4 inch AT-type high-density drive; 1.2 megabyte capacity
720K, 3.5 in	3-1/2 inch double-sided drive; 720 kilobyte capacity
1.44M, 3.5 in	3-1/2 inch double-sided drive; 1.44 megabyte capacity
2.88M, 3.5 in	3-1/2 inch double-sided drive; 2.88 megabyte capacity

4.3.5 Video

Select the type of primary video subsystem in your computer. The BIOS usually detects the correct video type automatically. The BIOS supports a secondary video subsystem, but you do not select it in Setup.

EGA/VGA	Enhanced Graphics Adapter/Video Graphics Array. For EGA, VGA, SEGA, SVGA or PGA monitor adapters.
CGA 40	Color Graphics Adapter, power up in 40 column mode.

CGA 80	Color Graphics Adapter, power up in 80 column mode.
MONO	Monochrome adapter includes high-resolution monochrome adapters.

4.3.6 Halt on

During the power-on self-test (POST), the computer stops if the BIOS detect a hardware error. You can tell the BIOS to ignore certain errors during POST and continue the boot-up process. These are the selections:

No errors	POST does not stop for any errors.
All errors	If the BIOS detect any non-fatal error, POST stops and prompts you to take corrective action.
All, But Keyboard	POST does not stop for a keyboard error, but stops for all other errors.
All, But Diskette	POST does not stop for diskette drive errors, but stops for all other errors.
All, But Disk/Key	POST does not stop for a keyboard or disk error, but stops for all other errors.

4.3.7 Memory

You cannot change any values in the Memory fields; they are only for your information. The fields show the total installed random access memory (RAM) and amounts allocated to base memory, extended memory, and other (high) memory, RAM is counted in kilobytes (KB: approximately one thousand bytes) and megabytes (MB: approximately one million bytes).

RAM is the computer's working memory, where the computer stores programs and data currently being used, so they are accessible to the CPU. Modern personal computers may contain up to 64MB, 128MB, or more.

Base Memory

Typically 640 KB. Also called conventional memory. The DOS operating system and conventional applications use this area.

Extended Memory

Above the 1-MB boundary. Early IBM personal computers could not use memory above 1 MB, but current PCs and their software can use extended memory.

Other Memory

Between 640 KB and 1 MB; often called High memory. DOS may load terminate-and-stay-resident (TSR) programs, such as device drivers, in this area, to free as much conventional memory as possible for applications. Lines in your CONFIG.SYS file that start with LOADHIGH load programs into high memory

Total memory

System total memory is the sum of base memory, extended memory, and other memory.

4.4 BIOS Features Setup Menu

This screen (Figure 3) contains industry-standard options additional to the core PC AT BIOS. This section describes all fields offered by Award Software in this screen. Some fields may vary from those in your Setup program. Your system board designer may omit or modify some fields.

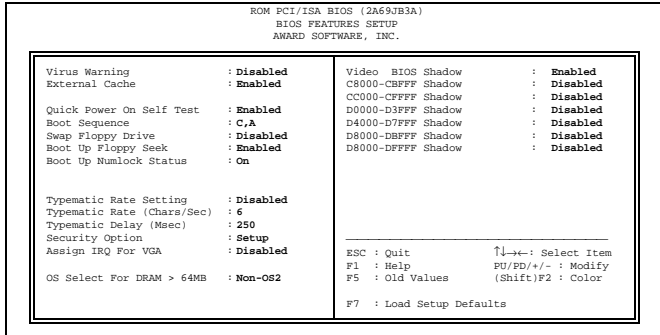

Figure 3

4.4.1 Virus Warning

When enabled, you receive a warning message if a program (specifically, a virus) attempts to write to the boot sector or the partition table of the hard disk drive. You should then run an anti-virus program. Keep in mind that this feature protects only the boot sector, not the entire hard drive.

NOTE: Many disk diagnostic programs that access the boot sector table can trigger the virus-warning message. If you plan to run such a program, we recommend that you first disable the virus warning.

4.4.2 CPU Level 1/Level 2 Cache

Cache memory is additional memory that is much faster than conventional DRAM (system memory). Pentium II CPU has Level 1 and Level 2 build-in cache. These fields allow you to Enabled (Default) or Disabled to turn on or turn off the memory cache ability.

4.4.3 Boot Sequence

The original IBM PCs loaded the DOS operating system from drive A (floppy disk), so IBM PC-compatible systems are designed to search for an operating system first on drive A, and then on drive C (hard disk). However, the BIOS now offers 10 different boot sequences options of three drive each. In addition to the traditional drives A and C, options include IDE hard drives D, E, and F; plus a SCSI hard drive and a CD-ROM drive.

4.4.4 Swap Floppy Drive

This field is effective only in systems with two floppy drives. Selecting *Enabled* assigns physical drive B to logical drive A, and physical drive A to logical drive B.

4.4.5 Boot Up Floppy Seek

When *Enabled*, the BIOS tests (seeks) floppy drives to determine whether they have 40 or 80 tracks. Only 360-KB floppy drives have 40 tracks; drives with 720 KN< 1.2MB, and 1.44MB capacity all have 80 tracks. Because very few modern PCs have 40-track floppy drives, we recommend that you set this field to *Disabled* to save time.

4.4.6 Boot Up NumLock Status

Toggle between *On* or *off* to control the state of the NumLock key when the system boots. When toggled *on*, the numeric keypad generates numbers instead of controlling cursor operations.

4.4.7 Typematic Rate Setting

When *Disabled*, the following two items (Typematic Rate and Typematic Delay) are irrelevant. Keystrokes repeat at a rate determined by the keyboard controller in your system. When *Enabled*, you can select a typematic a\rate and typematic delay.

4.4.8 Typematic Rate (Chars/Sec)

When the typematic rate setting is enabled, you can select a typematic rate (the rate at which character repeats when you hold down a key) of 6,8,10,12,15,20,24, or 30 characters per second.

4.4.9 Typematic Delay (Msec)

When the typematic rate setting is enabled, you can select a typematic delay (the delay before keystrokes begin to repeat) of 250, 500, 750 or 1000 milliseconds.

4.4.10 Security Option

If you have set a password, select whether the password is required every time the

System boots, or only when you enter Setup.

4.4.11 PCI/VGA Palette Snoop

Some display cards that are not standard VGA such as graphics accelerators or MPEG cards may not show the correct colors, the setting can correct this problem once you set it to Enable, To default setting leave at Disabled.

4.4.12 OS select for DRAM>64MB

Select OS2 only if you are running OS/2 operating system with greater than 64MB of RAM on your system.

4.4.13 Shadow

Software that resides in a read-only memory (ROM) chip on a device is called *firmware*. The Award BIOS permits *shadowing* of firmware such as the system BIOS, video BIOS, and similar operating instructions that come with some expansion peripherals, such as, for example, a SCSI adapter.

Shadowing copy firmware from ROM into system RAM, where the CPU can read it through the 16-bit or 32-bit DRAM bus. Firmware not shadowed must be read by the system through the 8-bit x-bus. Shadowing improves the performance of the system BIOS and similar ROM firmware for expansion peripherals, but it also reduces the amount of high memory (640KB to 1 MB) available for loading device drivers, etc.

Enable shadowing into each section of memory separately. Many system designers hardwire shadowing of the system BIOS and eliminate a System BIOS Shadow option.

Video BIOS shadows into memory area C0000-C7FFF> The remaining areas shown on the BIOS Features Setup screen may be occupied by other expansion card firmware. If an expansion peripheral in your system contains ROM-based firmware, you need to know the address range the ROM occupies to shadow it into the correct area of RAM.

4.5 Chipset Features Setup Menu

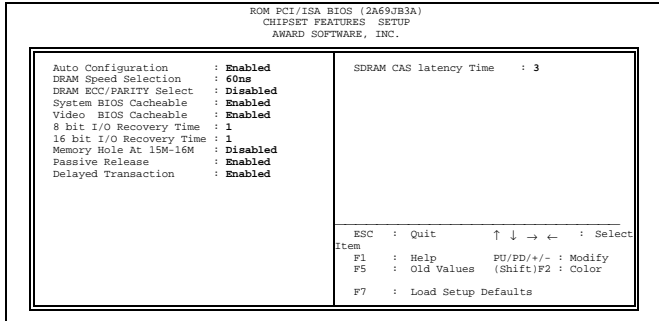

Figure 4

4.5.1 Auto Configuration

Auto Configuration selects predetermined optimal values of chipset parameters. When *Disabled*, chipset parameters revert to setup information stored in CMOS. Many fields in this screen are not available when Auto Configuration is *Enabled*.

4.5.2 DRAM Speed Selection

The value in this field must correspond to the speed of the DRAM installed in your system. **DO NOT** change the default setting of this fields, as determined by the system board manufacturer for the installed DRAM. This value is access speed, so a lower value means a faster system.

4.5.3 DRAM ECC/Parity Select

Select Parity, ECC, or Disabled, depending on the type of DRAM installed in your system. Also you need install Pentium II CPU cartridge with ECC support for ECC function properly once you installed 36-bit SIMM.

4.5.4 System BIOS Cacheable

Select Enabled allows caching of the system BIOS ROM at F000h-FFFFFh, resulting in better system performance. However, if any program writes to this memory area, a system error may result.

4.5.5 Video BIOS Cacheable

Select Enabled allows caching of the video BIOS ROM at F0000h-FFFFFh, resulting in better system performance. However, if any program writes to this memory area, a system error may result.

4.5.6 8 Bit I/O Recovery Time

The recovery time is the length of time, measured in CPU clocks, which the system will delay after the completion of an input/output request. This delay takes place because the CPU is operating so much faster than the input/output bus that the CPU must be delayed to allow for the completion of the I/O.

This item allows you to determine the recovery time allowed for 8 bit I/O. Choices are from NA, 1 to 8 CPU clocks.

4.5.7 16 Bit I/O Recovery Time

This item allows you to determine the recovery time allowed for 16 bit I/O. Choices are from NA, 1 to 4 CPU clocks.

4.5.8 Memory Hole At 15M-16M

In order to improve performance, certain space in memory can be reserved for ISA cards. This memory must be mapped into the memory space below 16 MB. You can reserve this area of system memory for ISA adapter ROM. When that area is reserved it cannot be cached. The user information of peripherals that need to use this area of system memory usually discusses their memory requirements.

4.5.9 Passive Release

When Enabled, CPU to PCI bus accesses are allowed during passive release. Otherwise, the arbiter only accepts another PCI master access to local DRAM.

4.5.10 Delayed Transaction

The chipset has an embedded 32-bit posted write buffer to support delay transactions cycles. Select Enabled to support compliance with PCI specification version 2.1.

4.6 Power Management Setup Menu

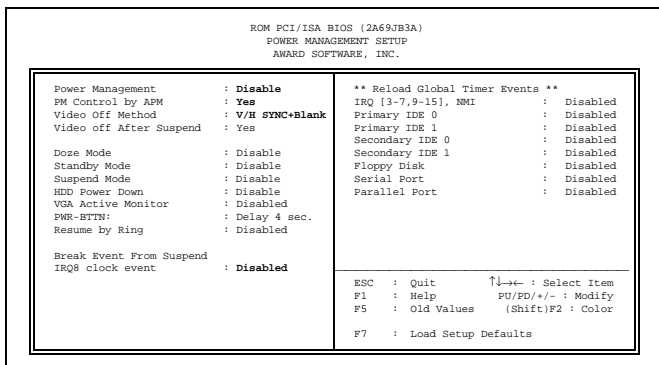

Figure 5

4.6.1 Power Management

This option allows you to select the type (or degree) of power saving for Doze, Standby, and Suspend modes. See the section *PM Timers* for a brief description of each mode. This table describes each power management mode:

Disable	Global Power Management will be disabled
Max Saving	Maximum power savings. Only Available for SL CPUs. Inactivity period is 1 minute in each mode.
User Define	Set each mode individually. Select time-out periods in the <i>PM Timers</i>

	section, following.
Min Saving	Minimum power savings. Inactivity period is 1 hour in each mode (except the hard drive).

4.6.2 PM Control by APM

If Advanced Power Management (APM) is installed on your system, selecting *Yes* gives better power savings.

4.6.3 Video Off Method

Determines the manner in which the monitor is blanked.

V/H SYNC+Blank	System turns off vertical and horizontal synchronization ports and writes blanks to the video buffer.
DPMS Support	Select this option if your monitor supports the Display Power Management Signaling (DPMS) standard of the Video Electronics Standards Association (VESA). Use the software supplied for your video subsystem to select video power management values.
Blank Screen	System only writes blanks to the video buffer.

4.6.4 Video Off After

As the system moves from lesser to greater power-saving modes, select the mode in which you want the monitor to blank.

4.6.5 Doze Mode

Defines the continuous idle time before the system entering DOZE mode. The range is from 1 min to 1 Hr. If any item defined is enabled & active, STANDBY timer will be reloaded

4.6.6 Standby Mode

After the selected period of system inactivity (1 minute to 1 hour), the fixed disk drive and the video shut off while all other devices still operate at full speed.

4.6.7 Suspend Mode

After the selected period of system inactivity (1 minute to 1 hour), all devices except the CPU shut off.

4.6.8 HDD Power Down

After the selected period of drive inactivity (1 to 15 minutes), the hard disk drive powers down while all other devices remain active.

4.6.9 VGA Active Monitor

When *Enabled*, any video activity restarts the global timer for Standby mode.

4.6.10 Soft-Off by PWR-BTTN

When this feature set to “Delay 4 sec.”, the system will become suspend once the Power Switch be pressed within 4 second, and the system will Power Off once the Power Switch be pressed over 4 second. If it set to “Instant Off”, the system will unconditional Power Off once the Power Switch be pressed.

4.6.11 Resume by Ring

The system will be awaked by telephone ring if this feature set to Enable

4.6.12 IRQ8 Clock Event

You can turn *On* or *Off* monitoring of IRQ8 (the Real Time Clock) so it does not awaken the system from Suspend mode.

4.6.13 Reload global Timer Events

When *Enabled*, an event occurring on each device listed below restarts the global time for Standby mode.

- IRQ3 -7, 9-15, NMI
- Primary IDE 0
- Primary IDE 1
- Secondary IDE 0
- Secondary IDE 1
- Floppy Disk
- Serial Port
- Parallel Port

4.7 PCI Configuration Setup Menu

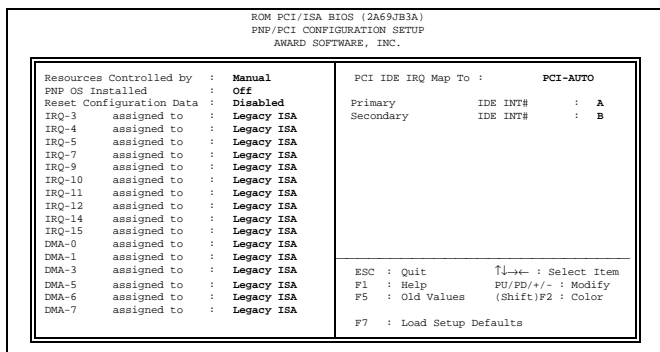

Figure 6

4.7.1 PNP OS Installed

The default setting is No when a non PNP OS installed or to prevent reassigning of interrupt setting for some of non PNP cards installed. Select Yes if the OS is PNP aware (e.g. Windows 95).

4.7.2 Resources Controlled by

The Award Plug and Play BIOS can automatically configure all the boot and Plug and Play-compatible devices. If you select Auto, all the interrupt request (IRQ) and DMA assignment fields disappear, as the BIOS automatically assign them.

4.7.3 Reset Configuration Data

Normally, you leave this field Disabled. Select Enabled to reset Extended System Configuration Date (ESCD) when you exit Setup if you have installed a new add-on and the system reconfiguration has caused such a serious conflict that the operating system cannot boot.

4.7.4 IRQ # Assigned to

When resources are controlled manually, assign each system interrupt as one of the following types, depending on the type of device using the interrupt.

Legacy ISA Devices compliant with the original PC AT bus specification, requiring a specific interrupt (such as IRQ4 for serial port 1).

PCI/ISA PnP Devices compliant with the Plug and Play standard, whether designed for PCI or ISA bus architecture.

4.7.5 DMA # Assigned to

When resources are controlled manually, assign each system DMA channel as one of the following types, depending on the type of device using the interrupt:

Legacy ISA Devices compliant with the original PC AT bus specification, requiring a specific DMA channel.

PCI/ISA PnP Devices compliant with the Plug and Play standard, whether designed for PCI or ISA bus architecture.

4.7.6 PCI IRQ Activated by

Leave the IRQ trigger set at Level unless the PCI device assigned to the interrupt specifies Edge-triggered interrupts.

4.7.7 PCI IDE IRQ Map To

This field lets you select PCI IDE IRQ mapping or PC AT (ISA) interrupts. If your system does not have one or two PCI IDE connectors on the system board, select values according to the type of IDE interface(s) installed in your system (PCI or ISA). Standard ISA interrupts for IDE channels are IRQ14 for primary and IRQ15 for secondary.

4.7.8 Primary/Secondary IDE INT#

Each PCI peripheral connection is capable of activating up to four interrupts: INT\$ A, INT# B, INT# C and INT#D. By default, a PCI connection s assigned INT3 A. Assigning INT#B has no meaning unless the peripheral device requires two interrupt services rather than just one. Because the PCI IDE interface in the chipset has two channels, it requires two interrupt services. The primary and secondary IDE INT# fields default to values appropriate for two PCI IDE channels, with the primary PCI IDE channel having a lower interrupt than the secondary.

4.8 Integrated peripherals Menu

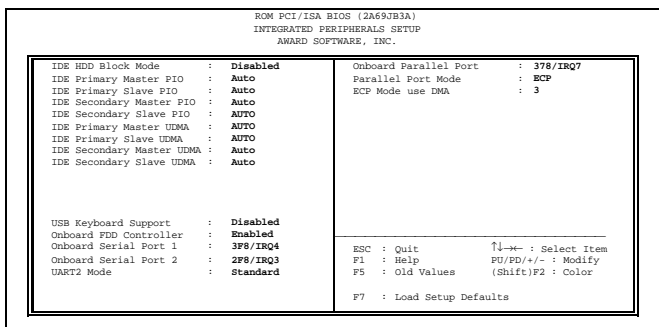

Figure 7

4.8.1 IDE HDD Block Mode

Block mode is also called block transfer, multiple commands, or multiple sector

read/write. If your IDE hard drive supports block mode (most new drives do), select Enabled for automatic detection of the optimal number of block read/writes per sector the drive can support.

4.8.2 On-Chip Primary/Secondary PCI IDE

The integrated peripheral controller contains an IDE interface with support for two IDE CHANNELS. Select Enabled to activate each channel separately.

4.8.3 Onboard FDC Controller

Select Enabled if your system has a floppy disk controller (FDC) installed on the system board and you wish to use it. If you install an add-in FDC or the system has no floppy drive, select disabled in this field.

4.8.4 Onboard Serial Port 1/2

Select an address and corresponding interrupt for the first and second serial ports.

4.8.5 UART2 Mode

Select the UART2 mode, there are 2 option Standard or IrDA.

4.8.6 Onboard Parallel Port

Select a logical LPT port name and matching address for the physical parallel (printer) port.

4.8.7 Onboard Parallel Mode

Select an operating mode for the onboard parallel (printer) port. Select Normal unless your hardware and software require one of the other modes offered in this field.

SPP	Standard parallel port mode (Default)
EPP	Bi-directional mode
ECP	Fast, buffered

ECP+EPP	Bi-directional and buffered
---------	-----------------------------

4.8.8 ECP Mode Use DMA

Select a DMA channel for the port.

4.8.9 USB Keyboard Support

Select Enabled if your system contains a Universal Serial Bus (USB) controller and you have a USB keyboard.

4.9 IDE HDD Auto Detection

BIOS setup will display all possible modes that supported by the HDD including NORMAL, LBA & LARGE.

If HDD does not support LBA modes, no 'LBA' option will be shown.

If no of cylinders is less than or equal to 1024, no "LARGE" option will be show

Users can select a mode, which is appropriate for them.

4.10 Password Setting

When you select this function, a message appears at the center of the screen:

ENTER PASSWORD:

Type the password, up to eight characters, and press Enter. Typing a password clears any previously entered password from CMOS memory. Now the message changes:

CONFIRM PASSWORD:

Again, type the password and press Enter.

To abort the process at any time, press Esc.

In the *Security Option* item in the **BIOS Features** Setup screen select *System or Setup*:

System Enter a password each time the system boots and whenever you enter Setup.

Setup Enter a password whenever you enter Setup.

NOTE: *To clear the password, simply press Enter when asked to enter a password. Then the password function is disabled.*