

Advanced Pentium II  
Motherboard

User's Manual

**GT440ZX**

USER'S MANUAL

# DECLARATION

## DECLARATION

### Rights:

**No part of this manual, including but not limited to the products and software described in it, may be reproduced, transmitted, transcribes, stored in a retrieval system, or translated in any form or by any means without the expressed written permission of the manufacture.**

Products and corporate names appearing in this manual may or may not be registered trademarks or copyrights of their respective companies and are used only for identification or explanation purposes without intent to infringe.

- ◆ Intel, MMX and Pentium are registered trademarks of Intel Corporation.
- ◆ IBM and OS/2 are registered trademarks of International Business Machines.
- ◆ AWARD is a registered trademark of Award Software Inc.

### Responsibility:

This manual is provided “As is” with no warranties of any kind, either expressed or implied, including, but not limited to the implied warranties or conditions of this product’s fitness for any particular purpose. In no event shall we be liable for any loss of profits, loss of business, loss of data, interruption of business, or indirect, special, incidental, or consequential damages of any kind, even the possibility of such damages arising from any defect or error in this manual or product. We reserve the right to modify and update the user manual without prior notice.

# COMPLIANCE & CERTIFICATE

## COMPLIANCE & CERTIFICATE

### ISO 9001 Certificate:



This device was produced in our plant with advanced quality system certified by DNV QA Ltd. in according to ISO 9001.

This Certificate is valid for:

DESIGN & MANUFACTURE OF MOTHER BOARDS AND PERSONAL COMPUTERS.

### CE Declaration:



CE marking is a visible declaration by the manufacturer or his authorized representatives that the electrical equipment to which it relates satisfies all the provisions of the 1994 Regulations.

### FCC Compliance:



**FCC** stands for **Federal Communications Commission**.

This product complies with FCC Rules Part 15 and has been tested, and complied with the EMI rules by a certified body.

In normal operation, there shall be no harmful interference caused by this device nor shall this device accept any interference received, including interference that may cause

undesired operation of this product.

### Year 2000 Compliance:



This product is tested to be qualified to bear the NSTL Year 2000 Compliant logo. Year2000 problem is mainly a problem of computer software (OS), and the hardware issue. With the support of BIOS on motherboard, the Y2K problem can be thoroughly conquered.

# EASY INSTALLATION

## EASY INSTALLATION

### Easy Installation Steps



The following “Easy Installation” steps are for users accustomed to the assembly of a computer system. For those individuals requiring more specific information please refer to the more detailed descriptions located within the latter chapters of this manual. **Note: You must keep your power cable unplugged until the following installation steps are completed.**

#### Getting Start:

**T**ouch a grounded metal surface to release static electricity stored in your body before unpacking your motherboard. For details please refer to **Precaution** section in **Chapter 3**.

Install the CPU by correctly aligning the CPU with the slot1 as noted in the motherboard diagram. Once aligned, press down on the CPU gently but firmly and lock it. Next, install the 3.3 volt unbuffered SDRAM into the 168 pin DIMMs. See **Sec. 3.2 & Sec. 3.3**.

Set CPU speed in according to **Sec.3.2**.

After completing the above steps, install any expansion Cards( PCI, ISA) into riser card and have the riser card installed firmly into the slot for riser card on board. See **Sec. 3.4**.

**P**lug in all cables included in the package except for the power cord. Please see **Sec. 3.5**.

Please recheck all steps to ensure no mistakes have been made and then plug in the power cord and turn on the power to enter the BIOS setup, **Chapter 4**.

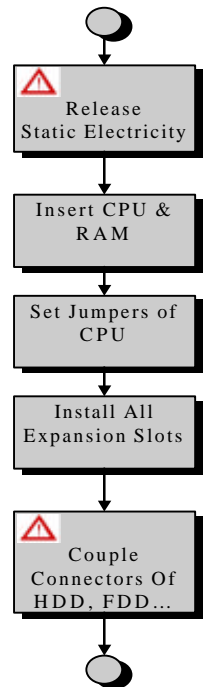

# **EASY INSTALLATION**

# CONTENTS

1	INTRODUCTION.....	8
2	FEATURES.....	9
3	INSTALLATION.....	12
3.1	SLOTS AND CONNECTORS .....	15
3.2	CPU (CENTRAL PROCESSING UNIT).....	16
3.2.1	<i>Install CPU.....</i>	16
3.2.2	<i>Set CPU Speed .....</i>	18
3.3	SYSTEM MEMORY (DRAM) .....	20
3.3.1	<i>DIMM (Dual Inline Memory Module).....</i>	20
3.3.2	<i>Installation Procedure.....</i>	20
3.3.3	<i>DIMM Module Combinations.....</i>	21
3.4	EXPANSION SLOTS .....	22
3.5	CONNECTORS.....	23
3.5.1	<i>Primary IDE Connector (J21, 39-pin block).....</i>	23
3.5.2	<i>Secondary IDE Connector (J18, 39-pin block) .....</i>	23
3.5.3	<i>Floppy Drive Connector (J23, 33-pin block) .....</i>	24
3.5.4	<i>Power Input Connector (J20, 20-pin block).....</i>	24
3.5.5	<i>Front Panel connectors.....</i>	25
3.5.6	<i>Back Panel Connectors.....</i>	27
	<i>Additional Connectors.....</i>	30
4	BIOS SETUP .....	36
4.1	HOW TO ENTER BIOS SETUP .....	36
4.1.1	<i>Setup Keys.....</i>	37
4.1.2	<i>Getting Help.....</i>	37
4.1.3	<i>In Case of Problems.....</i>	37

# CONTENTS

4.2	MAIN SETUP MENU.....	38
4.3	STANDARD CMOS SETUP MENU.....	40
4.4	BIOS FEATURES SETUP MENU .....	44
4.5	CHIPSET FEATURES SETUP MENU.....	47
4.6	POWER MANAGEMENT SETUP MENU.....	49
4.7	PCI CONFIGURATION SETUP MENU.....	52
4.8	INTEGRATED PERIPHERALS MENU .....	53
4.9	LOAD SETUP DEFAULTS .....	56
4.10	USER PASSWORD .....	56
4.11	IDE HDD AUTO DETECTION .....	56
4.12	SAVE & EXIT SETUP .....	56
4.13	EXIT WITHOUT SAVING .....	57

# 1. INTRODUCTION

## 1 INTRODUCTION



### How To Use This Manual

This manual provides information necessary for Original Equipment Manufactures (OEMs) and home users to build a PC-AT compatible system using the Pentium II PCI/ISA/AGP motherboard. Just follow the installation procedure presented on the **EASY**

**INSTALLATION Page** and refer to the section number following each step if you require more detailed instructions.

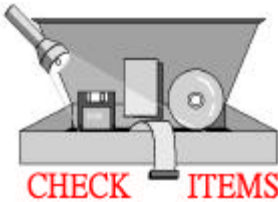

### Check Your Device Items

The standard package should contain following items marked with a “✓”. If you find any these items missing or damaged. Please contact your retailer.

- ✓The GT440ZX motherboard
- ✓Universal Retention Mechanism ( Support both Pentium II & Celeron CPU)
- ✓1 IDE ribbon cable
- ✓1 floppy ribbon cable
- ✓1 CD with drivers of Audio and PIIX4E Bus Master.

## **2. FEATURES**

# **2 FEATURES**

**Photo Of The Motherboard**

## 2. FEATURES



### Features Of The Motherboard

The GT440ZX motherboard integrates the Pentium II<sup>®</sup> microprocessor, memory, I/O and AGP, and is designed to fit into a Micro ATX form factor chassis. Page 14 illustrates the Layout for the GT440ZX motherboard. Below lists the key features provided by this motherboard:

#### Processor (+Cache)

- Single Slot-1 for Intel Pentium II Processor.
- Intel Pentium II CPU with built-in 512K/128K/0K L2 Cache.
- Support Pentium II, Celeron processor speeds (233-500MHz)

#### Chipset

- Intel 440ZX, PIIX4E Chipset
- Winbond W83977EF super I/O Controller.
- Creative Lab. ES1373 PCI 3D Audio Chip, AC97 Codec.

#### System Memory

- Two 168-pin DIMM sockets
- Minimum 8MB up to maximum 256 MB Memory Capacity.
- 66MHz / 100MHz SDRAM DIMM module.

#### PCI Bus Master IDE Controller

- Integrated PCI Bus Master IDE Controller Chip with Ultra-DMA33 capabilities. Up to four IDE devices can be supported using the two onboard IDE connectors. Also supported is PIO Modes 3&4, Bus Master IDE DMA Mode 2 and Enhanced IDE devices such as Tape Backup machines and CD-ROMs. Either the 5.25-inch or 3.5 inch (1.44MB or 2.88MB) floppy drives can be used without requiring an external card. Additionally, Floppy 3 mode (Japanese standard 3.5 inch disk drive, 1.2MB) and LS-120 floppy disk drives (3.5 inch disk drive: 120MB, 1.44MB, 720K) are also supported.

#### Integrated I/O

- 1 Floppy Port (up to 2.88 MB), 1 Parallel Port (ECP/EPP).
- 2 Serial Ports (16C550 Fast UART Compatible).
- 1 IrDA TX/RX Port. (option, shared with COM2)
- 1 PS/2 Mouse Connector, 1 PS/2 Keyboard connector.
- 2 Standard USB Connector (48MHz).

#### System BIOS

- 2MB with bootblock flash BIOS. Award PCI BIOS.
- PC97 and PnP compatible. ACPI, APM and DMI support.
- Bootable from CD-ROM supported.

#### Green Features

- Power Management: APM 1.2.

## 2. FEATURES

- Additionally, with support for ACPI (Advanced Configuration and Power Interface) feature and On-Now, your system will become more wise in management of power.

### Sound System

- Creative Lab. ES1373 PCI 3D Audio Chip, AC97 Codec.
- 3 Audio Phone Jacks (Line out, Line in, Mic. In)
- 1 MIDI/Game port, 1 CD in, 1 Modem in. 1 Aux in.
- SPDIF Interface support.

### Additional features

- Wake-On-LAN header
- Keyboard power on function
- Modem Ring up function
- Front USB header (optional)
- Hardware Monitor Capability (optional)

### Expansion Slots

- 1 AGP, 1 ISA, 2 PCI expansion slots and one shared PCI.

### Mechanical

- This motherboard complies with the Micro ATX Form Factor specifications and is a four layers with dimensions of 9.6" x 8".

# 3.INSTALLATION

## 3 INSTALLATION

### Motherboard Layout & Main Parts

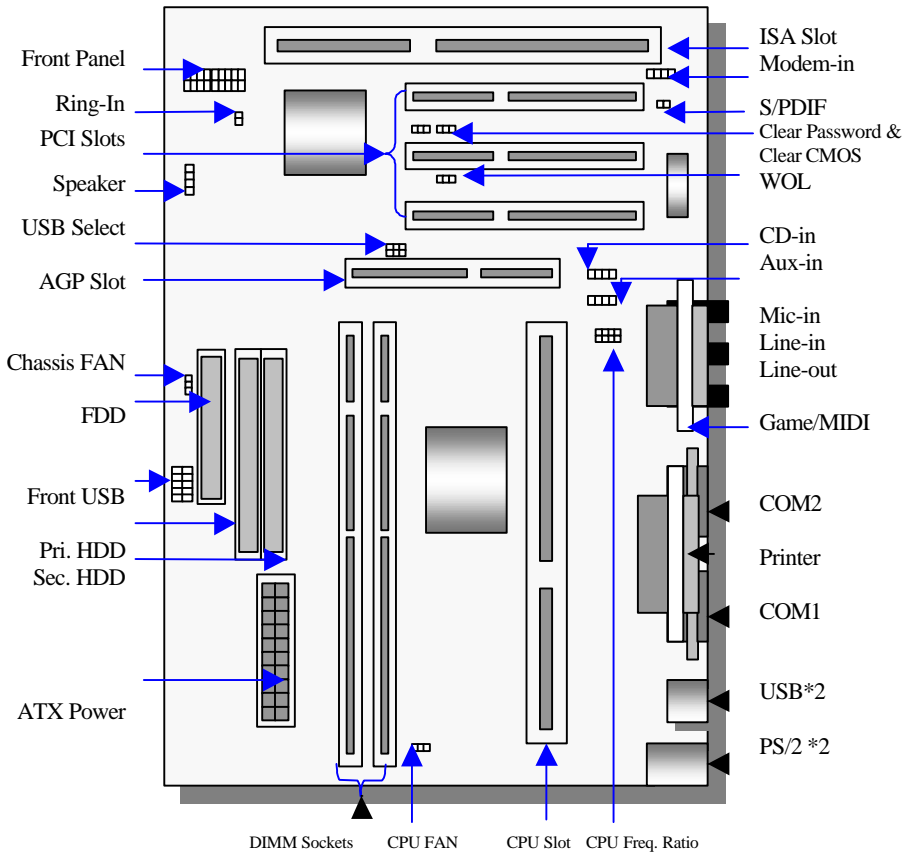

# 3.INSTALLATION

## Significant Parts List

### Front Panel Connectors

Power Switch	Sec. 3.5.5
Power LED	Sec. 3.5.5
Speaker	Sec. 3.5.5
Reset	Sec. 3.5.5
Sleep	Sec. 3.5.5
HDD LED	Sec. 3.5.5

### Back Panel Connectors

PS/2-style keyboard and mouse connectors	Sec. 3.5.6
USB connectors	Sec. 3.5.6
Two serials ports	Sec. 3.5.6
One parallel port	Sec. 3.5.6
One Game Port	Sec. 3.5.6
Line-out	Sec. 3.5.6
Line-in	Sec. 3.5.6
MIC-in	Sec. 3.5.6

### Expansion Slots/Sockets

SEC CPU Slot	Sec. 3.2
DIMM Sockets	Sec. 3.3
ISA/PCI/AGP Slots	Sec. 3.4

### Power/IDE/FDD Connectors

IDE connectors	Sec. 3.5.1
Power connector	Sec. 3.5.4
FDD connector	Sec. 3.5.3

### Additional Connectors

Chassis Fan	Sec. 3.5.7
Clear Password	Sec. 3.5.7
Clear CMOS	Sec. 3.5.7
IrDA	Sec. 3.5.7
CPU Fan	Sec. 3.5.7
Modem-IN	Sec. 3.5.7
WOL Connector	Sec. 3.5.7
SB-LINK	Sec. 3.5.7
CD-IN	Sec. 3.5.7
AUX-IN	Sec. 3.5.7
Front USB Header	Sec. 3.5.7

# 3.INSTALLATION

## Precaution Before Start

### Static Electricity Damage:



Static electricity can easily damage your motherboard. Observing a few basic precautions can help safeguard against damage that could result in expensive repairs. Follow the simple measures below to protect your equipment from static electricity damage:

1. Keep the motherboard and other system components in their anti-static packaging until you are ready to install them.
2. Touch a grounded surface before you remove any system component from its protective anti-static packaging. Unpacking and installation should be done on a grounded, anti-static mat. The operator should be wearing an anti-static wristband, grounded at the same points as the anti-static mat.
3. After removing the motherboard from its original packaging, only place it on a grounded, anti-static surface component side up. Immediately inspect the board for damage. Due to shifting during shipping, it is suggested that the installer press down on the entire socket ICs to ensure they are properly seated. Do this only with the board placed on a firm flat surface.
4. During configuration and installation touch a grounded surface frequently to discharge any static electrical charge that may have built up in your body. The best precaution is to wear a grounded wrist strap. When handling the motherboard or an adapter card avoids touching its components. Handle the motherboard and adapter cards either by the edges or by the adapter card case-mounting bracket.

### Misplaced Jumper Damage:



There are critical headers used for connectors or power sources. These are clearly marked separately from the jumpers listed in Motherboard Layout. Incorrectly setting jumpers and connectors may lead to damage to your motherboard. Please pay special attention not to connect these headers in wrong directions.

# 3.INSTALLATION

## 3.1 Slots And Connectors

This motherboard requires jumper setting for CPU speed. Please refer to Jumper setting List in sec.3.2.2.

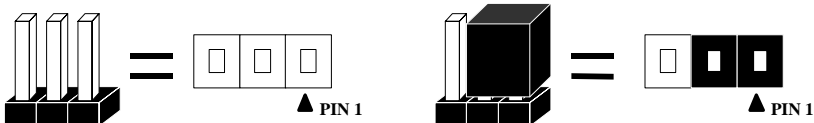

In following pages, the triangle ▲ mark stands for pin 1 of connectors.

### Slots/Connectors List

J1: Keyboard / Mouse	J2: USB1 / USB2
J3: COM2	J4: COM1
J5: Line-in, Line-out and Mic-in	J6: Game / MIDI
J7: Printer	J8: MODEM-In
J9: SPDIF	J10: CD-IN
J11: PCI 3	J12: PCI 2
J13: PCI 1	J14: Front USB Header
J15: AGP Slot	J16: WOL (Wake On LAN)
J17: CPU Fan Header	J18: Secondary IDE
J19: Ring-IN	J20: ATX-Power
J21: Primary IDE	J22: Front Panel headers
J23: Floppy	J24: Speaker
J25: Chassis Fan	J26: AUX-IN
JP1: CPU Speed Jumper	
JP2: Clear CMOS jumper	
JP3: Clear Password	
JP4&JP5: USB select (Reserved)	

# 3.INSTALLATION

## 3.2 CPU (Central Processing Unit)

This motherboard provides a Single Edge Contact (SEC) slot and a Bridges on the board for the Pentium II processor packaged in a SEC cartridge. This cartridge includes the processor core, second-level cache, thermal plate and black cover. When mounted in Slot1, the processor is secured by two retention mechanism attached to the motherboard.

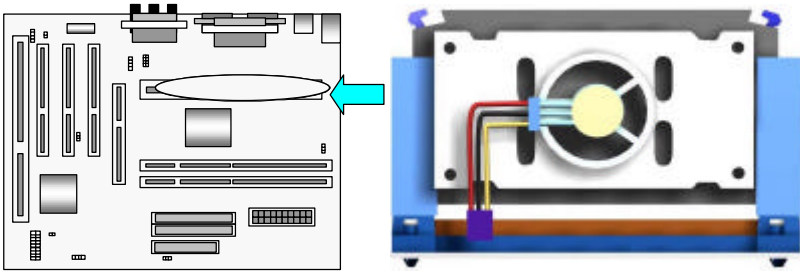

### 3.2.1 Install CPU

Please follow the below steps to install your CPU, and configure the speed in according to Processor Jumper Setting List.

First please ensure the following parts you received with this motherboard. One Pentium II URM (Universal Retention Mechanism) and four Lock Pins. Usually, the URM was set on motherboard already.

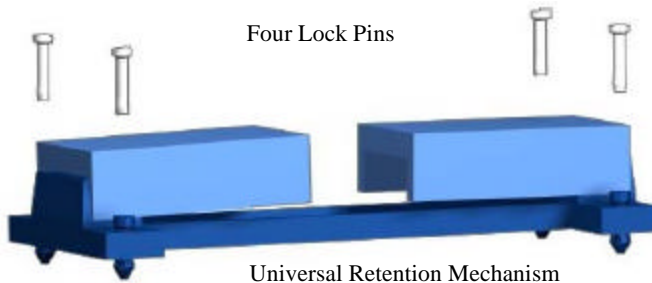

# 3.INSTALLATION

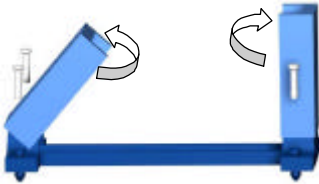

1. Unfold the Retention Mechanism.

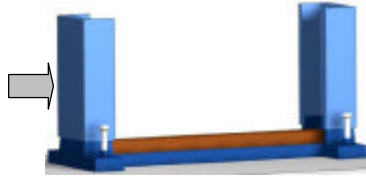

2. Place the Retention Mechanism over CPU Slot.

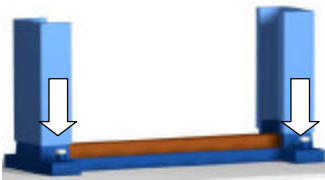

3. Push 4 lock pins into holes to fix Retention Mechanism on motherboard.

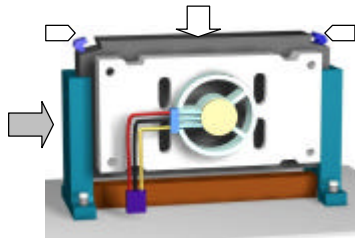

4. Insert CPU. Push the two lock pins inward and press CPU down gently.

Step 1: Place the Universal Retention Mechanisms over the CPU slot (SEC slot) on motherboard.

Step2: Fix the Retention Mechanism to the motherboard with four Lock Pins. To insert the Lock Pins into holes to lock them tight and firmly. And then unfold the URM.

Step 3: Push the SEC Cartridge's two locks inward and insert the CPU into Retention Mechanism. Press the top of CPU gently but firmly until it is fully inserted.

Warning : It is strongly recommended that a heatsink and CPU cooling fan be used to prevent the CPU from overheating. Applying a thermal of jelly between the

# 3.INSTALLATION

CPU and the heatsink/fan will further cool the CPU.

## 3.2.2 Set CPU Speed

For different CPU frequency ratio, you have to configure the jumper settings for your CPU. Please refer to the following figure and tables to carefully finish it.

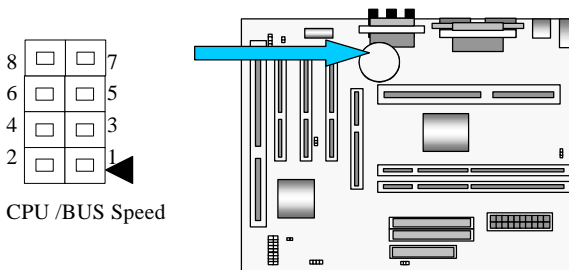





















Now follow the below table to configure your CPU settings.  
Setting CPU/BUS Speed

Intel CPU/BUS	JP1			
	Pin 1&2	Pin 3&4	Pin 5&6	Pin 7&8
X3.5 (233/66 MHz)	<input type="checkbox"/> <input type="checkbox"/>	<input checked="" type="checkbox"/> <input checked="" type="checkbox"/>	<input type="checkbox"/> <input type="checkbox"/>	<input checked="" type="checkbox"/> <input checked="" type="checkbox"/>
X4 (266/66 MHz)	<input checked="" type="checkbox"/> <input checked="" type="checkbox"/>	<input type="checkbox"/> <input type="checkbox"/>	<input checked="" type="checkbox"/> <input checked="" type="checkbox"/>	<input checked="" type="checkbox"/> <input checked="" type="checkbox"/>
X4.5 (300/66 MHz)	<input checked="" type="checkbox"/> <input checked="" type="checkbox"/>	<input type="checkbox"/> <input type="checkbox"/>	<input type="checkbox"/> <input type="checkbox"/>	<input checked="" type="checkbox"/> <input checked="" type="checkbox"/>
X5 (333/66 MHz)	<input type="checkbox"/> <input type="checkbox"/>	<input type="checkbox"/> <input type="checkbox"/>	<input checked="" type="checkbox"/> <input checked="" type="checkbox"/>	<input checked="" type="checkbox"/> <input checked="" type="checkbox"/>
X5.5 (366/66 MHz)	<input type="checkbox"/> <input type="checkbox"/>	<input type="checkbox"/> <input type="checkbox"/>	<input type="checkbox"/> <input type="checkbox"/>	<input checked="" type="checkbox"/> <input checked="" type="checkbox"/>
X6 (400/66 MHz)	<input checked="" type="checkbox"/> <input checked="" type="checkbox"/>	<input checked="" type="checkbox"/> <input checked="" type="checkbox"/>	<input checked="" type="checkbox"/> <input checked="" type="checkbox"/>	<input type="checkbox"/> <input type="checkbox"/>
X6.5 (433/66 MHz)	<input checked="" type="checkbox"/> <input checked="" type="checkbox"/>	<input checked="" type="checkbox"/> <input checked="" type="checkbox"/>	<input type="checkbox"/> <input type="checkbox"/>	<input type="checkbox"/> <input type="checkbox"/>

# 3.INSTALLATION

X7 (466/66 MHz)				
--------------------	---	---	---	---

Intel CPU/BUS	JP1			
	Pin 1&2	Pin 3&4	Pin 5&6	Pin 7&8
X3 (300/100 MHz)				
X3.5 (350/100 MHz)				
X4 (400/100 MHz)				
X4.5 (450/100 MHz)				
X5 (500/100 MHz)				

Note: Host Bus Frequency (66 MHz or 100 MHz) will be auto-detected by this motherboard.

# 3.INSTALLATION

## 3.3 System Memory (DRAM)

### 3.3.1 DIMM (Dual Inline Memory Module)

The GT440ZX features two 168-pin DIMM sockets. You can configure the system memory size from 8MB to 256MB in a variety of ways by using different combinations of the three 168-pin DIMM. Note that you must use only PC/100-compliant DIMMs if the CPU Host frequency was set in 100 MHz.

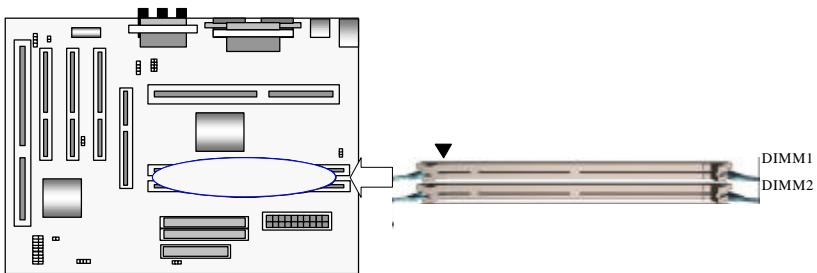

### 3.3.2 Installation Procedure

**Step1:** Pin 1 of the DIMM must match pin 1 of the DIMM socket.

**Step2:** Insert the DIMM module into the DIMM socket vertically. After inserting the DIMM module completely into the socket, push up on the socket latches securing the DIMM into place.

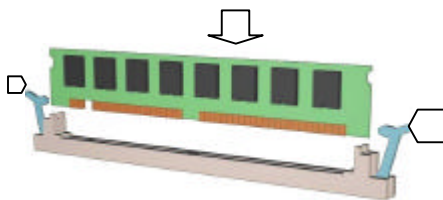

If pin 1 of the DIMM module does not line up with pin 1 of the socket, the DIMM module will not be inserted correctly into the socket.

Be careful not to misfit the DIMM Module into DIMM sockets in wrong direction. This module can be inserted into DIMM socket only one way. Please note the “▲” for pin 1 location. To release the memory module, push both latches down and carefully rock the module forward and backward while slowly lifting it upward.

# 3.INSTALLATION

## 3.3.3 DIMM Module Combinations

Each DIMM socket can be inserted with 8MB, 16MB, 32MB, 64MB, 128MB DIMM or empty. The total combinations are,6\*6 selections. You can refer to following figure to select one way to insert your DIMM, for example:

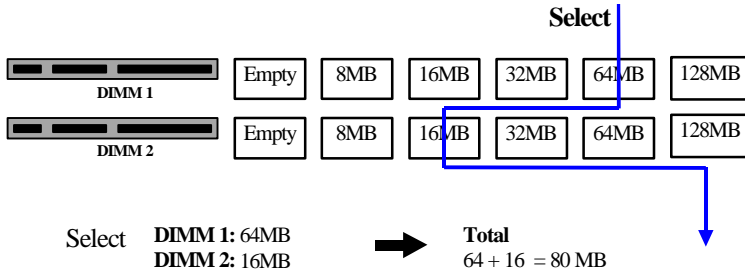

To select 1 out of 6 items (empty, 8MB, 16MB, 32MB, 64MB, 128MB) in DIMM1. Then, repeat again in DIMM2 to go through your own path.

**A total of 36 combinations ensure you can insert your DIMM modules any way you prefer.**

# 3.INSTALLATION

## 3.4 Expansion Slots

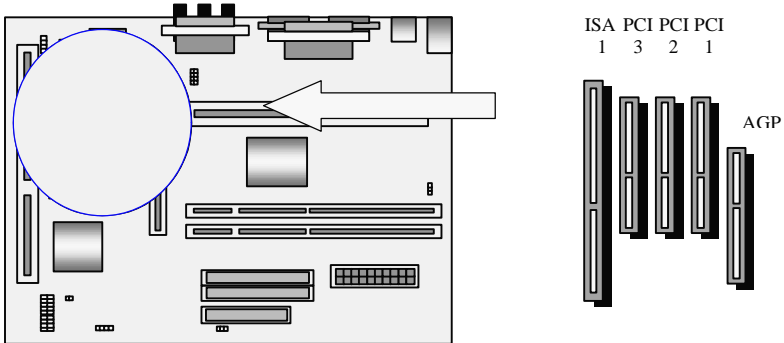

This motherboard contains 5 expansion slots onboard. One 16-bit ISA Bus, Three 32-bit PCI expansion slots and one 32-bit AGP slot as shown above.

All three PCI expansion slots accept PCI us master cards and are fully supported by the PCI 2.1 specification.

The Accelerated Graphics Port (AGP or A.G.P.) is a high performance interconnect targeted at 3D graphical display applications and is based on a set of performance extensions or enhancements to the PCI bus. (AGP interface specification Rev. 1.0 compliant)

To install expansion cards, please read the expansion card's documentation for instructions and cautions.

# 3.INSTALLATION

## 3.5 Connectors

This GT440ZX motherboard contains IDE, floppy, power input, front panel, back panel and additional connectors.

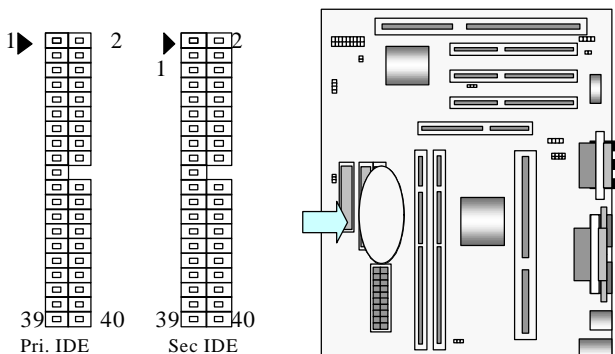

### 3.5.1 Primary IDE Connector (J21, 39-pin block)

This connector supports two primary channel IDE devices via a ribbon cable. When two IDE devices are installed using the primary IDE connector, make sure that the second IDE device is set to slave mode as indicated in the device's manual.

### 3.5.2 Secondary IDE Connector (J18, 39-pin block)

This connector supports two secondary channel IDE devices as well as the 120MB Floppy drives via a ribbon cable. When two IDE devices are installed using the secondary IDE connector, make sure that the second IDE device is adjusted to slave mode as instructed in the device's manual.

**WARNING:** When you connect a ribbon cable to these ports, you must orient the cable connector so that the PIN 1 edge of the cable is at the PIN 1 edge of the onboard connector.

# 3.INSTALLATION

## 3.5.3 Floppy Drive Connector (J23, 33-pin block)

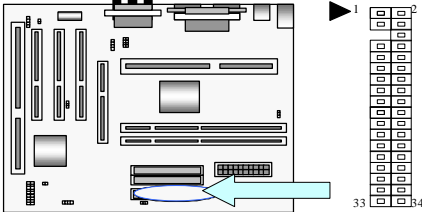

The FDC sub-system can control three types of floppy drives (1.2, 1.44 and 2.88MB) or compatible tape drives. The connection to the floppy drive is via a header (J19). The floppy disk interface includes 48mA drivers and inputs on the drive interface.

## 3.5.4 Power Input Connector (J20, 20-pin block)

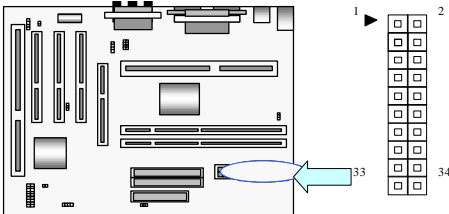

This connector supports a Micro ATX power supply. When connecting, make sure the lock key matches the hook attached on a power supply cable. The power cord should be unplugged when you connect it.

# 3.INSTALLATION

## 3.5.5 Front Panel connectors

Front Panel includes headers for the following six I/O connectors:  
Power Switch, Power LED, Speaker, Reset, Sleep and HDD LED.

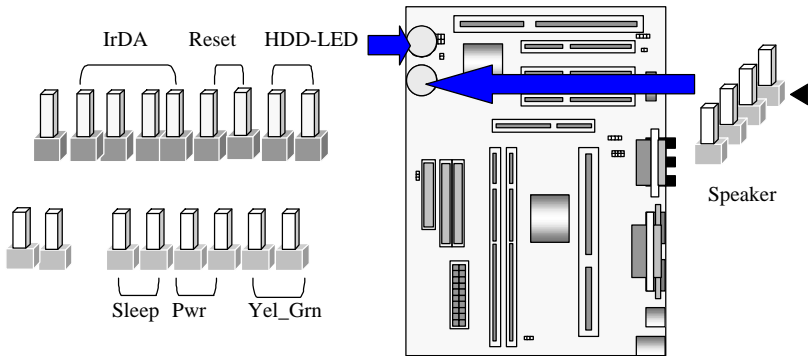

### Infrared (IrDA) connector (4-pin)

The GT440ZX offers an IrDA infrared header that supports third party infrared modules. The case must reserve space for the IR module if you want to use the IrDA function. This option supports wireless transmission and reception of infrared data. The module mounts in a small opening on the system case that supports this feature. The efficient distance is 100cm and the transfer rate is 115,200 bits/sec.

### Reset Switch Connector (2-pin)

This connector supports the front panel case-mounted reset button. It is advised that the reset switch be used for rebooting the system in order to extend the life of the system's power supply.

### HDD ( IDE ) LED Connector (2-pin)

The GT440ZX supports one straight 4-pin header for connecting to front Panel Hard Disk activity LED indicator.

### Sleep Switch (2-pin)

When the APM (Advanced Power Management) feature is enabled in the system

# 3.INSTALLATION

BIOS and the operating system's APM driver is loaded, the system can enter the sleep (standby) mode in one of the following ways:

- ◆ Optional front panel sleep/resume button
- ◆ Prolonged system inactivity using the BIOS inactivity timer feature (Section 4.5)

The 2-pin header supports a front panel sleep/resume switch, which must be a momentary SPST type that is normally open

## **Power Switch (2-pin)**

This connector supports the ATX case-mounted Power Switch, which in turn supports System Suspend function. When the BIOS sets the Power Button function to "Delay 4 sec.", the system can be set to the suspended mode once you push the power switch for no longer than 4 seconds. If the power switch is pushed down for over 4 seconds the system will be totally Power Off. When the BIOS setting sets the Delay 4 second to "Instant-off", then Power Switch function work as regular power switch.

## **Power LED (2-pin)**

This header can be connected to a LED that will light when the computer is powered on.

## **Speaker Connector (4-pin)**

It is used to drive a chassis-mounted speaker if desired.

# 3.INSTALLATION

## 3.5.6 Back Panel Connectors

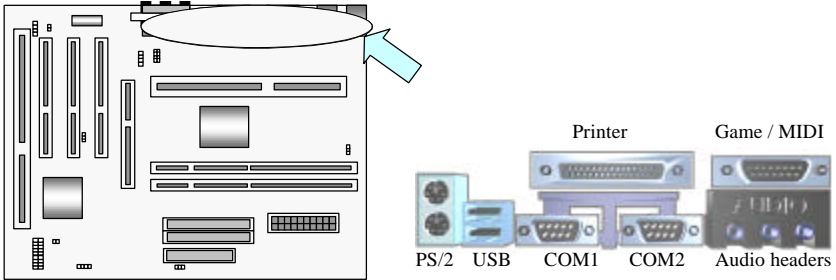

### PS/2 Keyboard and Mouse Ports (J1)

The motherboard offers 1 PS/2 Keyboard and 1 PS/2 Mouse port.

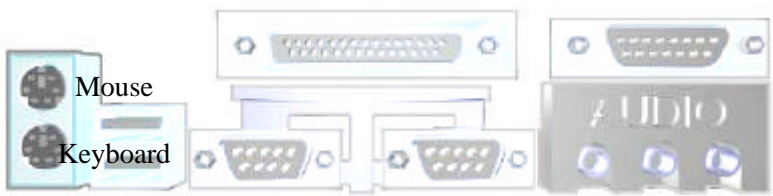

### Universal Serial Bus (USB) Ports (J2)

The motherboard has two USB connectors. USB devices provide a more convenient operating environment and improve data transferring capacity. True Plug & Play, this new bus technology will support over 127 different peripherals through a Hub.

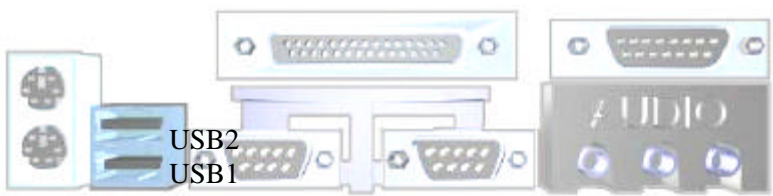

# 3.INSTALLATION

## Parallel Port (Printer, J7)

The GT440ZX includes a parallel port (EPP/ECP compatible). The parallel port is capable of being disabled or remapped to either the secondary LPT address or the primary LPT address through BIOS if another parallel port is installed.

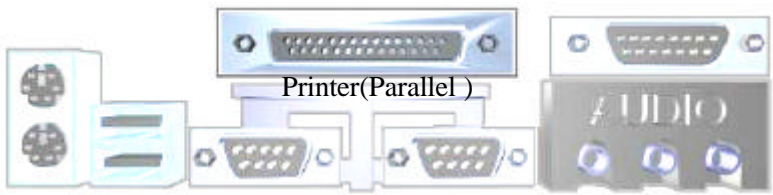

## Serial Port (COM, J4&J3)

The motherboard has two serial ports. The electrical characteristics are compliant with the EIA-232-D Serial Communications Specifications. The serial ports may be remapped over other installable serial ports or disabled through the BIOS.

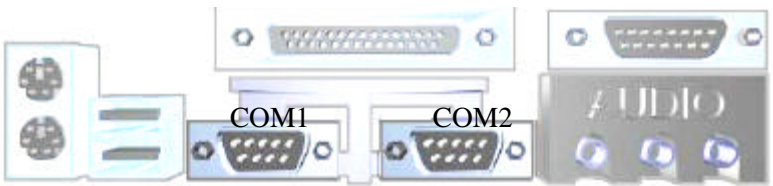

# 3.INSTALLATION

## GAME / MIDI Port (J6)

The GT440ZX integrate a Game/MIDI port. This port can let you plug a joystick or MIDI device.

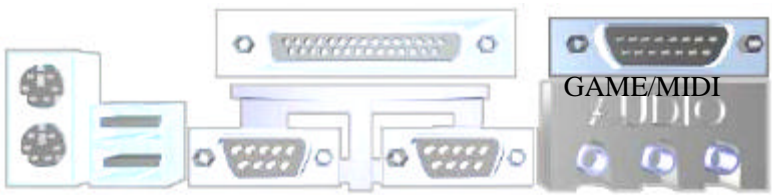

## Audio Port ( Line-in, Line-out, MIC-in) (J5)

The GT440ZX also provides external sound system through a user accessible stereo jack connector soldered to the PWA.This jack allow the connection of self-amplified speakers, Line-in voice input and MIC-in voice input.

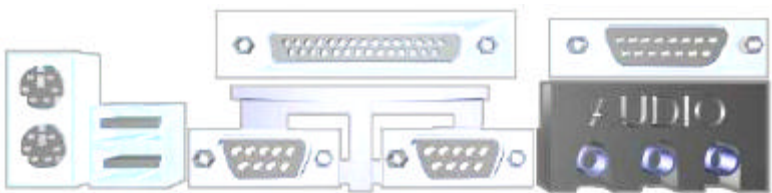

Line-out Line-in Mic-in

# 3.INSTALLATION

## 3.5.7 Additional Connectors

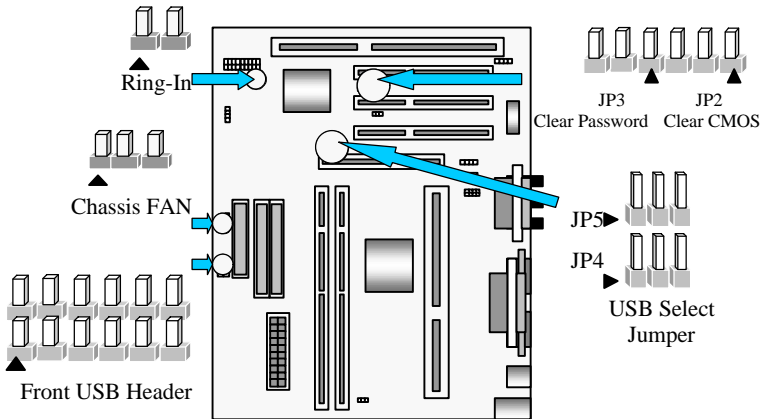

### Ring In (J19, 2-pin)

This header is used for remote wakeup of the computer through a modem. Ring-In requires an add-in modem card with remote wakeup capabilities. The remote wakeup header on the add-in modem card must be connected to the onboard Ring-In header.

### Clear Password (JP3, 2-pin)

If an unknown password is set in the BIOS, it can be cleared by inserting a cap over pin 1&2 of the "Clear Password" header.

### Clear CMOS (JP2, 2-pin)

You can insert a cap over pin 1&2 of the "Clear CMOS" header to clear the CMOS data and reload the default settings.

### Chassis Fan (J25, 3-pin)





This header can supply power for Chassis Fan which may be mounted inside your case to cool down your system components. If your chassis have a Chassis Fan, this header will support.

# 3.INSTALLATION

## Front USB Header (J14, 10-pin)

You can use either this Front USB or Back Panel USB by setting the USB Select jumper. Following table shows the jumper settings.

**USB Select Jumper**

USB Select	Front USB	Back USB
JP4		
JP5		

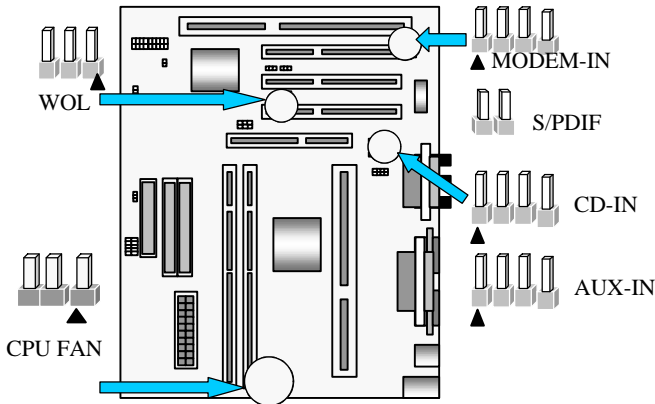

## WOL (Wake On LAN ) (J16, 3-pin)

This header is used for remote wakeup of the computer through a network. WOL requires a PCI add-in network interface card (NIC) with remote wakeup capabilities. The remote wakeup header on the NIC must be connected to the onboard Wake on LAN header. For Wake on LAN, the 5-V standby line for the power supply must be capable of delivering 5V±5% at 720mA.

## CPU Fan (J17, 3-pin)

Your Pentium Cartridge may have an attached heatsink and Fan; this connector is for the CPU Fan.

## 3.INSTALLATION

### **MODEM-IN Header (J8, 4-pin, Green)**

A 1x4 pin ATAPI style connector (J2F1) is available for connecting the monaural audio signals of an internal telephony device to the audio subsystem. A monaural audio-in and audio-out signal interface is necessary for telephony applications such as speakerphones, fax modems, and answering machines..

### **S/PDIF(J9, 2-pin)**

This connector is the digital link between the motherboard and your audio devices such as CD player, or DAT recorder. It allows the digital transmission of audio data in SPDIF (Sony/Philips Digital Interface) Format.

### **CD-IN Header (J10, 4-pin, Black)**

A connector is available for audio input from CD-ROM drives.

### **AUX-IN Header (J26, 4-pin, White)**

Access to the AUX-IN connector for audio input from AUX devices.

# 3.INSTALLATION

## Ready To Turn On Power

### ◆ Check Again



1. Is the CPU installed exactly and firmly into socket (Sec. 3.2)?
2. Are all the DRAM modules installed properly (Sec. 3.3)?
3. Did you insert expansion card (VGA, Sound.... etc.) already (Sec. 3.4)?
4. Are you sure that all the connectors (described in Sec 3.5) have been connected to their variable devices (Sec. 3.5)?

### ◆ Yes, I have checked and assured the above steps!



Now get ready to turn on your device by the following steps.

1. Mount your motherboard to the chassis frame and close the case cover.
2. Switch off all power.
3. Connect the power supply cord into inlet of the system case.
4. Connect the power supply cord into an outlet of power supply.
5. Connect Monitor signal cable to system VGA port, and the monitor power cord to power outlet.
6. Now turn on monitor and system power.

**After Power on**, The power LED on the front panel of the system case will light. For ATX power supplies, the system LED will light when the ATX power switch is pressed.

The system will then do a power-on tests item by item, and additional messages will appear on screen. If the screen blinks or the tests stops more than 30 seconds, the system may have failed the power-on test. If so, please recheck the above steps or call your retailer for assistance.

If the power-on test goes well, hold down <Delete> button on the keyboard to enter BIOS Setup. Next, follow the instructions in the next chapter, **BIOS**



# 3.INSTALLATION

**SETUP.**

# 3.INSTALLATION

## 4. BIOS SETUP

# 4 BIOS SETUP



The GT440ZX motherboard uses AWARD BIOS, which is stored in a Flash EEPROM and can be upgraded by a floppy disk-based program. The BIOS has a built-in Setup Program that allows users to modify the basic system configuration settings. The settings are then stored in a dedicated battery-backed memory, called CMOS RAM that retains the information when the power is turned off. The BIOS provides

critical low-level support for the system's central processing, memory and I/O subsystems. The AWARD BIOS has been customized by adding important, nonstandard, features such as virus and password protection, power management, and detailed fine-tuning of the chipset which controls the system. The remainder of this manual is intended to guide you through the process of configuring your system using the BIOS Setup.

### 4.1 How To Enter BIOS Setup

The AWARD BIOS is immediately activated when you first turn on the computer. The BIOS reads system configuration information in CMOS RAM and begins the process of checking the system and configuring it through the power-on self test (POST). When these preliminaries are finished, the BIOS seek an operation system on the data storage devices (hard drive, floppy drive, etc.). The BIOS launches the operating system and hands over control of system operation to it.

To start Setup, press the <Del> key during boot-up before or while a message similar to this appears briefly at the bottom of the screen during POST (Power On Self Test):

#### **Press DEL if you want to enter SETUP**

If the above message disappears before you have responded and you still wish to enter Setup, reboot the system to try again by pressing the "RESET" button on the system case. You may also restart by simultaneously pressing the <Ctrl>, <Alt> and <Delete> keys.

Press **F1** to continue, **DEL** to enter SETUP

## 4. BIOS SETUP

### 4.1.1 Setup Keys

These keys help you navigate in Setup:

<↑>, <↓>	Move to previous or next item
<<->, <->>	Move to the item in the left or right hand
<Esc>	Main Menu – Quit and not save changes into CMOS Other Pages -- Exit current page and return to Main Menu
<PgUp> / <+>	Increase the numeric value or make changes
<PgDn> / <->	Decrease the numeric value or make changes
<F1>	General help, only for Status Page Setup Menu and Option Page Setup Menu
<F2>	Change color from total 16 colors. F2 to select Shift-F2 color forward, Shift-F2 to select color backward
<F3>	<b>Calendar, only for Status Page Setup Menu</b>
<F5>	Restore the previous CMOS value from CMOS, only for Option Page Setup Menu
<F7>	Load the Setup default
<F10>	Save all the CMOS changes, only for Main Menu

### 4.1.2 Getting Help

Press F1 to pop up a small help window that describes the appropriate keys to use and the possible selections for the highlighted item. To exit the Help Window press Esc or the F1 key again.

### 4.1.3 In Case of Problems

If after making and saving system changes with Setup, you discover that your computer no longer is able to boot, the Award BIOS supports an override to the CMOS settings that resets your system to its default configuration.

The best advice is to alter only settings that you thoroughly understand. In particular, do not change settings in the Chipset screen without a good reason. Your system manufacturer for the best performance and reliability has carefully chosen the Chipset defaults. Even a seemingly small change to the Chipset setup may cause the system to become unstable.

# 4. BIOS SETUP

## 4.2 Main Setup Menu

When you enter the Award BIOS CMOS Setup Utility, a Main Menu (Figure 1) appears on the screen. The Main Menu allows you to select from several Setup functions and two exit choices. Use the arrow keys to select among the items and press Enter to accept and enter the sub-menu.

A brief description of each highlighted selection appears at the bottom of the screen.

ROM PCI/ISA BIOS (2A69KB3M) CMOS SETUP UTILITY AWARD SOFTWARE, INC.	
<b>STANDARD CMOS SETUP</b> BIOS FEATURES SETUP CHIPSET FEATURES SETUP POWER MANAGEMENT SETUP PNP/PCI CONFIGURATION LOAD SETUPDEFAULTS	INTEGRATED PERIPHERALS USER PASSWORD IDE HDD AUTO DETECTION SAVE & EXIT SETUP EXIT WITHOUT SAVING
Esc : Quit	↑→←↓ : Select Item
F10 : Save & Exit Setup	(Shift) F2 : Change Color
Time, Date, Hard Disk Type	

**Figure 1: Main Menu**

## 4. BIOS SETUP

Following is a brief summary of each Setup category.

Standard CMOS	Options in the original PC AT-compatible BIOS.
BIOS Features	Award enhanced BIOS options.
Chipset Features	Options specific to your system chipset.
Power Management	Advanced Power Management (APM) options.
PnP/PCI Configuration	Plug and Play standard and PCI Local Bus configuration options.
Integrated Peripherals	I/O subsystems that depend on the integrated peripherals controller in your system.
Supervisor/User Password Setting	Change, set, or disable a password. In BIOS versions that allow separate user and supervisor passwords, only the supervisor password permits access to Setup. The user password generally allows only power-on access.
IDE HDD Auto Detection	Automatically detect and configure IDE hard disk parameters.
Load Setup Defaults	Setup defaults are factory settings for optimal-performance system operations.
Save & Exit Setup	Save settings in nonvolatile CMOS RAM and exit Setup.
Exit Without Save	Abandon all changes and exit Setup.

## 4. BIOS SETUP

### 4.3 Standard CMOS Setup Menu

In the Standard CMOS Menu (Figure2) you can set the system clock and calendar, record disk drive parameters and the video subsystem type, and select the type of errors that stop the BIOS POST.

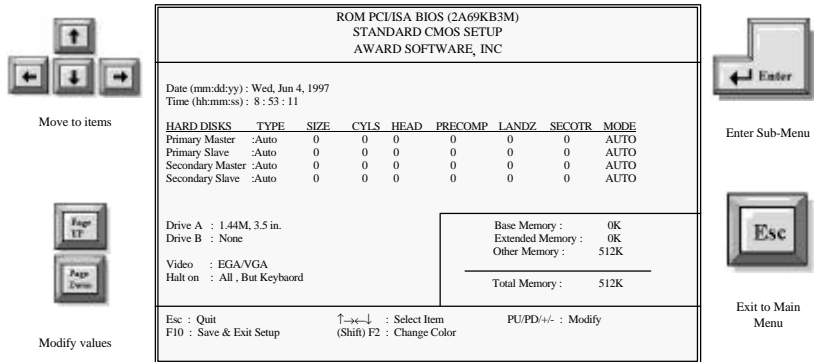

Figure 2: Standard CMOS setup

#### Date

The BIOS determines the day of the week from the other date information. This field is for information only. Press the left or right arrow key to move to the desired field (date, month, year). Press the PgUp or PgDn key to increment the setting, or type the desired value into the field.

#### Time

The time format is based on the 24-hour military-time clock. For example, 1 p.m. is 13:00:00. Press the left or right arrow key to move to the desired field. Press the PgUp or PgDn key to increment the setting, or type the desired value into the field.

#### Hard Disks

The BIOS supports up to four IDE drives. This section does not show information about other IDE devices, such as a CD-ROM drive, or about other hard drive types, such as SCSI drives.

## 4. BIOS SETUP

*NOTE: We recommend that you select type AUTO for all drives.*

The BIOS can automatically detect the specifications and optimal operating mode of almost all IDE hard drives. When you select type AUTO for a hard drive, the BIOS detects its specifications during POST, every time the system boots.

If you do not want to select drive type AUTO, other methods of selecting the drive type are available:

- 1) Match the specifications of your installed IDE hard drive(s) with the preprogrammed values for drive types 1 through 45.
- 2) Select USER and enter values into each drive parameter field.
- 3) Use the IDE HDD AUTO DETECTION function in Setup.

Here is a brief explanation of drive specifications:

- **Type:** The BIOS contains a table of pre-defined drive types. Each defined drive type has a specified number of cylinders, number of heads, write precompensation factor, landing zone, and number of sectors. Drives whose specifications do not accommodate any pre-defined type are classified as type USER.
- **Size:** Disk drive capacity (approximate). Note that this size is usually slightly greater than the size of a formatted disk given by a disk-checking program.
- **Cyls:** Number of cylinders
- **Head:** Number of heads
- **Precomp:** Write precompensation cylinder
- **Landz:** Landing zone
- **Sector:** Number of sectors
- **Mode:** Auto, Normal, large, or LBA
- **Auto:** The BIOS automatically determines the optimal mode.
- **Normal:** Maximum number of cylinders, heads, and sectors supported are 1024, 16, and 63.
- **Large:** For drives that do not support LBA and have more than 1024 cylinders.
- **LBA (Logical Block Addressing):** During drive accesses, the IDE controller transforms the data address described by sector, head, and cylinder number into a physical block address, significantly improving data transfer rates. For drives

## 4. BIOS SETUP

with greater than 1024 cylinders.

### Drive A/B type

Select the correct specifications for the diskette drive(s) installed in the computer.

None	No diskette drive installed
360K, 5.25 in	5-1/4 inch PC-type standard drive; 360 kilobyte capacity
1.2M, 5.25 in	5-1/4 inch AT-type high-density drive; 1.2 megabyte capacity
720K, 3.5 in	3-1/2 inch double-sided drive; 720 kilobyte capacity
1.44M, 3.5 in	3-1/2 inch double-sided drive; 1.44 megabyte capacity
2.88M, 3.5 in	3-1/2 inch double-sided drive; 2.88 megabyte capacity

### Video

Select the type of primary video subsystem in your computer. The BIOS usually detects the correct video type automatically. The BIOS supports a secondary video subsystem, but you do not select it in Setup.

EGA/VG A	Enhanced Graphics Adapter/Video Graphics Array. For EGA, VGA, SEGA, SVGA or PGA monitor adapters.
CGA 40	Color Graphics Adapter, power up in 40 column mode.
CGA 80	Color Graphics Adapter, power up in 80 column mode.
MONO	Monochrome adapter, includes high resolution monochrome adapters.

### Halt on

During the power-on self-test (POST), the computer stops if the BIOS detects a hardware error. You can tell the BIOS to ignore certain errors during POST and continue the boot-up process. These are the selections:

No errors	POST does not stop for any errors.
All errors	If the BIOS detects any non-fatal error, POST stops and prompts you to take corrective action.
All, But keyboard	POST does not stop for a keyboard error, but stops for all other errors.
All, But Diskette	POST does not stop for diskette drive errors, but stops for all other errors.
All, But Disk/Key	POST does not stop for a keyboard or disk error, but stops for all other errors.

## 4. BIOS SETUP

### **Memory**

You cannot change any values in the Memory fields; they are only for your information. The fields show the total installed random access memory (RAM) and amounts allocated to base memory, extended memory, and other (high) memory. RAM is counted in kilobytes (KB: approximately one thousand bytes) and megabytes (MB: approximately one million bytes).

RAM is the computer's working memory, where the computer stores programs and data currently being used, so they are accessible to the CPU. Modern personal computers may contain up to 64 MB, 128 MB, or more.

### **Base Memory**

Typically 640 KB. Also called conventional memory. The DOS operating system and conventional applications use this area.

### **Extended Memory**

Above the 1-MB boundary. Early IBM personal computers could not use memory above 1 MB, but current PCs and their software can use extended memory.

### **Other Memory**

Between 640 KB and 1 MB; often called High memory. DOS may load terminate-and-stay-resident (TSR) programs, such as device drivers, in this area, to free as much conventional memory as possible for applications. Lines in your CONFIG.SYS file that start with LOADHIGH load programs into high memory.

### **Total Memory**

System total memory is the sum of base memory, extended memory, and other memory.

## 4. BIOS SETUP

### 4.4 BIOS Features Setup Menu

This screen (Figure 3) contains industry-standard options additional to the core PC AT BIOS. This section describes all fields offered by Award Software in this screen. Some fields may vary from those in your Setup program. Your system board designer may omit or modify some fields.

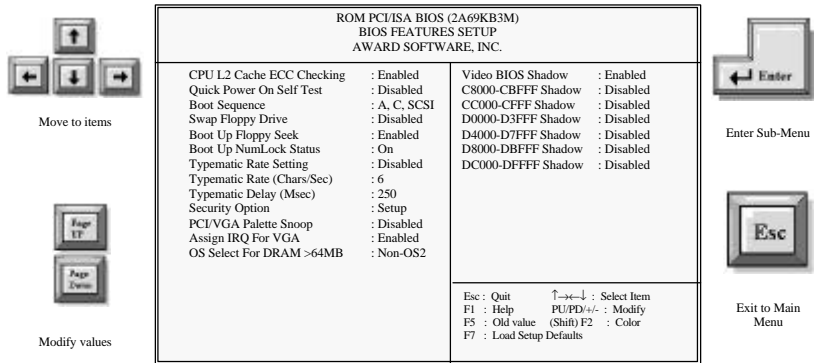

Figure 3: BIOS Features Setup Menu

#### CPU L2 Cache ECC checking

Select Enabled to allow CPU L2 Cache ECC Checking function.

#### Quick Power On Self Test

This allows you to enable or disable system self test when power on.

#### Boot Sequence

The original IBM PCs loaded the DOS operating system from drive A (floppy disk), so IBM PC-compatible systems are designed to search for an operating system first on drive A, and then on drive C (hard disk). However, the BIOS now offers 10 different boot sequence options of three drives each. In addition to the traditional drives A and C, options include IDE hard drives D, E, and F; plus a SCSI hard drive and a CD-ROM drive.

#### Swap Floppy Drive

This field is effective only in systems with two floppy drives. Selecting Enabled

## 4. BIOS SETUP

assigns physical drive B to logical drive A, and physical drive A to logical drive B.

### **Boot Up Floppy Seek**

When *Enabled*, the BIOS tests (seeks) floppy drives to determine whether they have 40 or 80 tracks. Only 360-KB floppy drives have 40 tracks; drives with 720 KB, 1.2 MB, and 1.44 MB capacity all have 80 tracks. Because very few modern PCs have 40-track floppy drives, we recommend that you set this field to *Disabled* to save time.

### **Boot Up NumLock Status**

Toggle between *On* or *Off* to control the state of the NumLock key when the system boots. When toggled *On*, the numeric keypad generates numbers instead of controlling cursor operations.

### **Typematic Rate Setting**

When *Disabled*, the following two items (Typematic Rate and Typematic Delay) are irrelevant. Keystrokes repeat at a rate determined by the keyboard controller in your system. When *Enabled*, you can select a typematic rate and typematic delay.

#### **Typematic Rate (Chars/Sec)**

When the typematic rate setting is enabled, you can select a typematic rate (the rate at which character repeats when you hold down a key) of 6, 8, 10,12, 15, 20, 24 or 30 characters per second.

#### **Typematic Delay (Msec)**

When the typematic rate setting is enabled, you can select a typematic delay (the delay before key strokes begin to repeat) of 250, 500, 750 or 1000 milliseconds.

### **Security Option**

If you have set a password, select whether the password is required every time the System boots, or only when you enter Setup.

### **PCI/VGA Palette Snoop**

Some display cards that are not standard VGA such as graphics accelerators or MPEG cards may not show the correct colors, the setting can correct this problem once you set it to Enabled, to default setting leave at Disabled.

## 4. BIOS SETUP

### Assign IRQ For VGA

Set this option to Yes to allocate an IRQ to VGA device on the PCI Bus. The setting are Enabled or Disabled.

### OS select for DRAM > 64MB

Select OS2 only if you are running OS/2 operating system with greater than 64 MB of RAM on your system.

### Shadow

Software that resides in a read-only memory (ROM) chip on a device is called *firmware*. The Award BIOS permits *shadowing* of firmware such as the system BIOS, video BIOS, and similar operating instructions that come with some expansion peripherals, such as, for example, a SCSI adaptor.

Shadowing copies firmware from ROM into system RAM, where the CPU can read it through the 16-bit or 32-bit DRAM bus. Firmware not shadowed must be read by the system through the 8-bit X-bus. Shadowing improves the performance of the system BIOS and similar ROM firmware for expansion peripherals, but it also reduces the amount of high memory (640 KB to 1 MB) available for loading device drivers, etc.

Enable shadowing into each section of memory separately. Many system designers hardwire shadowing of the system BIOS and eliminate a System BIOS Shadow option.

Video BIOS shadows into memory area C0000-C7FFF. The remaining areas shown on the BIOS Features Setup screen may be occupied by other expansion card firmware. If an expansion peripheral in your system contains ROM-based firmware, you need to know the address range the ROM occupies to shadow it into the correct area of RAM.

# 4. BIOS SETUP

## 4.5 Chipset Features Setup Menu

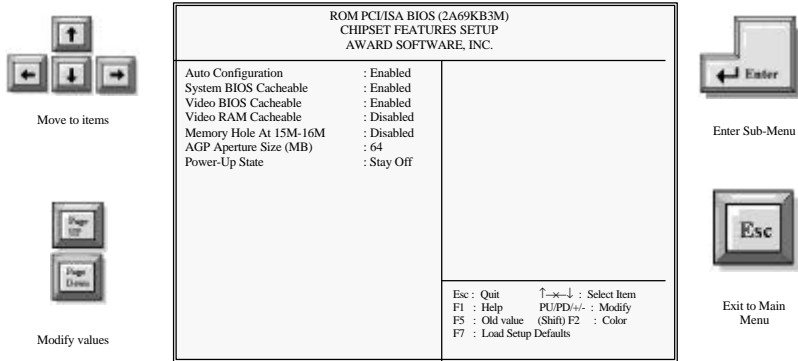

Figure 4: Chipset Features Setup Menu

### Auto Configuration

This item allows you select pre-determined optimal values for DRAM, cache, timing according to CPU type & system clock. The Choice: Enabled, Disabled.

Note: When this item is enabled, the pre-defined items will become SHOW-ONLY.

### System BIOS Cacheable

Select Enabled allows caching of the system BIOS ROM at F0000h-FFFFFh, resulting in better system performance. However, if any program writes to this memory area, a system error may result.

### Video BIOS Cacheable

Select Enabled allows caching of the Video BIOS ROM at F0000h-FFFFFh, resulting in better system performance. However, if any program writes to this memory area, a system error may result.

### Video RAM Cacheable

Select Enabled allows caching of the Video RAM, resulting in better system performance. However, if any program writes to this memory area, a system error may result.

## 4. BIOS SETUP

### **Memory Hole At 15M – 16M**

You can reserve this area of system memory for ISA adapter ROM. When this area is reserved, it cannot be cached. The user information of peripherals that need to use this area of system memory usually discusses their memory requirements.

### **AGP Aperture Size (MB)**

Select the size of the Accelerated Graphics Port (AGP) aperture. The aperture is a portion of the PCI memory address range dedicated for graphics memory address space. Those cycles that hit the aperture range are forwarded to the AGP without any translation. See [www.agpforum.org](http://www.agpforum.org) for AGP information.

### **Power-Up State**

It specifies how the computer responds following a power failure. “Stay Off” keeps power off until power button pressed. “Last State” restores previous power state before a power failure. “Power On” restores power without restoring previous power state.

# 4. BIOS SETUP

## 4.6 Power Management Setup Menu

ROM PCI/ISA BIOS (2A69KB3M) POWER MANAGEMENT SETUP AWARD SOFTWARE, INC.		
ACPI Function	: Enabled	** Reload Global Timer Events **
Power Management	: User Devine	IRQ[3-7,9-15], NMI : Disabled
PM Control by APM	: Yes	Primary IDE 0 : Disabled
Video Off Method	: V/H SYNC+Blank	Primary IDE 1 : Disabled
Video Off After	: Standby	Secondary IDE 0 : Disabled
MODEM Use IRQ	: 3	Secondary IDE 1 : Disabled
Doze Mode	: Disabled	Floppy Disk : Disabled
Standby Mode	: Disabled	Serial Port : Enabled
Suspend Mode	: Disabled	Parallel Port : Disabled
HDD Power Down	: Disabled	
PCI/VGGA Act-Monitor	: Disabled	
Soft-Off by PWR-BTTN	: Instant-Off	
CPUFAN Off In Suspend	: Enabled	
PowerOn by Ring (WOR)	: Enabled	
PowerOn by LAN (WOL)	: Enabled	
		Esc : Quit      ↑→←↓ : Select Item
		F1 : Help      PU/PD+/- : Modify
		F5 : Old value   (Shift) F2 : Color
		F7 : Load Setup Defaults

Figure 5: Power Management Setup Menu

### ACPI Function

ACPI (Advanced Configuration and Power Interface) evolves the existing motherboard configuration interfaces to support these advanced architectures in a more robust, and potentially more efficient manner.

### Power Management

This option allows you to select the type (or degree) of power saving for Doze, Standby, and Suspend modes. See the section *PM Timers* for a brief description of each mode. This table describes each power management mode:

Disable	Global Power Management will be disabled
Max Saving	Maximum power savings. <b>Only Available for SL CPUs.</b> Inactivity period is 1 minute in each mode.
User Define	Set each mode individually. Select time-out periods in the <i>PM Timers</i> section, following.
Min Saving	Minimum power savings. Inactivity period is 1 hour in each mode (except the hard drive).

### PM Control by APM

## 4. BIOS SETUP

When enabled, an Advanced Power Management device will be activated to enhance the Max. Power Saving mode and stop the CPU internal clock. If Advance Power Management (APM) is installed on your system, selecting Yes gives better power savings.

If the Max. Power Saving is not enabled, this will be preset to *No*.

### Video Off Method

Determines the manner in which the monitor is blanked.

V/H SYNC+Blank	System turns off vertical and horizontal synchronization ports and writes blanks to the video buffer.
DPMS Support	Select this option if your monitor supports the Display Power Management Signaling (DPMS) standard of the Video Electronics Standards Association (VESA). Use the software supplied for your video subsystem to select video power management values.
Blank Screen	System only writes blanks to the video buffer.

### Video Off After

As the system moves from lesser to greater power-saving modes, select the mode in which you want the monitor to blank

### Modem Use IRQ

This determines the IRQ in which the MODEM can use.

The choices: 3, 4, 5, 7, 9, 10, 11, NA.

### Doze Mode

When enabled and after the set time of system inactivity, the CPU clock will run at slower speed while all other devices still operate at full speed.

### Standby Mode

When enabled and after the set time of system inactivity, the fixed disk drive and the video would be shut off while all other devices still operate at full speed.

### Suspend Mode

When enabled and after the set time of system inactivity, all devices except the CPU will be shut off.

### HDD Power Down

When enabled and after the set time of system inactivity, the hard disk drive will be

## 4. BIOS SETUP

powered down while all other devices remain active.

### **PCI/VGA Act-Monitor**

When Enabled, this feature allows the VGA adapter to operate in a power saving mode.

### **Soft-Off by PWR-BTTN**

This item allows you to select the function of power button.

The choice: Instant-Off, Delay 4 Sec.

### **PowerOn By Ring (WOR)**

This item allows you to power on the system from Ring by selecting Enabled.

The choice: Enabled, Disabled.

### **PowerOnBy LAN(WOL)**

This item allows you to power on the system from LAN by selecting Enabled.

The choice: Enabled, Disabled.

### **\*\* Reload Global Timer Events \*\***

### **IRQ[3-7, 9-15], NMI/Primary IDE0/Primary IDE1/Floppy Disk/Serial Port/Parallel Port**

When Enabled, an event occurring on each device listed above restarts the global time for Standby mode.

## 4. BIOS SETUP

### 4.7 PCI Configuration Setup Menu

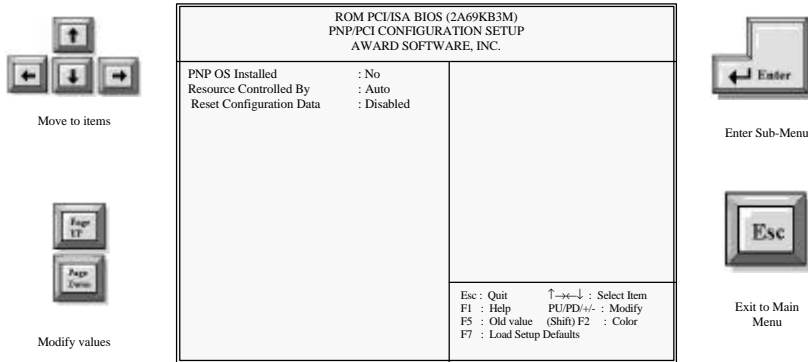

Figure 6: PNP/PCI Configuration Setup Menu

#### PNP OS Installed

This item allows you to determine install PnP OS or not.  
The choice: Yes, No.

#### Resources Controlled by

The Award Plug and Play BIOS can automatically configure all the boot and Plug and Play-compatible devices. If you select *Auto*, all the interrupt request (IRQ) and DMA assignment fields disappear, as the BIOS automatically assigns them.

#### Reset Configuration Data

Normally, you leave this field *Disabled*. Select *Enabled* to reset Extended System Configuration Data (ESCD) when you exit Setup if you have installed a new add-on and the system reconfiguration has caused such a serious conflict that the operating system cannot boot.

## 4. BIOS SETUP

### 4.8 Integrated peripherals Menu

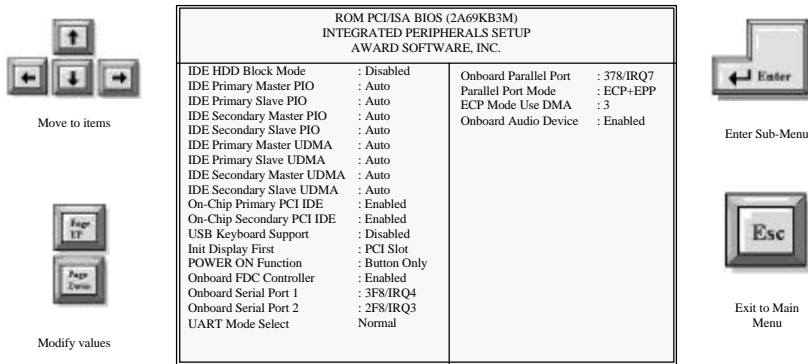

Figure 7: Integrated Peripherals setup Menu

#### IDE HDD Block

Block mode is also called block transfer, multiple commands, or multiple sector read/write. If your IDE hard drive supports block mode (most new drives do), select Enabled for automatic detection of the optimal number of block read/writes per sector the drive can support. The Choice: Enabled, Disable.

#### IDE Primary/Secondary Master/Slave PIO

The four IDE PIO (Programmed Input / Output) fields let you set a PIO mode (0-4) for each of the four IDE devices that the onboard IDE interface supports.

#### IDE Primary/Secondary Master/Slave UDMA

Ultra DMA/33 implementation is possible only if your IDE hard drive supports it and the operating environment includes a DMA driver (Windows 95 OSR2 or a third-party IDE bus master driver). If your hard drive and your system software both support Ultra DMA/33, select Auto to enable BIOS support. The Choice: Auto, Disabled

#### On-chip Primary IDE

The chipset contains a PCI IDE interface with support for two IDE channels. Select Enabled to activate the primary IDE interface. Select Disabled to deactivate this interface. The choice: Enabled, Disabled.

## 4. BIOS SETUP

### **On-Chip Secondary IDE**

The chipset contains a PCI IDE interface with support for two IDE channels. Select Enabled to activate the secondary IDE interface. Select Disabled to deactivate this interface. The choice: Enabled, Disabled.

### **USB Keyboard Support Controller**

Select Enabled if your system contains a Universal Serial Bus (USB) Keyboard. The choice: Enabled, Disabled.

### **Init Display First**

This item allows you to decide to active whether PCI Slot or AGP first. The choices: PCI Slot, AGP.

### **Power On Function**

This item allows you to power on your system in other ways from pressing power button. The choices: Password, Hot Key, Mouse Left, Mouse Right, Any Key and Button Only.

### **Onboard FDC Controller**

Select Enabled if your system has a floppy disk controller (FDC) installed on the system board and you wish to use it. If you install and-in FDC or the system has no floppy drive, select Disabled in this field. The choice: Enabled, Disabled.

### **Onboard Serial Port 1/Port 2**

This item allows you to determine access onboard serial port 1/port 2 controller with which I/O address. The choice: 3F8/IRQ4, 2E8/IRQ3, 3E8/IRQ4, 2F8/IRQ3, Disabled, Auto.

### **UART Mode Select**

This item allows you to determine which Infra Red(IR) function of onboard I/O chip. The choices: IrDA, ASKIR, Normal.

### **Onboard Parallel Port**

This item allows you to determine access onboard parallel port controller with which I/O address. The choice: 378H/IRQ7, 278H/IRQ5, 3BC/IRQ7, Disabled.

### **Parallel Port Mode (Activated by Onboard Parallel Port)**

Select an operating mode for the onboard parallel (printer) port. Select Normal unless your hardware and software require one of the other modes offered in this field.

## 4. BIOS SETUP

The choice: PS/2, EPP1.9, ECP, ECPEPP1.9, SPP, EPP1.7.

### **ECP Mode Use DMA**

Select a DMA channel for the parallel port for use during ECP mode. The choice: 3, 1.

### **Onboard Audio Device**

This system embeds an audio chip to feature the excellent audio function. Select Enabled to use the onboard audio system or Disabled to abort.

## 4. BIOS SETUP

### 4.9 Load Setup Defaults

The chipset defaults are settings which provide for maximum system performance. While Award has designed the custom BIOS to maximize performance, the manufacturer has the right to change these defaults to meet their needs.

### 4.10 User Password

When you select this function, a message appears at the center of the screen:

**ENTER PASSWORD:**

Type the password, up to eight characters, and press Enter. Typing a password clears any previously entered password from CMOS memory. Now the message changes:

**CONFIRM PASSWORD:**

Again, type the password and press Enter.

To abort the process at any time, press Esc.

In the *Security Option* item in the **BIOS Features** Setup screen, select *System* or *Setup*:

System     Enter a password each time the system boots and whenever you enter Setup.

Setup       Enter a password whenever you enter Setup.

**NOTE:** To clear the password, simply press Enter when asked to enter a password. Then the password function is disabled.

### 4.11 IDE HDD Auto Detection

BIOS setup will display all possible modes that supported by the HDD including NORMAL, LBA & LARGE. If HDD does not support LBA modes, no 'LBA' option will be shown. If no of cylinders is less than or equal to 1024, no 'LARGE' option will be show. Users can select a mode which is appropriate for them

### 4.12 Save & Exit Setup

This feature allows the changes to be made to the CMOS setup to be saved. The system will resume booting after a successful save.

## 4. BIOS SETUP

### 4.13 Exit Without Saving

Abandon all CMOS value change without saving.