

# **EEV-EX15**

**COM Express Type 10 Evaluation Carrier Board**

## **User's Manual**

---

**2<sup>nd</sup> Ed – 03 June 2020**

# Contents

<b>1. Getting Started .....</b>	<b>4</b>
1.1 Safety Precautions .....	4
1.2 Packing List .....	4
1.3 Document Amendment History.....	5
1.4 System Specifications .....	6
1.5 Architecture Overview—Block Diagram.....	8
<b>2. Hardware Configuration .....</b>	<b>9</b>
2.1 Product Overview .....	10
2.2 Jumper and Connector List.....	11
2.3 Setting Jumpers & Connectors .....	13
2.3.1 Multi-function select (SW1).....	13
2.3.2 Clear CMOS (JBAT1) .....	13
2.3.3 ATX1 Power connector (ATX1) .....	14
2.3.4 ATX2 Power connector (ATX2) .....	14
2.3.5 CPU Fan connector (FAN1) .....	15
2.3.6 General Purpose I/O connector (JDIO1) .....	15
2.3.7 TAG connector (JTAG1).....	16
2.3.8 Front panel connector (JFP1).....	16
2.3.9 LCD backlight brightness adjustment (JVR1).....	17
2.3.10 LCD Inverter connector (JBKL1) .....	17
2.3.10.1 Signal Description – LCD Inverter connector (JBKL1) .....	17
2.3.11 LPC port connector (JLPC1) .....	18
2.3.12 Battery connector (BH1) .....	18
2.3.13 LVDS connector (LVDS1).....	19
2.3.14 EDP connector (EDP1).....	20
2.3.15 Test position connector (JTP1) .....	20
2.3.16 IET connector (IET_CB1) only used in production testing .....	21
2.3.17 COM Express connector (COM_EX_BASE1) .....	22
2.3.17.1 Signal Description – COM Express connector (COM_EX_BASE1).....	26
2.3.17.1.1 Audio Signals.....	26
2.3.17.1.2 Gigabit Ethernet Signals .....	26
2.3.17.1.3 PCI Express Signals .....	26
2.3.17.1.4 Flat Panel LVDS Signals.....	26
2.3.17.1.5 LPC Signals.....	27
2.3.17.1.6 GPIO Signals.....	27
2.3.17.1.7 Power & System Management Signals.....	27
2.3.17.1.8 SATA Signals .....	27

2.3.17.1.9	USB Signals .....	28
2.3.17.1.10	I2C Signals .....	28
2.3.17.1.11	USB3.0 Signals .....	28
2.3.17.1.12	DDI Signals.....	28
<b>2.4</b>	<b>EEV-EX15 Expansion Boards .....</b>	<b>29</b>
2.4.1	EEV-EX15 DB-A PCIe Expansion board.....	29
2.4.2	EEV-EX15 DB-B LAN Expansion board.....	29
<b>2.5</b>	<b>EEV-EX15 Expansion Boards Jumper &amp; Connector list .....</b>	<b>30</b>
2.5.1	EEV-EX15 DB-A PCIe Expansion board.....	30
2.5.2	EEV-EX15 DB-B LAN Expansion board.....	30
<b>2.6</b>	<b>EEV-EX15 DB-A PCIe Expansion board Setting .....</b>	<b>31</b>
2.6.1	+12V VIN Power select (AJPWR1/2) .....	31
2.6.2	Power connector (ACN1).....	31
2.6.3	Gold Finger (AGF1) .....	32
<b>2.7</b>	<b>EEV-EX15 DB-B LAN Expansion board Setting .....</b>	<b>33</b>
2.7.1	Gold Finger (BGF1) .....	33
<b>3.</b>	<b>Mechanical Drawing .....</b>	<b>34</b>

# 1. Getting Started

## 1.1 Safety Precautions

### Warning!



Always completely disconnect the power cord from your chassis whenever you work with the hardware. Do not make connections while the power is on. Sensitive electronic components can be damaged by sudden power surges. Only experienced electronics personnel should open the PC chassis.

### Caution!



Always ground yourself to remove any static charge before touching the CPU card. Modern electronic devices are very sensitive to static electric charges. As a safety precaution, use a grounding wrist strap at all times. Place all electronic components in a static-dissipative surface or static-shielded bag when they are not in the chassis.

## 1.2 Packing List

Before you begin installing your single board, please make sure that the following materials have been shipped:

- 1 x EEV-EX15 COM Express Type 10 Evaluation Carrier Board
- 1 x Expansion board for PCIe
- 1 x Expansion board for LAN
- 4 x M3-5L Ni Screws for installing Carrier Board
- 1 x Desiccant (5g)



---

If any of the above items is damaged or missing, contact your retailer.

---

### 1.3 Document Amendment History

Revision	Date	By	Comment
1 <sup>st</sup>	December 2018		Initial Release
2 <sup>nd</sup>	June 2020		Update 1.2 Packing List

## 1.4 System Specifications

<b>System</b>	
<b>System</b>	COM Express Type 10 CPU Module Socket: Supports COM Express Type 10 compatible CPU Modules
<b>BIOS</b>	SPI FLASH SOIC 8PIN SOCKET
<b>Expansion</b>	1PCIe Slot x 4, 1 x SDIO/DIO (optional, depend on module board) 1 x IET
<b>I/O</b>	
<b>SATA</b>	2 x SATA
<b>USB</b>	2 USB3.0 (contain 2 x USB2.0), 6 x USB2.0
<b>GPIO</b>	8-bit GPIO
<b>Display</b>	
<b>HDMI</b>	PTN3360DBS
<b>Audio</b>	
<b>AC97 Codec</b>	ALC892
<b>Audio Interface</b>	MIC In & Line Out
<b>Internal I/O Connectors</b>	
<b>CPU Fan</b>	1 x FAN
<b>LVDS</b>	1 x LVDS & 1 x eDP
<b>GPIO</b>	8-bit GPIO
<b>Carrier Board Power</b>	One Switch Button
<b>Carrier Board Switch</b>	One Switch Button
<b>Power Connector</b>	ATX, One 12 x 2-pin & 2 x 2-pin(12V Aux Power) Connector
<b>Miscellaneous Setting Connector</b>	RTC Battery x 1, DIOx4/SDIOx1(Mux with GPIO)
	1 x COM Express connector
<b>External I/O Connectors</b>	
<b>USB</b>	USB3.0(contain 2 x USB2.0), 6 x USB2.0
<b>LAN</b>	1 x RJ45
<b>HDMI</b>	DP/HDMI Connector, 1 x HDMI, 1 x DP
<b>Audio Jack</b>	2 x Audio Jack
<b>Mechanical &amp; Environmental</b>	
<b>Power Type</b>	ATX
<b>Operating Temp.</b>	Standard: 0°C to 60°C (32°F ~ 140°F)

<b>Storage Temp.</b>	-45°C to +85°C (-40°F ~ 185°F)
<b>Operating Humidity</b>	0% ~ 90% Relative Humidity, Non-condensing
<b>Size (L x W)</b> (Please consult product engineers for the production feasibility if the size is larger than 410 x 360mm or smaller than 80 x 70mm)	6.7" x 6.7" (170mm x 170mm)
<b>OS Support</b> (listed in accordance with Intel document)	According to COMe Module solution



**Note:** Specifications are subject to change without notice.

## 1.5 Architecture Overview—Block Diagram

The following block diagram shows the architecture and main components of EEV-EX15.

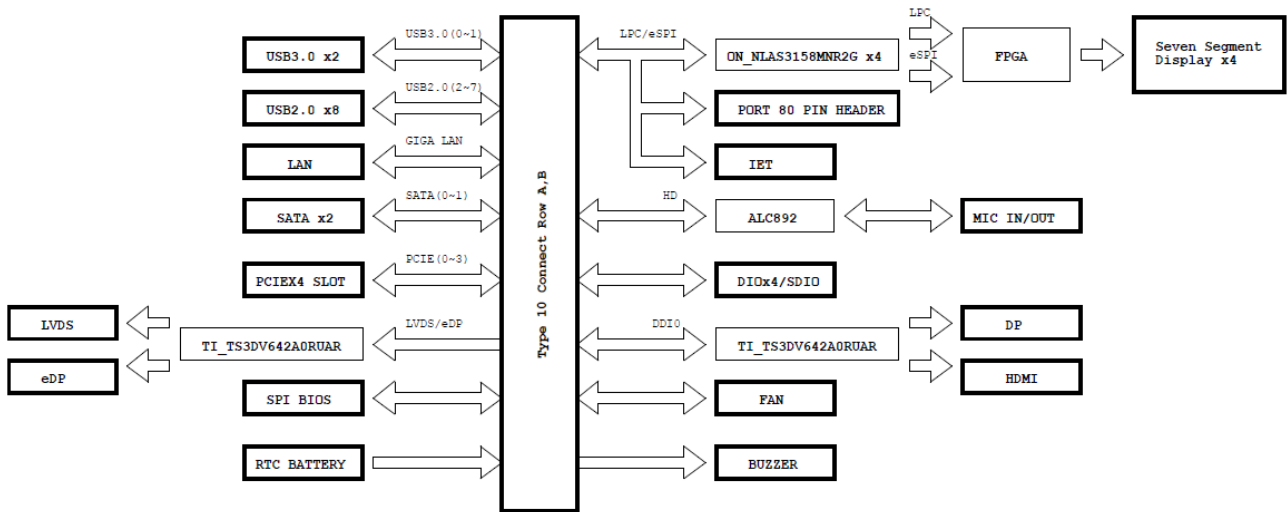



## 2. Hardware Configuration

---

## 2.1 Product Overview

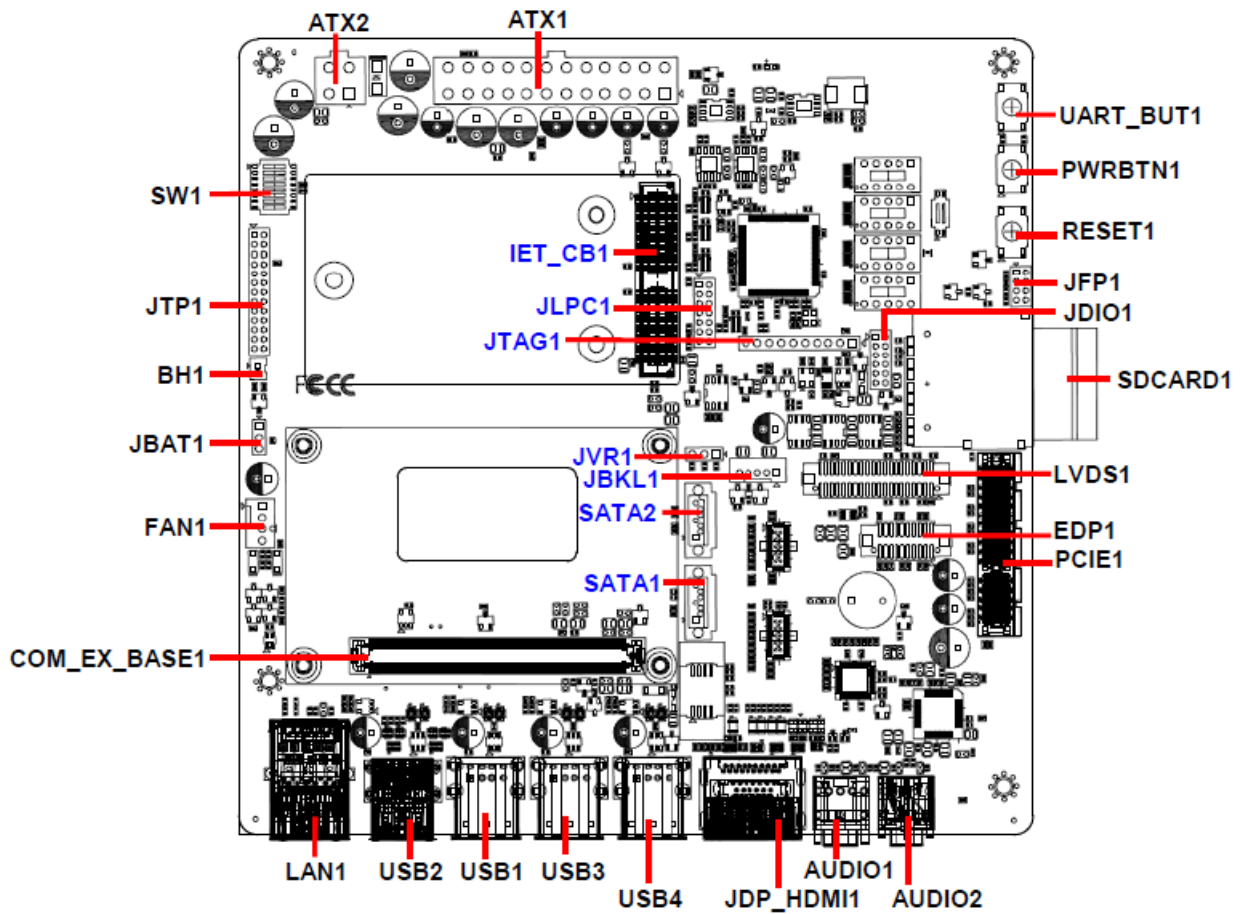

## 2.2 Jumper and Connector List

You can configure your board to match the needs of your application by setting jumpers. A jumper is the simplest kind of electric switch.

It consists of two metal pins and a small metal clip (often protected by a plastic cover) that slides over the pins to connect them. To “close” a jumper you connect the pins with the clip. To “open” a jumper you remove the clip. Sometimes a jumper will have three pins, labeled 1, 2, and 3. In this case, you would connect either two pins.

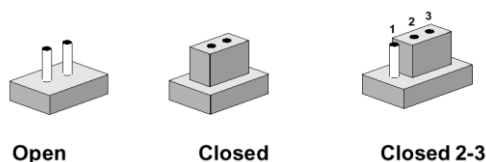

The jumper settings are schematically depicted in this manual as follows:



A pair of needle-nose pliers may be helpful when working with jumpers.

Connectors on the board are linked to external devices such as hard disk drives, a keyboard, or floppy drives. In addition, the board has a number of jumpers that allow you to configure your system to suit your application.

If you have any doubts about the best hardware configuration for your application, contact your local distributor or sales representative before you make any changes.

The following tables list the function of each of the board's jumpers and connectors.

### Jumpers

Label	Function	Note
SW1	Multi-function select	DIP switch 8pin
JBAT1	Clear CMOS	3 x 1 header, pitch 2.54mm

### Connectors

Label	Function	Note
AUDIO1/2	Audio connector 1/2	
ATX1	ATX1 Power connector	12 x 2 wafer, pitch 4.20mm
ATX2	ATX2 Power connector	2 x 2 wafer, pitch 4.20mm
FAN1	CPU fan connector	4 x 1 wafer, pitch 2.54mm
JDP_HDMI1	Display port connector /HDMI connector	

## EEV-EX15 User's Manual

<b>SDCARD1</b>	SD card slot	
<b>COM_EX_BASE1</b>	COM Express connector	
<b>JTP1</b>	Test position connector	13 x 2 header, pitch 2.00mm
<b>IET_CB1</b>	IET connector	40 x 2 wafer, pitch 0.80mm (only used in production testing)
<b>JTAG1</b>	TAG connector	10 x 1 header, pitch 2.54mm
<b>JVR1</b>	LCD backlight brightness adjustment	3 x 1 header, pitch 2.00mm
<b>LAN1</b>	Ethernet connector	
<b>JDIO1</b>	General Purpose I/O connector	6 x 2 header, pitch 2.00mm
<b>JFP1</b>	Front panel connector	4 x 2 header, pitch 2.00mm
<b>UART_BUT1</b>	UART button	
<b>PWRBTN1</b>	Power button	
<b>RESET1</b>	Reset button	
<b>USB1/3/4</b>	6 x USB2.0 connector	
<b>USB2</b>	2 x USB3.0 connector	
<b>PCIE1</b>	PCI Express connector	
<b>SATA1/2</b>	Serial ATA connector	
<b>LVDS1</b>	LVDS connector	20 x 2 box header, pitch 1.25 mm Matching Connector: Hirose DF13-40DS-1.25C
<b>JBKL1</b>	LCD Inverter connector	5 x 1 wafer, pitch 2.00mm Matching Connector: JST PHR-5
<b>JLPC1</b>	LPC port connector	7 x 2 header, pitch 2.00mm
<b>EDP1</b>	EDP connector	10 x 2 wafer, pitch 1.25mm
<b>BH1</b>	Battery connector	2 x 1 wafer, pitch 1.25mm

## 2.3 Setting Jumpers & Connectors

### 2.3.1 Multi-function select (SW1)

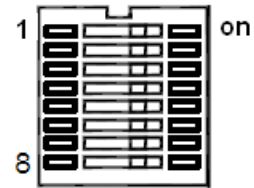
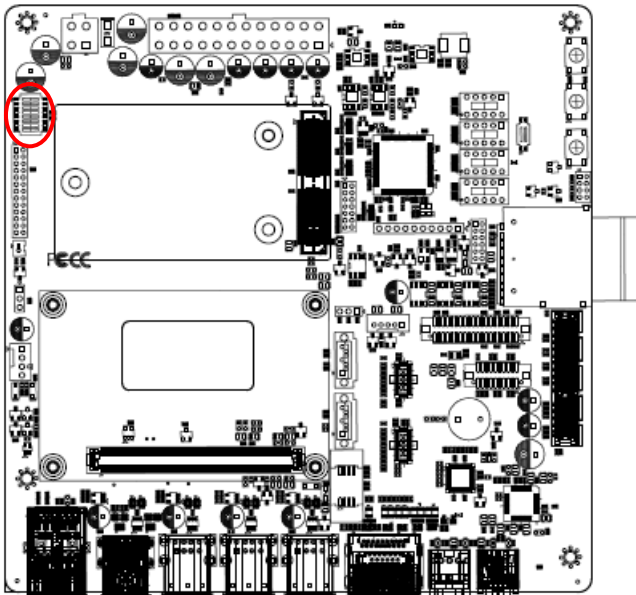

	Function	ON	OFF
1	BIOS ROM select		Default
2	BIOS ROM select		Default
3	ESPI/LPC select	ESPI	LPC
4	ERP setting	ERP ON	ERP OFF
5	PSON Control	Power button	S3
6	USB_HOST_PRSENT	SEL	NO Detect
7	DP/HDMI select (optional)	DP	HDMI
8	LVDS/eDP select (optional)	LVDS	eDP

### 2.3.2 Clear CMOS (JBAT1)

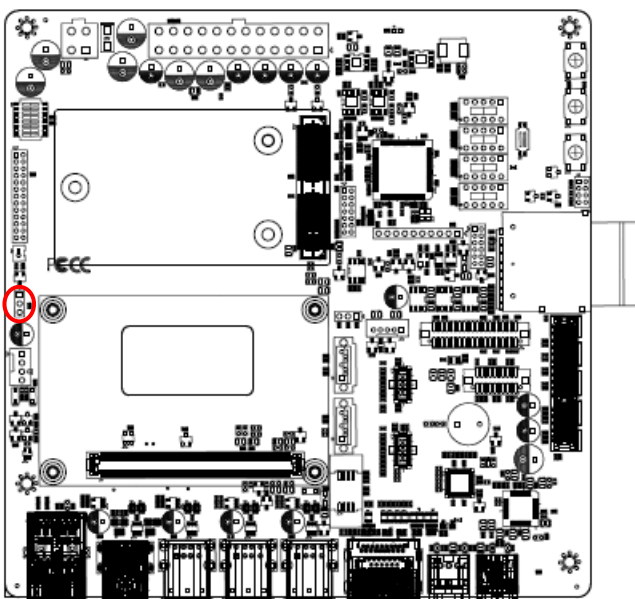

Protect\*

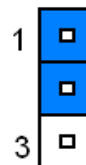

Clear CMOS

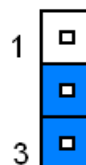

\* Default

### 2.3.3 ATX1 Power connector (ATX1)

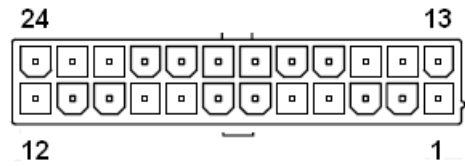
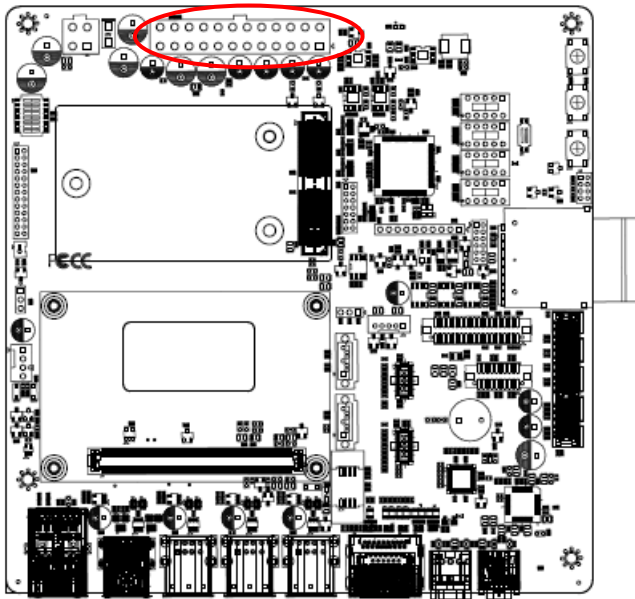

Signal	PIN	PIN	Signal
+3.3V	13	1	+3.3V
NC	14	2	+3.3V
GND	15	3	GND
PSON#	16	4	+5V
GND	17	5	GND
GND	18	6	+5V
GND	19	7	GND
NC	20	8	PWR_OK
+5V	21	9	+5VSB
+5V	22	10	+12V
+5V	23	11	+12V
GND	24	12	+3.3V

### 2.3.4 ATX2 Power connector (ATX2)

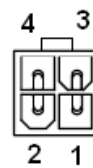
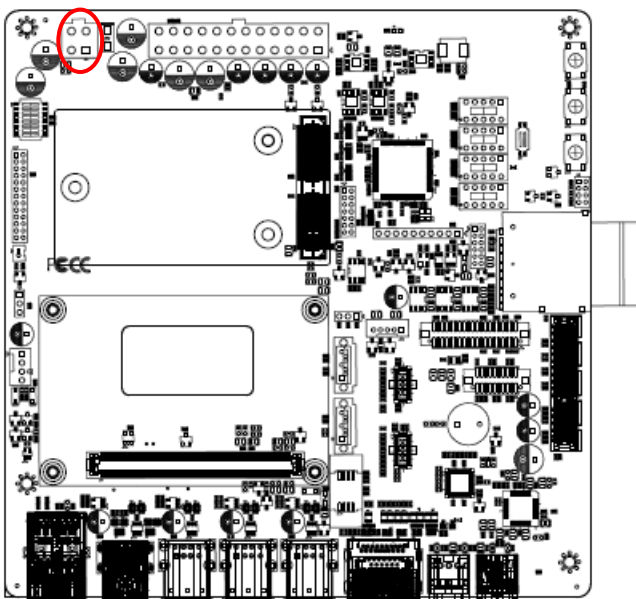

Signal	PIN	PIN	Signal
+VIN	4	3	+VIN
GND	2	1	GND

### 2.3.5 CPU Fan connector (FAN1)

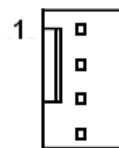
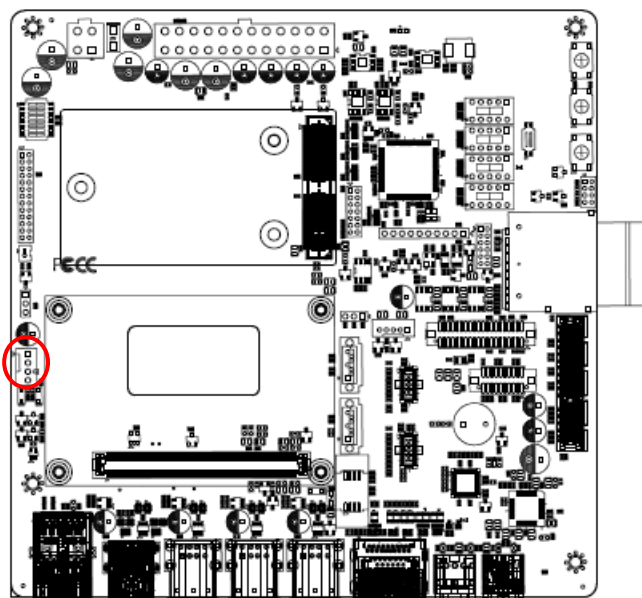

Signal	PIN
GND	1
+12V	2
FAN_TACHIM	3
+5V	4

### 2.3.6 General Purpose I/O connector (JDIO1)

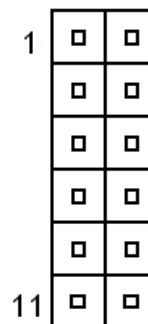
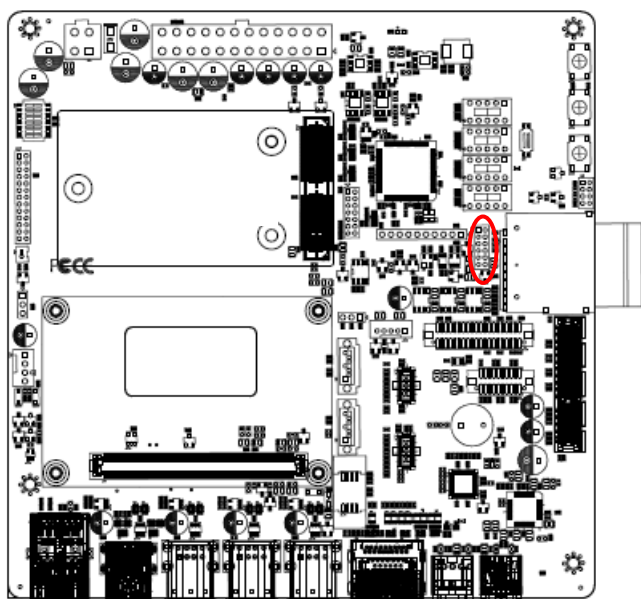

Signal	PIN	PIN	Signal
DIO_OUT0_SD_CLK	1	2	DIO_IN0_SD_DATA0
DIO_OUT1_SD_CMD	3	4	DIO_IN1_SD_DATA1
DIO_OUT2_SD_WP	5	6	DIO_IN2_SD_DATA2
DIO_OUT3_SD_CD#	7	8	DIO_IN3_SD_DATA3
SMB_CLK	9	10	SMB_DAT
GND	11	12	+5V

2.3.7 TAG connector (JTAG1)

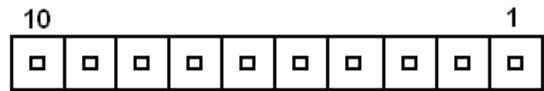
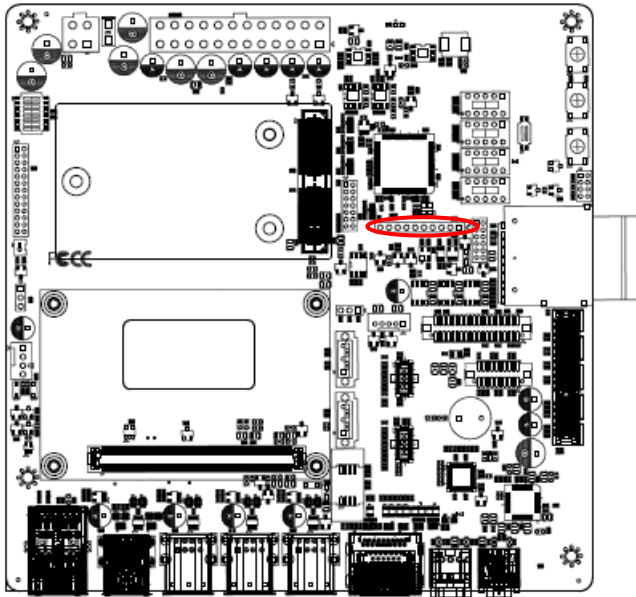

Signal	PIN
+3.3V	1
GAL1_TCK	2
GAL1_TDO	3
GAL1_TDI	4
GAL1_TMS	5
GND	6
I2C_DAT_UART_TX	7
I2C_CLK_UART_RX	8
GAL1_EN	9
+3.3V	10

2.3.8 Front panel connector (JFP1)

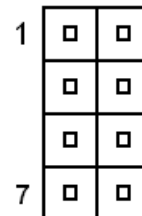
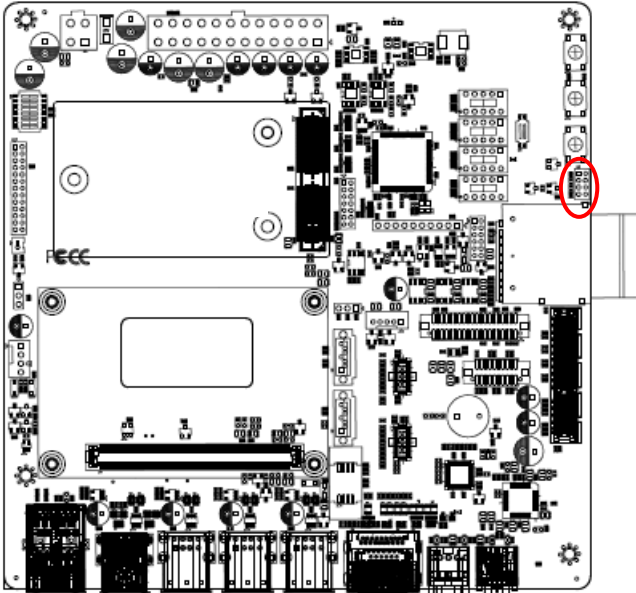

Signal	PIN	PIN	Signal
EXT_PWRBTN#	1	2	GND
SYS_RERST#	3	4	GND
+5V	5	6	GND
+5V	7	8	SATA_LED_OUT#

Pin	1	2	3	4	5	6	7	8
Signal	Power Button		Reset		Power LED		SATA LED	



### 2.3.9 LCD backlight brightness adjustment (JVR1)

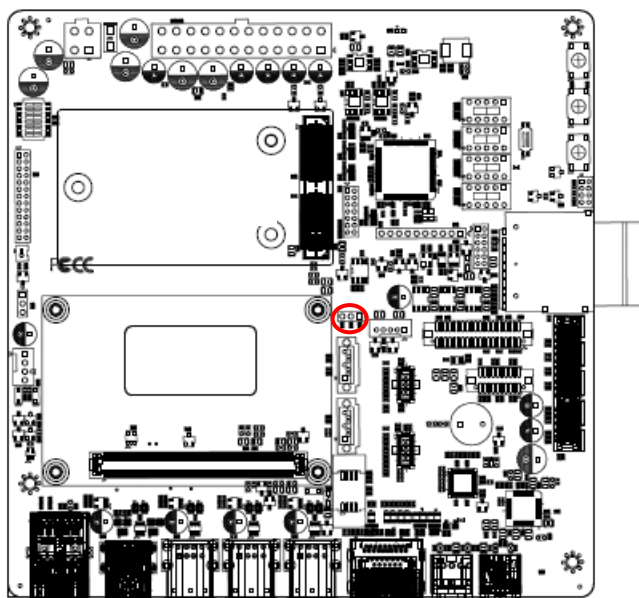

Signal	PIN
+5V	1
EDP_BRIGHT_CTRL	2
GND	3

### 2.3.10 LCD Inverter connector (JBKL1)

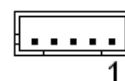
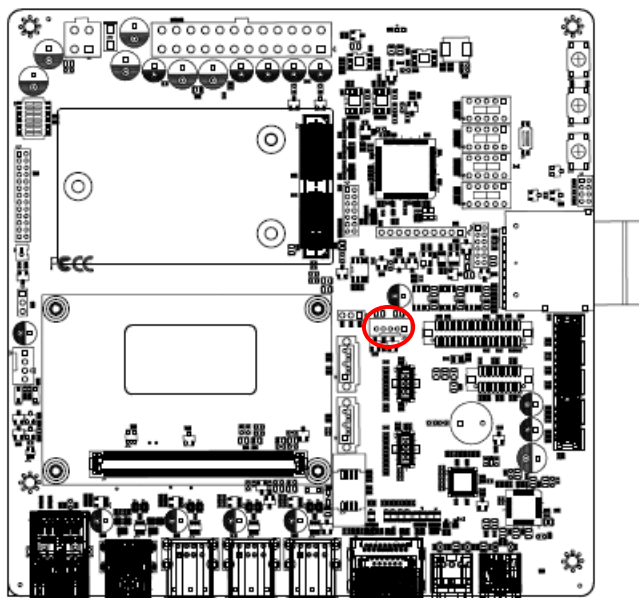

Signal	PIN
+VCC_BKL	1
GND	2
BKLEN	3
EDP_BRIGHT_CTRL	4
+5V	5

#### 2.3.10.1 Signal Description – LCD Inverter connector (JBKL1)

Signal	Signal Description
LVDS_BKLT_CTRL	when LVDS_BKLT_CTRL is controlled by carrier board's JVR1, Vadj = 0.75V ~ 4.25V (Recommended: 4.7KΩ, >1/16W)
BKLEN	LCD backlight ON/OFF control signal

# EEV-EX15 User's Manual

## 2.3.11 LPC port connector (JLPC1)

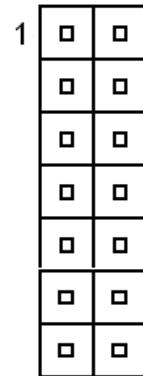
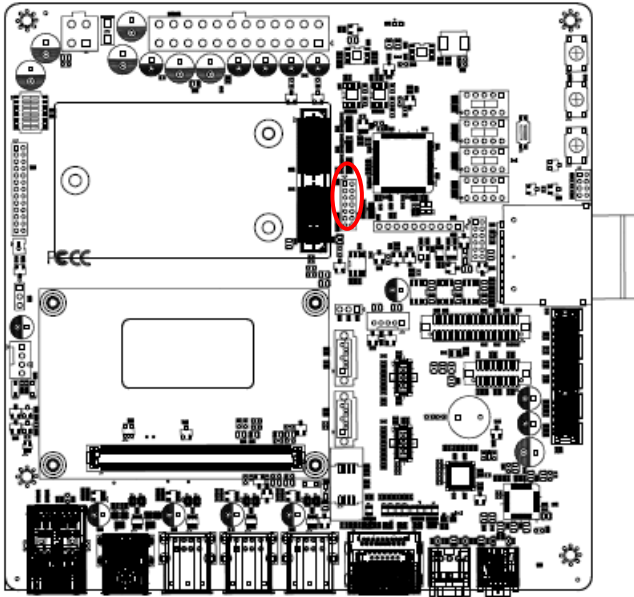

Signal	PIN	PIN	Signal
LPC_AD0/ESPI_IO_0	1	2	+3.3V
LPC_AD1/ESPI_IO_1	3	4	JLPC_RST#
LPC_AD2/ESPI_IO_2	5	6	LPC_FRAME#/ESPI_CS0#
LPC_AD3/ESPI_IO_3	7	8	PORT80_CLK
LPC_SERIRQ/ESPI_CS1#	9	10	GND
+5V	11	12	GND
+5VSB	13	14	LPC_DRQ1#/ESPI_ALERT1

## 2.3.12 Battery connector (BH1)

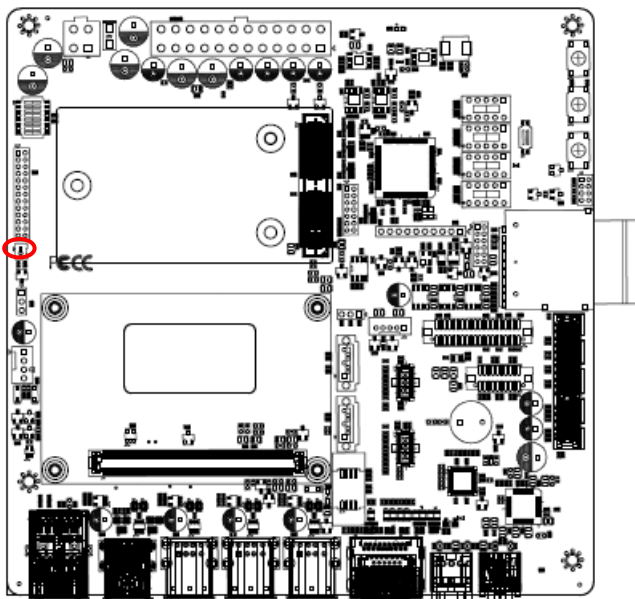

Signal	PIN
+3.3VSB	1
GND	2

### 2.3.13 LVDS connector (LVDS1)

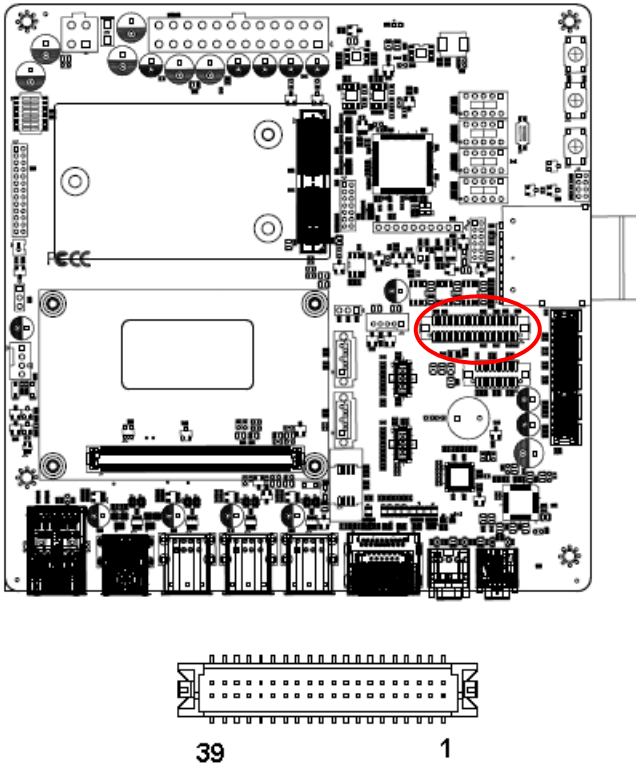

Signal	PIN	PIN	Signal
+5V	2	1	+3.3V
+5V	4	3	+3.3V
LVDS_DDC_SD	6	5	LVDS_DDC_SC
GND	8	7	GND
LVDSA_DATA0	10	9	LVDSA_DATA1
LVDSA_DATA0#	12	11	LVDSA_DATA1#
GND	14	13	GND
LVDSA_DATA2	16	15	LVDSA_DATA3
LVDSA_DATA2#	18	17	LVDSA_DATA3#
GND	20	19	GND
NC	22	21	NC
NC	24	23	NC
GND	26	25	GND
NC	28	27	NC
NC	30	29	NC
GND	32	31	GND
LVDSA_CLK	34	33	NC
LVDSA_CLK#	36	35	NC
GND	38	37	GND
+12V	40	39	+12V

2.3.14 EDP connector (EDP1)

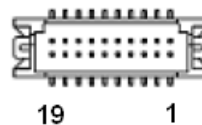
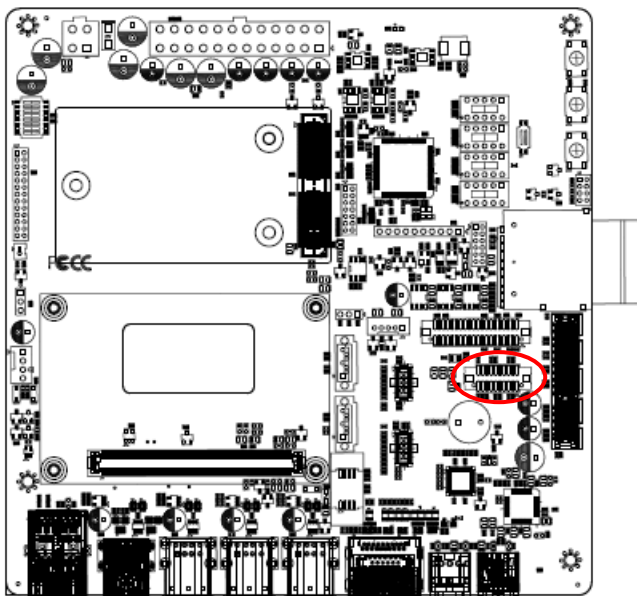

Signal	PIN	PIN	Signal
GND	2	1	GND
EDP_TX3#	4	3	EDP_TX0#
EDP_TX3	6	5	EDP_TX0
NC	8	7	GND
GND	10	9	EDP_TX1#
EDP_AUX#	12	11	EDP_TX1
EDP_AUX	14	13	GND
GND	16	15	EDP_TX2#
EMB_HPD	18	17	EDP_TX2
+VDD_EDP	20	19	+VDD_EDP

2.3.15 Test position connector (JTP1)

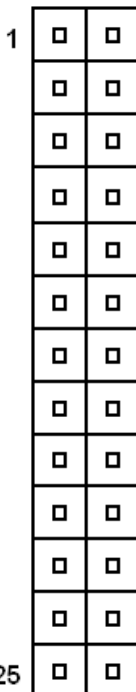
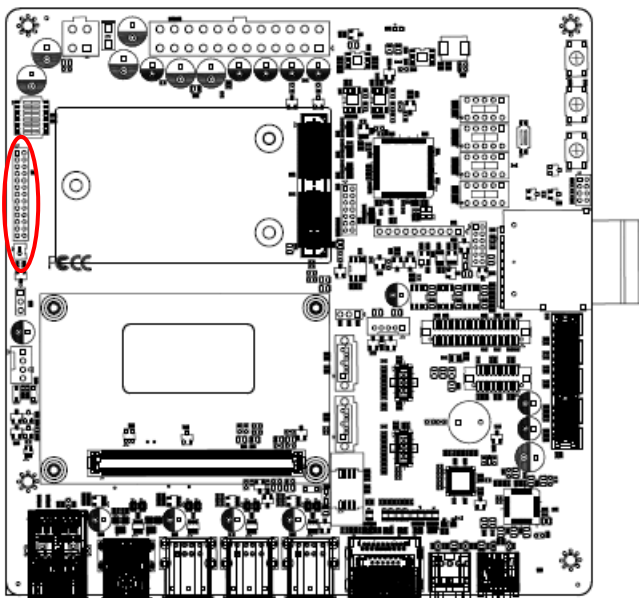

Signal	PIN	PIN	Signal
SER0_TX	1	2	SER0_RX
SER1_TX	3	4	SER1_RX
I2C_CK	5	6	I2C_DAT
TPM_PP	7	8	+3.3VSB
LID#	9	10	GND
SLEEP#	11	12	GND
GBE0_SDP	13	14	GND
USB0_HOST_PRSENT	15	16	GND
SMB_ALERT#	17	18	GND
THRM#	19	20	GND
WAKE0#	21	22	GND
WAKE1#	23	24	GND
BATLOW#	25	26	GND

2.3.16 IET connector (IET\_CB1) only used in production testing

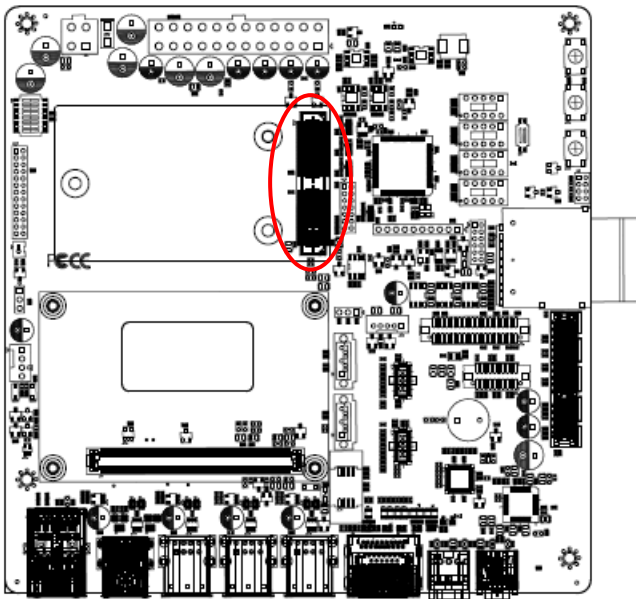

Signal	PIN	PIN	Signal
GND	1	2	GND
NC	3	4	NC
NC	5	6	NC
GND	7	8	GND
NC	9	10	NC
NC	11	12	NC
GND	13	14	GND
NC	15	16	NC
NC	17	18	NC
GND	19	20	GND

Signal	PIN	PIN	Signal
NC	21	22	NC
NC	23	24	NC
GND	25	26	GND
NC	27	28	NC
NC	29	30	NC
GND	31	32	NC
SMB_CLK	33	34	NC
SMB_DAT	35	36	NC
WAKE1#	37	38	NC
CB_RST#	39	40	ESPI_RESET#
SLP_S3#	41	42	IET_CLK
NC	43	44	LPC_AD0/ESPI_IO_0
NC	45	46	LPC_AD1/ESPI_IO_1
GND	47	48	LPC_AD2/ESPI_IO_2
NC	49	50	LPC_AD3/ESPI_IO_3
NC	51	52	LPC_DRQ0#/ESPI_ALERT0
GND	53	54	LPC_SERIRQ/ESPI_CS1#
NC	55	56	LPC_FRAME#/ESPI_CS0#
NC	57	58	GND
GND	59	60	NC
NC	61	62	NC
NC	63	64	GND
GND	65	66	NC
NC	67	68	NC
NC	69	70	GND
GND	71	72	NC
NC	73	74	NC
NC	75	76	GND
GND	77	78	NC
+12V	79	80	+12V

2.3.17 COM Express connector (COM\_EX\_BASE1)

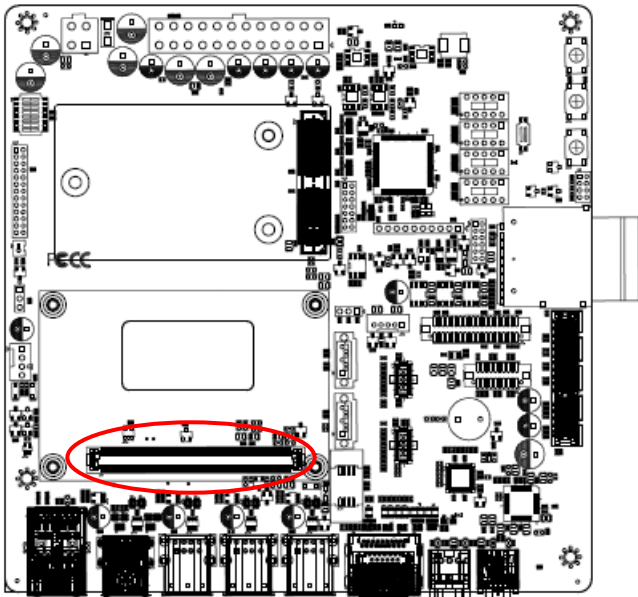

Signal	PIN	PIN	Signal
GND	A1	B1	GND
GBE0_MDI3-	A2	B2	GBE0_ACT#
GBE0_MDI3+	A3	B3	LPC_FRAME# /ESPI_CS0#
GBE0_LINK100#	A4	B4	LPC_AD0 /ESPI_IO_0
GBE0_LINK1000#	A5	B5	LPC_AD1 /ESPI_IO_1
GBE0_MDI2-	A6	B6	LPC_AD2 /ESPI_IO_2
GBE0_MDI2+	A7	B7	LPC_AD3 /ESPI_IO_3
GBE0_LINK#	A8	B8	LPC_DRQ0# /ESPI_ALERT0#
GBE0_MDI1-	A9	B9	LPC_DRQ1# /ESPI_ALERT1#
GBE0_MDI1+	A10	B10	LPC_CLK /ESPI_CK
GND	A11	B11	GND
GBE0_MDI0-	A12	B12	PWRBTN#
GBE0_MDI0+	A13	B13	SMB_SCL_S5
GBE0_CTREF	A14	B14	SMB_SDA_S5
SUS_S3#	A15	B15	SMB_ALERT#
SATA0_TX+	A16	B16	SATA1_TX+
SATA0_TX-	A17	B17	SATA1_TX-
PCH_SLP_S4#	A18	B18	SUS_STAT# /ESPI_RESET#
SATA0_RX+	A19	B19	SATA1_RX+
SATA0_RX-	A20	B20	SATA1_RX-
GND	A21	B21	GND
USB_SSRX0-	A22	B22	USB_SSTX0-
USB_SSRX0+	A23	B23	USB_SSTX0+
SUS_S5#	A24	B24	PWR_OK
USB_SSRX1-	A25	B25	USB_SSTX1-
USB_SSRX1+	A26	B26	USB_SSTX1+
BATLOW#	A27	B27	WDT
(S)ATA_ACT#	A28	B28	NC
HDA_SYNC	A29	B29	NC
HDA_RST#	A30	B30	HDA_SDI0

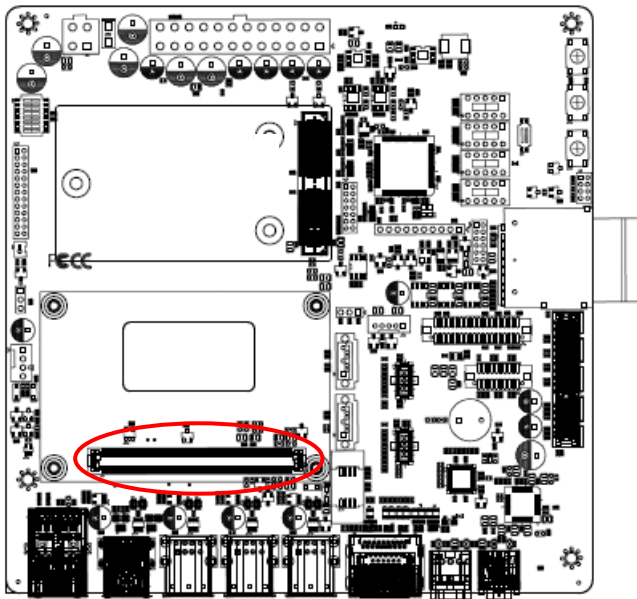

Signal	PIN	PIN	Signal
GND	A31	B31	GND
HAD_BITCLK	A32	B32	SPKR
HAD_SDOOUT	A33	B33	I2C_CLK
BIOS_DIS0# /ESPI_SAFS	A34	B34	I2C_DATA
THRMTRIP#	A35	B35	THRM#
USB6-	A36	B36	USB7-
USB6+	A37	B37	USB7+
USB_6_7_OC#	A38	B38	USB_4_5_OC#
USB4-	A39	B39	USB5-
USB4+	A40	B40	USB5+
GND	A41	B41	GND
USB2-	A42	B42	USB3-
USB2+	A43	B43	USB3+
USB_2_3_OC#	A44	B44	USB_0_1_OC#
USB0-	A45	B45	USB1-
USB0+	A46	B46	USB1+
+3.3V	A47	B47	ESPI_EN#
NC	A48	B48	USB0_HOST_PRSNT
GBE0_SDP	A49	B49	SYS_RESET#
LPC_SERIRQ /ESPI_CS1#	A50	B50	CB_RESET#
GND	A51	B51	GND
NC	A52	B52	NC
NC	A53	B53	NC
GPI0/SD_DATA0	A54	B54	GPO1/SD_CMD
NC	A55	B55	NC
NC	A56	B56	NC
GND	A57	B57	GPO2/SD_WP
PCIE_TX3+	A58	B58	PCIE_RX3+
PCIE_TX3-	A59	B59	PCIE_RX3-
GND	A60	B60	GND

# EEV-EX15 User's Manual

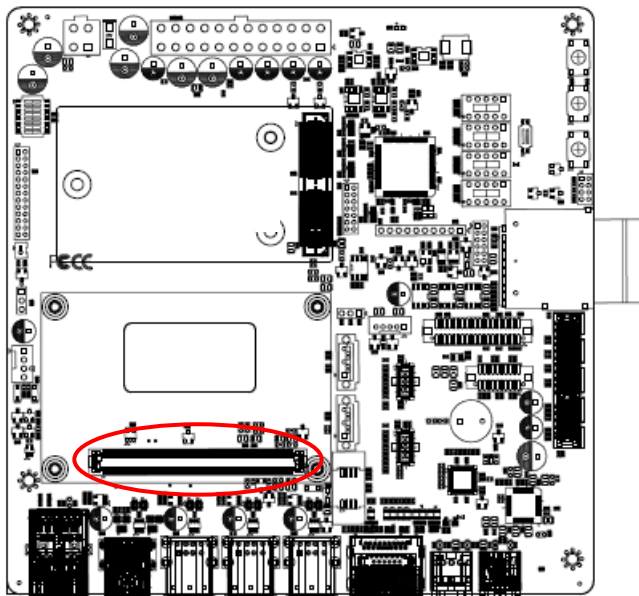

Signal	PIN	PIN	Signal
PCIE_TX2+	A61	B61	PCIE_RX2+
PCIE_TX2-	A62	B62	PCIE_RX2-
GPI1/SD_DATA1	A63	B63	GPO3/SD_CD#
PCIE_TX1+	A64	B64	PCIE_RX1+
PCIE_TX1-	A65	B65	PCIE_RX1-
GND	A66	B66	WAKE0#
GPI2/SD_DATA2	A67	B67	WAKE1#
PCIE_TX0+	A68	B68	PCIE_RX0+
PCIE_TX0-	A69	B69	PCIE_RX0-
GND	A70	B70	GND
LVDS_A0+ /EDP_TX2+	A71	B71	DDI0_PAIR0+
LVDS_A0- /EDP_TX2-	A72	B72	DDI0_PAIR0-
LVDS_A1+ /EDP_TX1+	A73	B73	DDI0_PAIR1+
LVDS_A1- /EDP_TX1-	A74	B74	DDI0_PAIR1-
LVDS_A2+ /EDP_TX0+	A75	B75	DDI0_PAIR2+
LVDS_A2- /EDP_TX0-	A76	B76	DDI0_PAIR2-
LVDS_VDD_EN /EDP_VDD_EN	A77	B77	NC
LVDS_A3+	A78	B78	NC
LVDS_A3-	A79	B79	LVDS_BKLT_EN/ EDP_BKLT_EN
GND	A80	B80	GND
LVDS_A_CK+ /EDP_TX3+	A81	B81	DDI0_PAIR3+
LVDS_A_CK- /EDP_TX3-	A82	B82	DDI0_PAIR3-
LVDS_I2C_CK /EDP_AUX+	A83	B83	LVDS_BKLT_CTRL/ EDP_BKLT_CTRL
LVDS_I2C_DAT /EDP_AUX-	A84	B84	+ATX5VSB
GPI3/SD_DATA3	A85	B85	+ATX5VSB
NC	A86	B86	+ATX5VSB
CB_EDP_HDP	A87	B87	+ATX5VSB
PCIE_CLK_REF+	A88	B88	BIOS_DIS1#
PCIE_CLK_REF-	A89	B89	DDI0_HPD
GND	A90	B90	GND



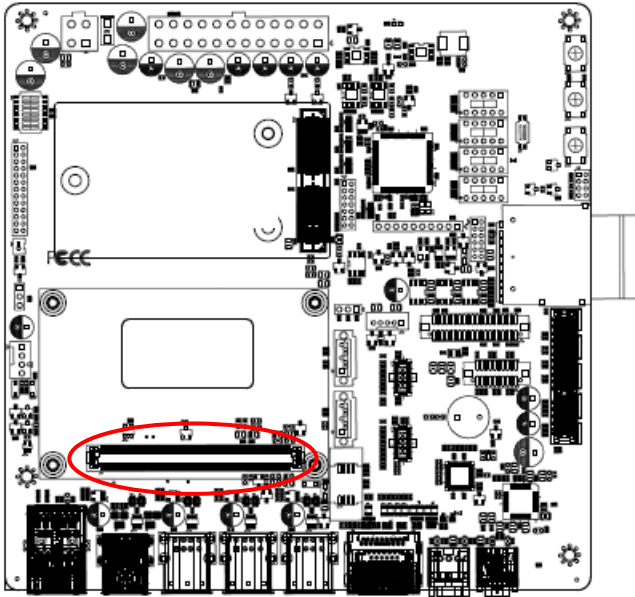

Signal	PIN	PIN	Signal
SPI_POWER	A91	B91	NC
SPI_MISO	A92	B92	NC
GPO0 /SD_CLK	A93	B93	NC
SPI_CLK	A94	B94	NC
SPI_MOSI	A95	B95	DDIO_DDC_AUX_SEL
TPM_PP	A96	B96	USB7_HOST_PRSNT
TYPE10#	A97	B97	NC
SER0_TX	A98	B98	DDIO_CTRLCLK_AUX+
SER0_RX	A99	B99	DDIO_CTRLDATA_AUX-
GND	A100	B100	GND
SER1_TX	A101	B101	FAN_PWMOUT
SER1_RX	A102	B102	FAN_TACHIN
LID#	A103	B103	SLEEP#
VCC	A104	B104	VCC
VCC	A105	B105	VCC
VCC	A106	B106	VCC
VCC	A107	B107	VCC
VCC	A108	B108	VCC
VCC	A109	B109	VCC
GND	A110	B110	GND

2.3.17.1 Signal Description – COM Express connector (COM\_EX\_BASE1)

2.3.17.1.1 Audio Signals

Signal	Signal Description
HDA_SYNC	HD Audio Sync
HDA_RST#	HD Audio Reset

2.3.17.1.2 Gigabit Ethernet Signals

Signal	Signal Description																				
GBE0_MD[0:3] +/-	Gigabit Ethernet Controller 0: Media Dependent Interface Differential Pairs 0,1,2,3. The MDI can operate in 1000, 100 and 10 Mbit / sec modes. Some pairs are unused in some modes, per the following:																				
	<table border="1"> <thead> <tr> <th></th> <th>1000B-T</th> <th>100B-T</th> <th>10B-T</th> </tr> </thead> <tbody> <tr> <td>MDI[0] +/-</td> <td>B1_DA+ /</td> <td>TX+ / -</td> <td>TX+ / -</td> </tr> <tr> <td>MDI[1] + /</td> <td>B1_DB+ /</td> <td>RX+ / -</td> <td>RX+ / -</td> </tr> <tr> <td>MDI[2] + /</td> <td>B1_DC+ /</td> <td>X</td> <td>X</td> </tr> <tr> <td>MDI[3] + /</td> <td>B1_DD+ /</td> <td>X</td> <td>X</td> </tr> </tbody> </table>		1000B-T	100B-T	10B-T	MDI[0] +/-	B1_DA+ /	TX+ / -	TX+ / -	MDI[1] + /	B1_DB+ /	RX+ / -	RX+ / -	MDI[2] + /	B1_DC+ /	X	X	MDI[3] + /	B1_DD+ /	X	X
		1000B-T	100B-T	10B-T																	
	MDI[0] +/-	B1_DA+ /	TX+ / -	TX+ / -																	
	MDI[1] + /	B1_DB+ /	RX+ / -	RX+ / -																	
MDI[2] + /	B1_DC+ /	X	X																		
MDI[3] + /	B1_DD+ /	X	X																		
GBE0_ACT#	Gigabit Ethernet Controller 0 activity indicator, active low.																				
GBE0_Link#	Gigabit Ethernet Controller 0 link indicator, active low.																				
GBE0_Link100#	Gigabit Ethernet Controller 0 100 Mbit / sec link indicator, active low.																				
GBE0_Link1000#	Gigabit Ethernet Controller 0 1000 Mbit / sec link indicator, active low.																				

2.3.17.1.3 PCI Express Signals

Signal	Signal Description
PCIE_TX[0:3] +/-	PCI Express Differential Transmit Pair 0-3
PCIE_RX[0:3] +/-	PCI Express Differential Receive Pair 0-3

2.3.17.1.4 Flat Panel LVDS Signals

Signal	Signal Description
LVDS_BKLT_CTRL	Controls panel digital power.
LVDS_I2C_CLK	I2C clock output for LVDS display use.
LVDS_I2C_DAT	I2C data line for LVDS display use.
LVDS_VDD_EN	LVDS panel power enables.

## 2.3.17.1.5 LPC Signals

Signal	Signal Description
LPC_FRAME#/ESPI_CS0#	LPC frame indicates the start of an LPC cycle
LPC_AD[0:3]	LPC multiplexed address, command and data bus
LPC_CLKOUT1	LPC clock output - 33MHz nominal
LPC_SERIRQ	LPC serial interrupt

## 2.3.17.1.6 GPIO Signals

Signal	Signal Description
GPI[0:4]	General purpose input pins.
GPO[0:4]	General purpose output pins.

## 2.3.17.1.7 Power &amp; System Management Signals

Signal	Signal Description
SUS_S3#	Indicates system is in Suspend to RAM state. Active low output.
BATLOW#	Indicates that external battery is low
PWRBTN#	Power button to bring system out of S5 (soft off), active on rising edge.
SMB_SCL_S5	System Management Bus bidirectional clock line.
SMB_SDA_S5	System Management Bus bidirectional data line.
SMB_ALERT#	System Management Bus Alert - input can be used to generate an SMI# (System Management Interrupt) or to wake the system.
SUS_STAT#/ESPI_RESET#	Indicates imminent suspend operation.
PWR_OK	Power OK from main power supply
SYS_RESET#	Reset button input. Active low input.
WAKE0#	PCI Express wake up signal.
WAKE1#	General purpose wake up signal.

## 2.3.17.1.8 SATA Signals

Signal	Signal Description
SATA[0:1]_TX +/-	Serial ATA Channel 0-1 transmit differential pair.
SATA[0:1]_RX +/-	Serial ATA Channel 0-1 receive differential pair.
ATA_ACT#	ATA (parallel and serial) activity indicator, active low.

## EEV-EX15 User's Manual

### 2.3.17.1.9 USB Signals

Signal	Signal Description
USB[0:7] +/-	USB differential pairs, channels 0 through 7
USB_0_1_OC#	USB over-current sense, USB channels 0 and 1
USB_2_3_OC#	USB over-current sense, USB channels 2 and 3
USB_4_5_OC#	USB over-current sense, USB channels 4 and 5
USB_6_7_OC#	USB over-current sense, USB channels 6 and 7

### 2.3.17.1.10 I2C Signals

Signal	Signal Description
I2C_CLK	General purpose I2C port clock output.
I2C_DATA	General purpose I2C port data I/O line.

### 2.3.17.1.11 USB3.0 Signals

Signal	Signal Description
USB_SSTX[0:1]+ USB_SSTX[0:1]-	Additional transmit signal differential pairs for the SuperSpeed USB data path.
USB_SSRX[0:1]+ USB_SSRX[0:1]-	Additional receive signal differential pairs for the SuperSpeed USB data path.

### 2.3.17.1.12 DDI Signals

Signal	Signal Description
DDI0_PAIR[0:2]+ DDI0_PAIR[0:2]-	Digital Display Interface0 Pair[0:2] differential pairs
DDI0_DDC_AUX_SEL	Selects the function of DDI0_CTRLCLK_AUX+ and DDI0_CTRLDATA_AUX-. If this input is floating the AUX pair is used for the DP AUX+/- signals. If pulled-high the AUX pair contains the CTRLCLK and CTRLDATA signals.
DDI0_CTRLCLK_AUX+	DP AUX+function if DDI0_DDC_AUX_SEL is no connect HDMI/DVI 12C CTRLCLK if DDI0_DDC_AUX_SEL is pulled high
DDI0_CTRLDATA_AUX-	DP AUX-function if DDI0_DDC_AUX_SEL is no connect HDMI/DVI 12C CTRLDATA if DDI0_DDC_AUX_SEL is pulled high
DDI0_HPD	Digital Display Interface Hot-Plug Detect

## 2.4 EEV-EX15 Expansion Boards

### 2.4.1 EEV-EX15 DB-A PCIe Expansion board

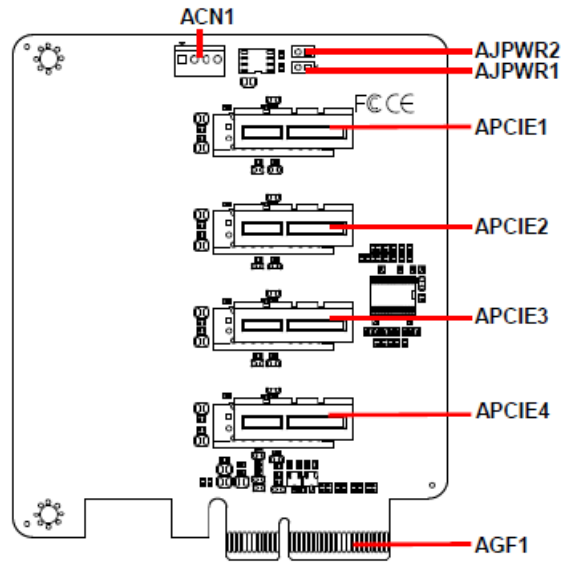

### 2.4.2 EEV-EX15 DB-B LAN Expansion board

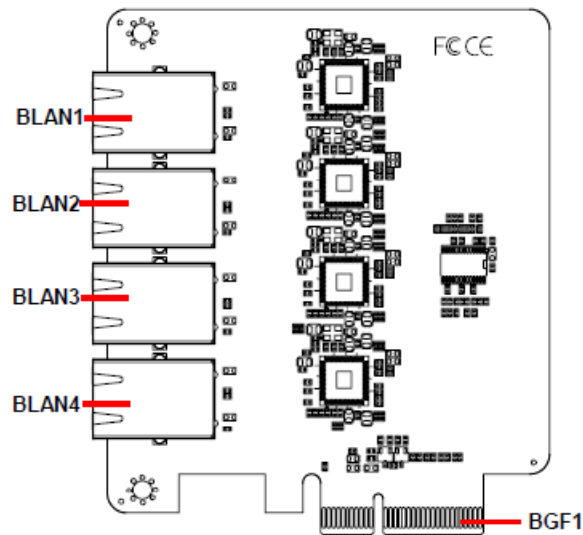

## 2.5 EEV-EX15 Expansion Boards Jumper & Connector list

### 2.5.1 EEV-EX15 DB-A PCIe Expansion board

#### Jumpers

Label	Function	Note
AJPWR1/2	+12V VIN Power select	2 x 1 header, pitch 2.00mm

#### Connectors

Label	Function	Note
APCIE1/2/3/4	PCIE connector (into the PCIE2)	
ACN1	Power connector	4 x 1 wafer, pitch 2.54mm
AGF1	Gold Finger	

### 2.5.2 EEV-EX15 DB-B LAN Expansion board

#### Connectors

Label	Function	Note
BLAN1/2/3/4	Ethernet connector 1/2/3/4	Connectors standby mode doesn't work
BGF1	Gold Finger	

## 2.6 EEV-EX15 DB-A PCIe Expansion board Setting

### 2.6.1 +12V VIN Power select (AJPWR1/2)

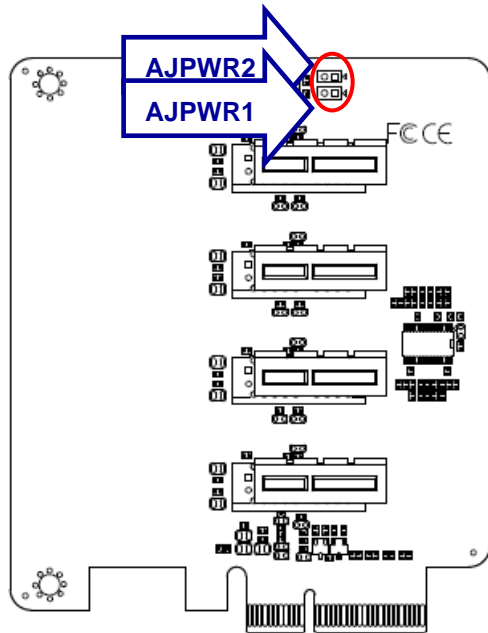

PCIEx4 Power\*    CN1(S4P) Power

AJPWR2

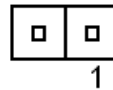

AJPWR2

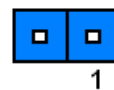

AJPWR1

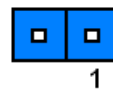

AJPWR1

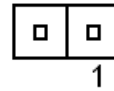

\* Default

### 2.6.2 Power connector (ACN1)

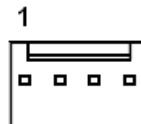
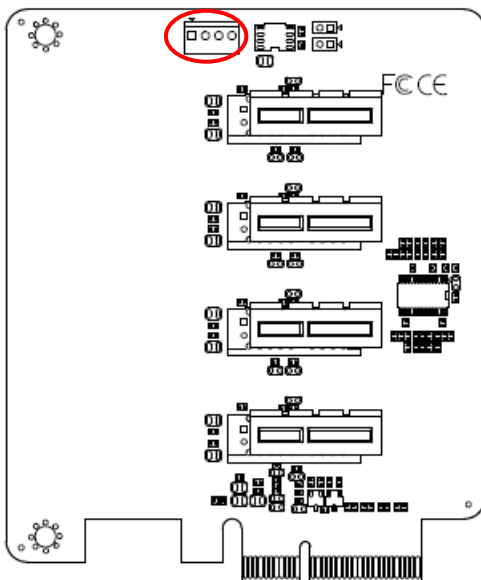

Signal	PIN
NC	1
GND	2
GND	3
+12V	4

2.6.3 Gold Finger (AGF1)

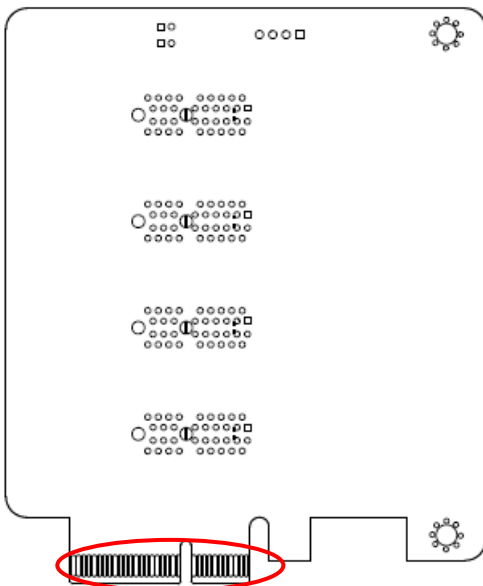
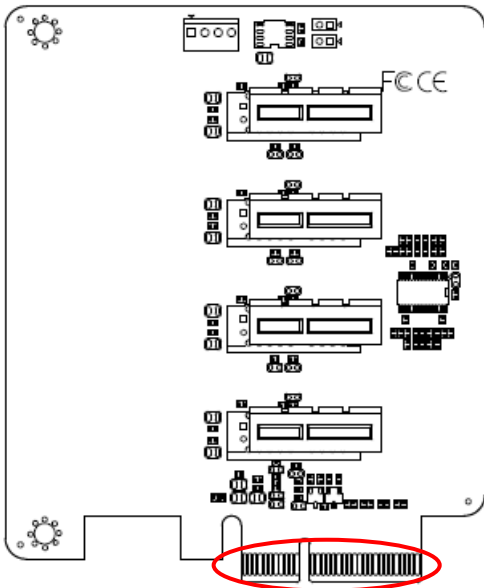

Signal	PIN	PIN	Signal
+12V	B1	A1	GND
+12V	B2	A2	+12V
+12V	B3	A3	+12V
GND	B4	A4	GND
SMB_CLK_P4P1	B5	A5	NC
SMB_DAT_P4P1	B6	A6	NC
GND	B7	A7	NC
+3.3V	B8	A8	NC
NC	B9	A9	+3.3V
+3.3VSB	B10	A10	+3.3V
PCIE_WAKE#_P4P1	B11	A11	CB_RST#_P4P1
NC	B12	A12	GND
GND	B13	A13	PCIE_CLK_REF_P4P1
PCIE_TXP_0_P4P1	B14	A14	PCIE_CLK_REF#_P4P1
PCIE_TXN_0_P4P1	B15	A15	GND
GND	B16	A16	PCIE_RXP_0_P4P1
NC	B17	A17	PCIE_RXN_0_P4P1
GND	B18	A18	GND
PCIE_TXP_1_P4P1	B19	A19	NC
PCIE_TXN_1_P4P1	B20	A20	GND
GND	B21	A21	PCIE_RXP_1_P4P1
GND	B22	A22	PCIE_RXN_1_P4P1
PCIE_TXP_2_P4P1	B23	A23	GND
PCIE_TXN_2_P4P1	B24	A24	GND
GND	B25	A25	PCIE_RXP_2_P4P1
GND	B26	A26	PCIE_RXN_2_P4P1
PCIE_TXP_3_P4P1	B27	A27	GND
PCIE_TXN_3_P4P1	B28	A28	GND
GND	B29	A29	PCIE_RXP_3_P4P1
NC	B30	A30	PCIE_RXN_3_P4P1
NC	B31	A31	GND
GND	B32	A32	NC



## 2.7 EEV-EX15 DB-B LAN Expansion board Setting

### 2.7.1 Gold Finger (BGF1)

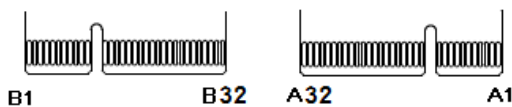
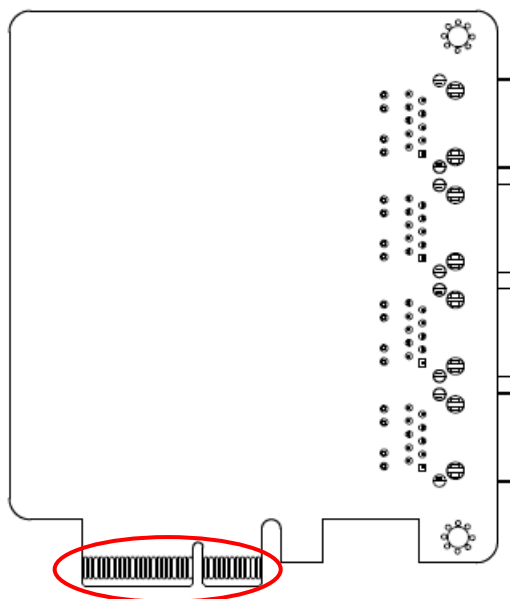
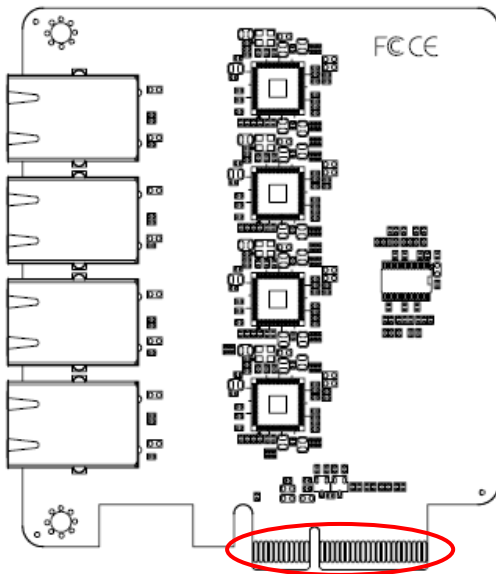

Signal	PIN	PIN	Signal
NC	B1	A1	GND
NC	B2	A2	NC
NC	B3	A3	NC
GND	B4	A4	GND
SMB_CLK_P4L	B5	A5	NC
SMB_DAT_P4L	B6	A6	NC
GND	B7	A7	NC
+3.3V	B8	A8	NC
NC	B9	A9	+3.3V
NC	B10	A10	+3.3V
PCIE_WAKE#_P4L	B11	A11	CB_RST#_P4L
NC	B12	A12	GND
GND	B13	A13	PCIE_CLK_REF_P4L
PCIE_TXP_0_P4L	B14	A14	PCIE_CLK_REF#_P4L
PCIE_TXN_0_P4L	B15	A15	GND
GND	B16	A16	PCIE_RXP_0_P4L
NC	B17	A17	PCIE_RXN_0_P4L
GND	B18	A18	GND
PCIE_TXP_1_P4L	B19	A19	NC
PCIE_TXN_1_P4L	B20	A20	GND
GND	B21	A21	PCIE_RXP_1_P4L
GND	B22	A22	PCIE_RXN_1_P4L
PCIE_TXP_2_P4L	B23	A23	GND
PCIE_TXN_2_P4L	B24	A24	GND
GND	B25	A25	PCIE_RXP_2_P4L
GND	B26	A26	PCIE_RXN_2_P4L
PCIE_TXP_3_P4L	B27	A27	GND
PCIE_TXN_3_P4L	B28	A28	GND
GND	B29	A29	PCIE_RXP_3_P4L
NC	B30	A30	PCIE_RXN_3_P4L
NC	B31	A31	GND
GND	B32	A32	NC

# 3. Mechanical Drawing



EEV-EX15

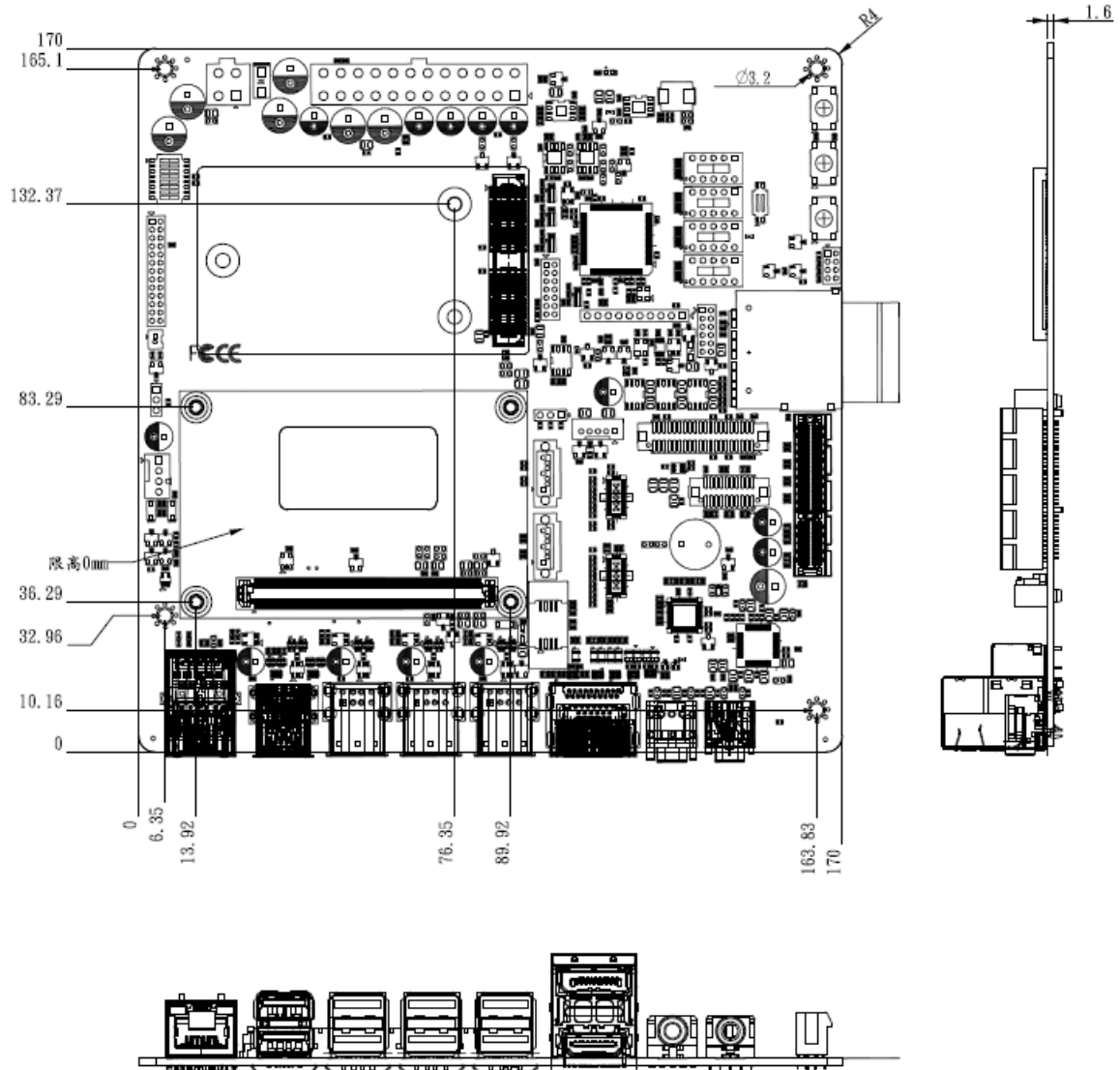

Unit: mm

EEV-EX15 DB-A PCIe Expansion board

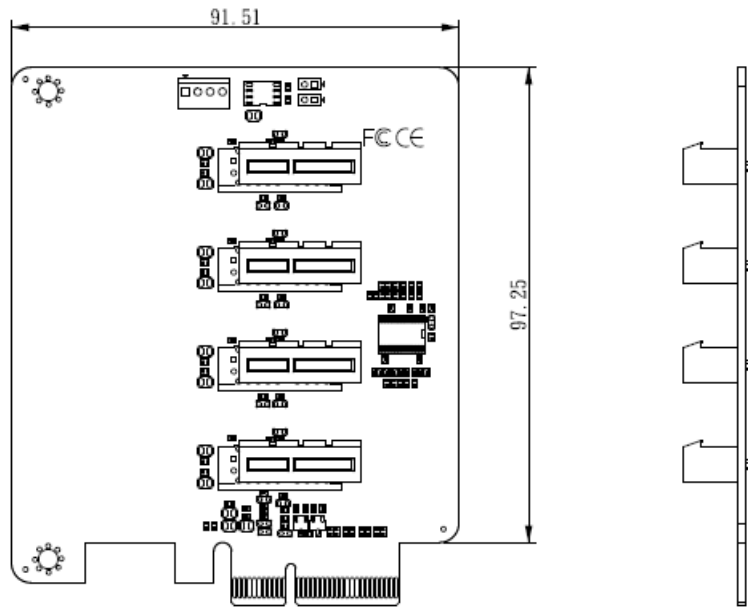

EEV-EX15 DB-B LAN Expansion board

Unit: mm

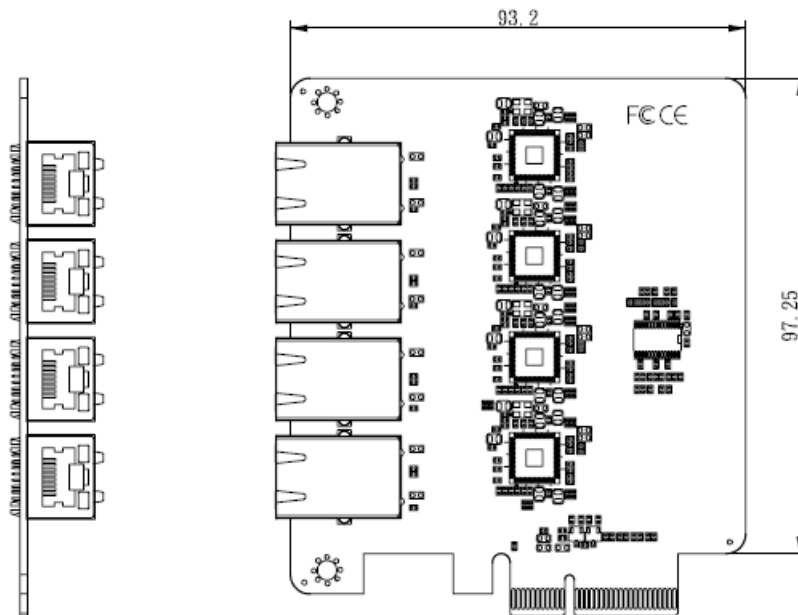

Unit: mm

