

MX170QD

Intel® Q170 mini-ITX Motherboard supports LGA1151 Skylake-S CPU

Mini ITX Motherboard

User's Quick Start Card

Version 1.0

<http://www.bcmcom.com>

• Inspect the Package:

- One **MX170QD Motherboard**
- One **SATA power Cable**
- One **DC-In Power Cable**
- One **I/O Shield**

• Responsibility:

This manual is provided "As-Is" with no warranties of any kind, it will neither expressed or implied, including, but not limited to the implied warranties or conditions of this product's fitness for any particular purpose. In no event shall we be liable for any loss of profits, loss of business, loss of data, interruption of business, or indirect, special, incidental, or consequential damages of any kind, even the possibility of such damages arising from any defect or error in this manual or product. We reserve the right to modify and update the user manual without prior notice.



WARNING: CMOS Battery Damage

Replace your system's CMOS RAM battery only with the identical CR-2032 3V Lithium-Ion coin cell (or equivalent) battery type to avoid risk of personal injury or physical damage to your equipment. Always dispose of used batteries according to the manufacturer's instructions, or as required by the local ordinance (where applicable). The damage due to not following this warning will void your motherboard's manufacturer warranty.

Perchlorate Material- Special Handling May Apply.

See <http://www.dtsc.ca.gov/hazardouswaste/perchlorate/>



ATTENTION: Incorrect BIOS Setup

If you do not know how to handle BIOS setup or how to set it up properly, it is strongly advisable that you do not modify any of the settings than otherwise instructed in the User's Quick Start Card. Even a seemingly small incorrect adjustment or modification in the BIOS setup can render your system unstable or unusable. The incorrect BIOS setup is not covered by your motherboard's manufacturer warranty.

• Additional Information:

Additional information on setting this board up can be found in the User's Manual in the provided CD-ROM. The Online User's Manual and FAQ/Knowledge Base can be found on our website by visiting our website: <http://www.bcmcom.com>. If your question is not answered in our FAQ/Knowledge Base, visit our forums and post your messages or submit a new FAQ through FAQ Submittal form for us to add your question in our FAQ with our answer.

WARNING: Electrostatic Sensitive Device (ESD)

Static electricity can easily damage your motherboard and will void your motherboard warranty. Keep the motherboard and other system components in their anti-static packaging until you are ready to install them. Touch a grounded surface before you remove any system component from its protective anti-static packaging. Unpacking and installation should be done on a grounded, anti-static mat. The operator should be wearing an anti-static wristband, grounded at the same points as the anti-static mat. During configuration and installation touch a grounded surface frequently to discharge any static electrical charge that may have built up in your body. Avoid touching the components when handling the motherboard or a peripheral card. Handle the motherboard and peripheral cards either by the edges or by the peripheral card case-mounting bracket.

WARNING: Misplaced Jumper Damage

Incorrect setting jumpers and connectors may lead to damage to your motherboard and will void your motherboard warranty. Please pay special attention not to connect these headers in wrong directions. **DO NOT** change ANY jumpers while the motherboard has the power!

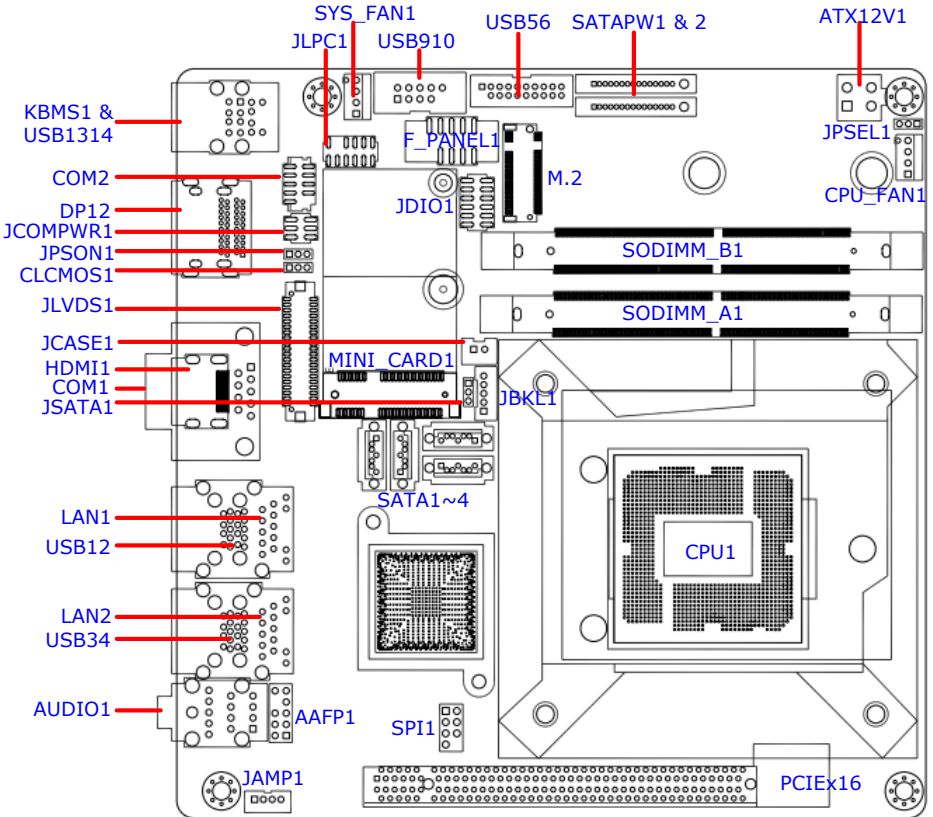

Motherboard Layout:

• Board Layout:

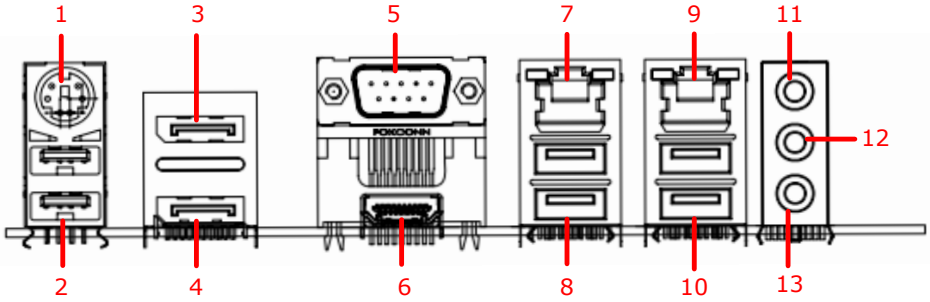

• Back Panel:



| Item | Name | Function | Description | | | | | | | | | | | | | | | | | | | | |
|--------------|---------------|--|---|--------------|--|-----------|--|--------|-------------|--------|-------------|-----|---------|-----|-------------------|--------|--------|-------|--------------------|----------|---------------|--------|------------------|
| 1 | KBMS1 | PS2 Connector | The connector is for PS2 Keyboard or Mouse | | | | | | | | | | | | | | | | | | | | |
| 2 | USB1314 | USB 2.0 Connectors | These two 2-pin Universal Serial Bus (USB) ports are available for connecting USB 2.0 devices. | | | | | | | | | | | | | | | | | | | | |
| 3 | DP1 | Display Port | The display port Connector | | | | | | | | | | | | | | | | | | | | |
| 4 | DP2 | Display Port | The display port Connector | | | | | | | | | | | | | | | | | | | | |
| 5 | COM1 | Serial COM Port | The Serial COM port 1 supports RS-232/422/485 | | | | | | | | | | | | | | | | | | | | |
| 6 | HDMI1 | HDMI port | This HDMI port connector | | | | | | | | | | | | | | | | | | | | |
| 7 | LAN1 | Gigabit LAN (RJ-45) Connectors | This port allows Gigabit connection to a Local Area Network (LAN) through a network hub. Refer to the table below for the LAN port LED indications. | | | | | | | | | | | | | | | | | | | | |
| | | ACT/LINK LED SPEED LED  LAN port | <table border="1"> <thead> <tr> <th colspan="2">ACT/Link LED</th> <th colspan="2">Speed LED</th> </tr> <tr> <th>Status</th> <th>Description</th> <th>Status</th> <th>Description</th> </tr> </thead> <tbody> <tr> <td>OFF</td> <td>No link</td> <td>OFF</td> <td>10Mbps connection</td> </tr> <tr> <td>Orange</td> <td>Linked</td> <td>Green</td> <td>100Mbps connection</td> </tr> <tr> <td>Blinking</td> <td>Data activity</td> <td>Orange</td> <td>1Gbps connection</td> </tr> </tbody> </table> | ACT/Link LED | | Speed LED | | Status | Description | Status | Description | OFF | No link | OFF | 10Mbps connection | Orange | Linked | Green | 100Mbps connection | Blinking | Data activity | Orange | 1Gbps connection |
| ACT/Link LED | | Speed LED | | | | | | | | | | | | | | | | | | | | | |
| Status | Description | Status | Description | | | | | | | | | | | | | | | | | | | | |
| OFF | No link | OFF | 10Mbps connection | | | | | | | | | | | | | | | | | | | | |
| Orange | Linked | Green | 100Mbps connection | | | | | | | | | | | | | | | | | | | | |
| Blinking | Data activity | Orange | 1Gbps connection | | | | | | | | | | | | | | | | | | | | |
| 8 | USB12 | USB 3.0 Connectors | These two 4-pin Universal Serial Bus (USB) ports are available for connecting USB 3.0 devices. | | | | | | | | | | | | | | | | | | | | |
| 9 | LAN2. | Gigabit LAN (RJ-45) Connectors | This port allows Gigabit connection to a Local Area Network (LAN) through a network hub. Refer to the table below for the LAN port LED indications. | | | | | | | | | | | | | | | | | | | | |
| | | ACT/LINK LED SPEED LED  LAN port | <table border="1"> <thead> <tr> <th colspan="2">ACT/Link LED</th> <th colspan="2">Speed LED</th> </tr> <tr> <th>Status</th> <th>Description</th> <th>Status</th> <th>Description</th> </tr> </thead> <tbody> <tr> <td>OFF</td> <td>No link</td> <td>OFF</td> <td>10Mbps connection</td> </tr> <tr> <td>Orange</td> <td>Linked</td> <td>Green</td> <td>100Mbps connection</td> </tr> <tr> <td>Blinking</td> <td>Data activity</td> <td>Orange</td> <td>1Gbps connection</td> </tr> </tbody> </table> | ACT/Link LED | | Speed LED | | Status | Description | Status | Description | OFF | No link | OFF | 10Mbps connection | Orange | Linked | Green | 100Mbps connection | Blinking | Data activity | Orange | 1Gbps connection |
| ACT/Link LED | | Speed LED | | | | | | | | | | | | | | | | | | | | | |
| Status | Description | Status | Description | | | | | | | | | | | | | | | | | | | | |
| OFF | No link | OFF | 10Mbps connection | | | | | | | | | | | | | | | | | | | | |
| Orange | Linked | Green | 100Mbps connection | | | | | | | | | | | | | | | | | | | | |
| Blinking | Data activity | Orange | 1Gbps connection | | | | | | | | | | | | | | | | | | | | |
| 10 | USB34 | USB 3.0 | These two 4-pin Universal Serial Bus (USB) ports | | | | | | | | | | | | | | | | | | | | |

| | | Connectors | are available for connecting USB 3.0 devices. |
|----|--------|------------------------------|---|
| 11 | AUDIO1 | Line-in port (Light blue) | This port connects a tape, CD, DVD player, or other audio sources. |
| 12 | AUDIO1 | Line-out port (Lime) | This port connects a headphone or a speaker. In 4-channel, 6-channel, and 8-channel configuration, the function of this port becomes Front Speaker Out. |
| 13 | AUDIO1 | Microphone port (Pink) | This port connects a microphone. |

Jumpers, Connectors, & Headers:

• Clear CMOS Jumper: CLCMOS1

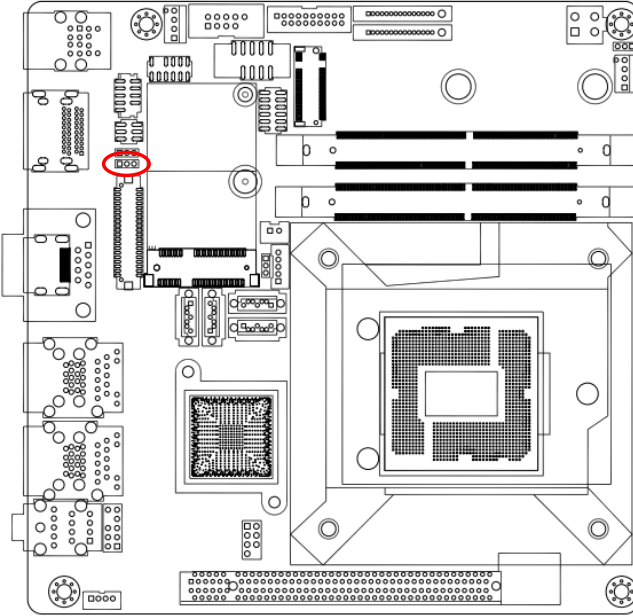

Normal (Default)



1

Clear CMOS



1

DC in voltage Selection: JPSEL1

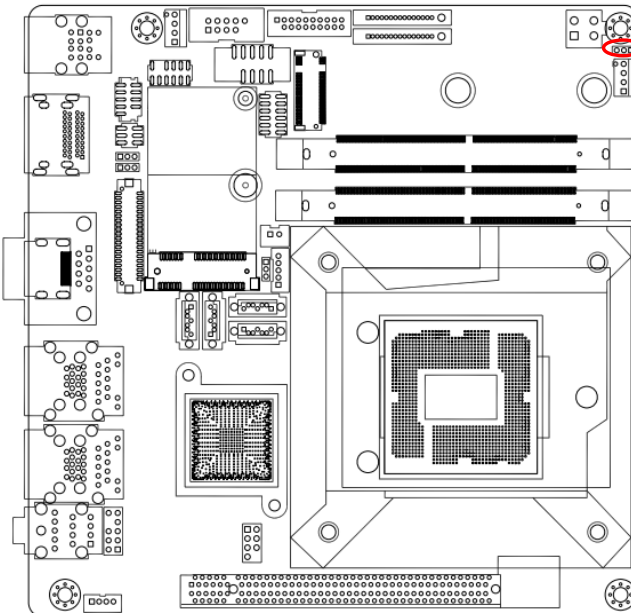

24V



1

12V(Default)



1

• ATX/AT Mode Selection: JPSON1

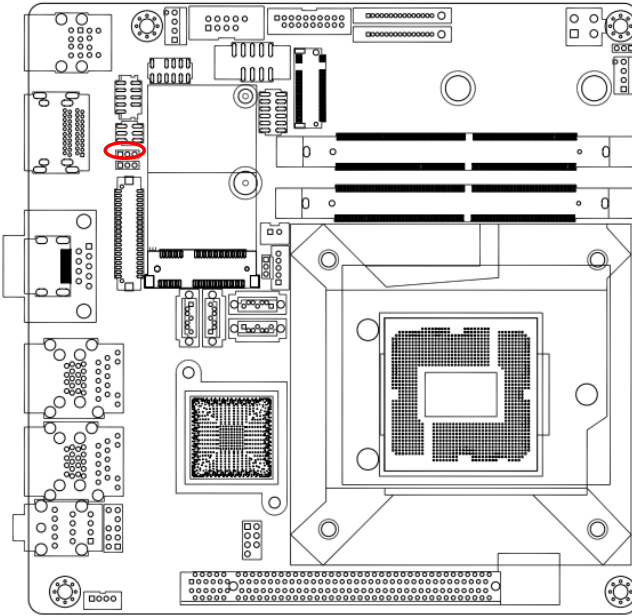

AT mode



1

ATX mode
(Default)



1

• COM1&2 Ring-In/ +12V/ +5V Select: JCOMPWR1

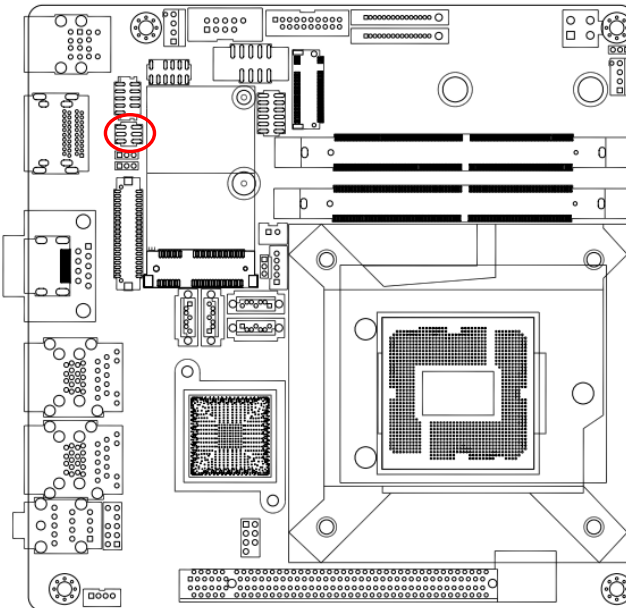

Ring (Default)



1

2

+12V



1

2

+5V



1

2

• mSATA mode Select: JSATA1

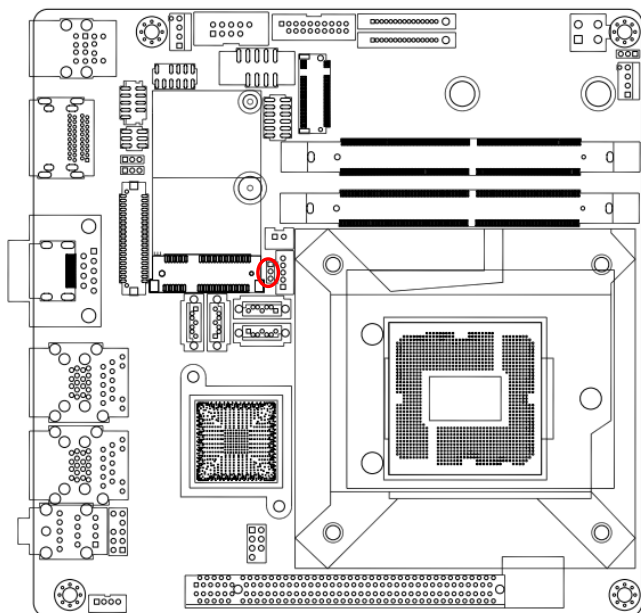

PCIe / Auto
(Default)



Force mSATA



• LVDS panel voltage Selection: JBKLVOL1

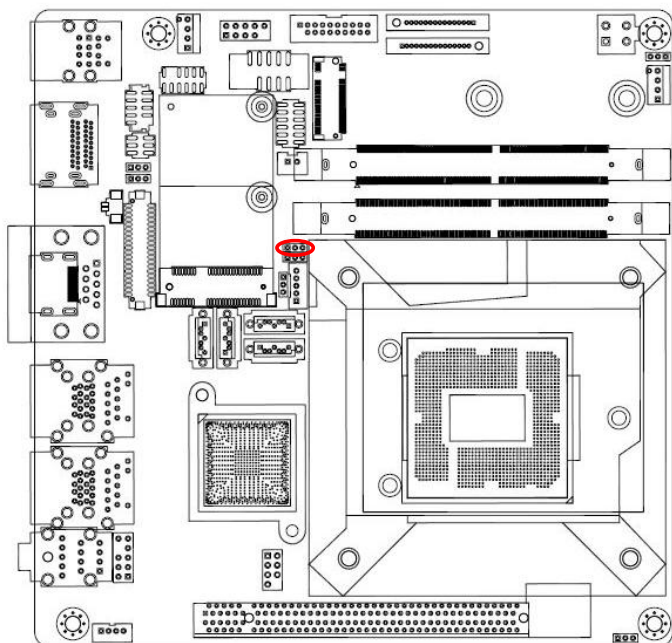

+5V



+3V



• LVDS brightness control mode Selection: JLVD5_BKL1

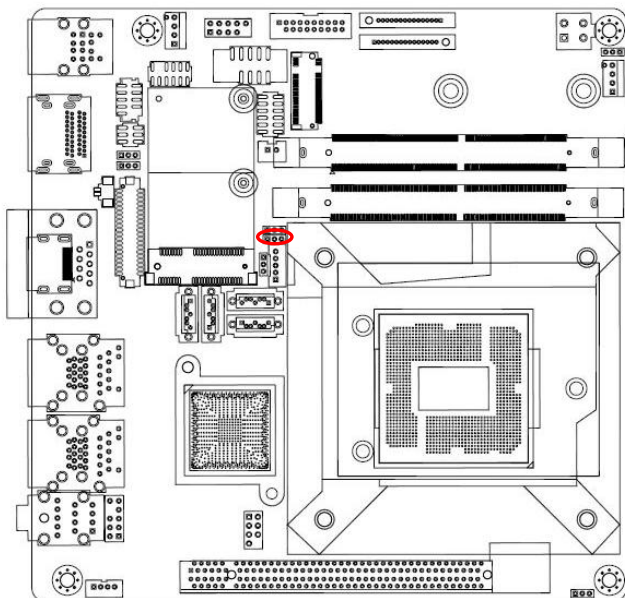

PWM mode



DC mode



• ATX Power Connectors: ATX12V1 (4-pin)

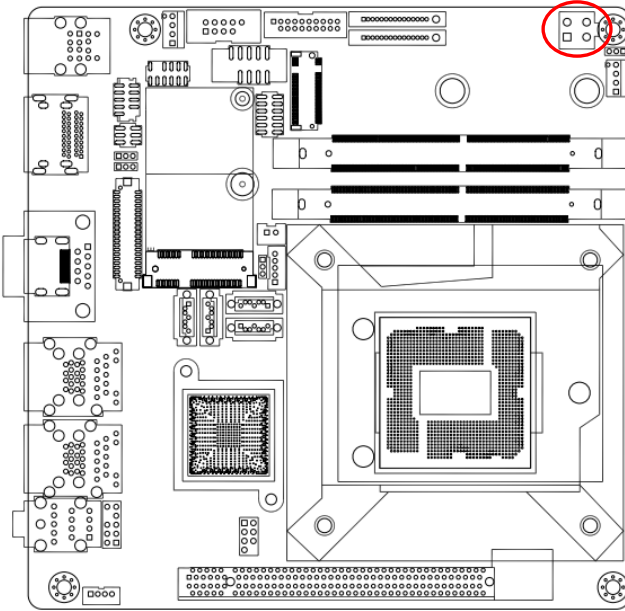

ATX12V1



Fan Connectors: CPU_FAN1, SYS_FAN1

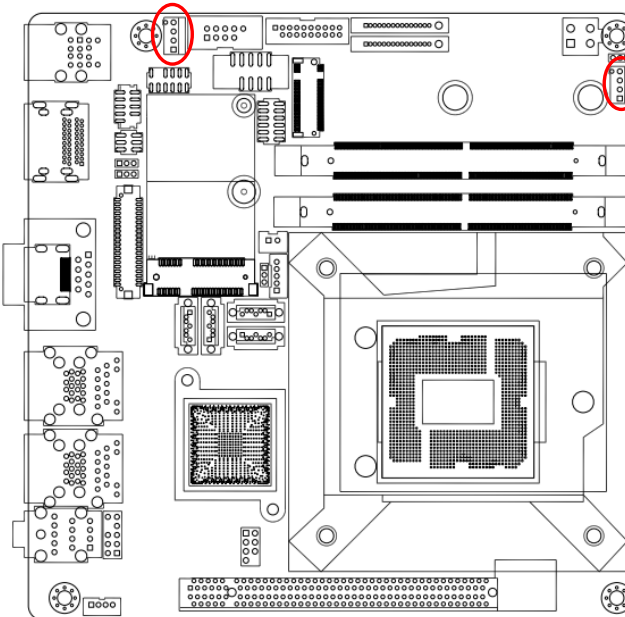

CPU_FAN1

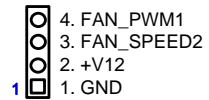

SYS_FAN1

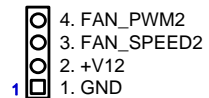

• Serial Port Connectors: COM2

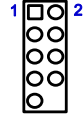
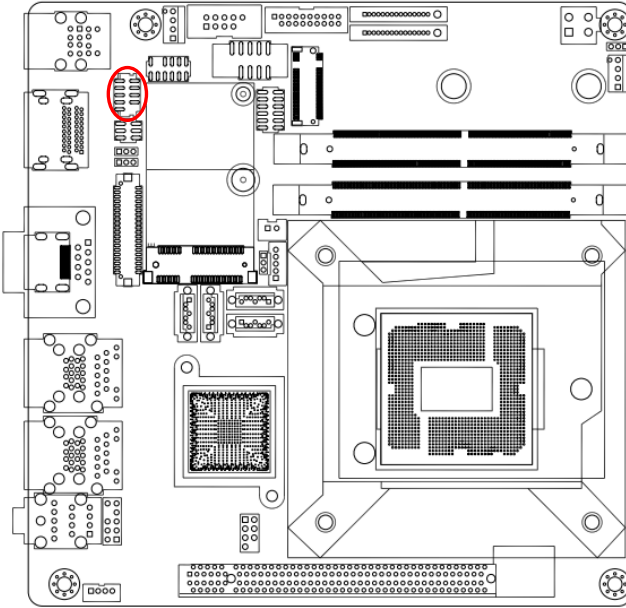

- | | |
|------------------|---------|
| 1. DCD# | 2. RX |
| 3. TX | 4. DTR# |
| 5. GND | 6. DSR# |
| 7. RTS# | 8. CTS# |
| 9. RI3xPOWERxJMP | |

• SATA 3.0 Ports: SATA1, SATA2, SATA3, SATA4

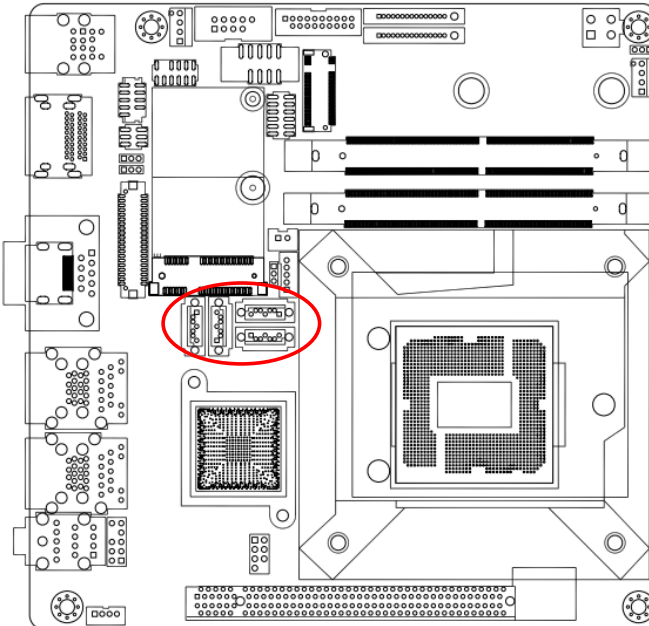

SATA



1. GND
2. TX+
3. TX-
4. GND
5. RX-
6. RX+
7. GND

SATA power connectors: SATAPW1, SATAPW2

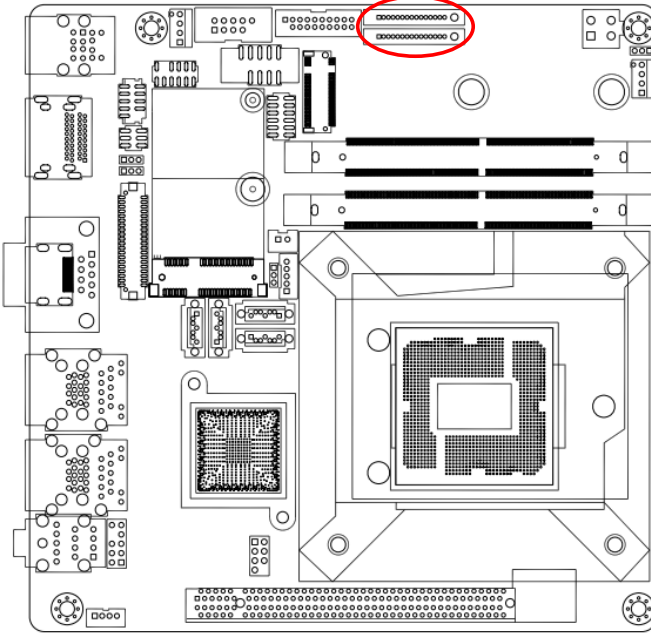

- | | |
|----|-------|
| 1 | +3.3V |
| 2 | +3.3V |
| 3 | +3.3V |
| 4 | GND |
| 5 | GND |
| 6 | GND |
| 7 | +5V |
| 8 | +5V |
| 9 | +5V |
| 10 | GND |
| 11 | GND |
| 12 | GND |
| 13 | +12V |
| 14 | +12V |
| 15 | +12V |

• Front USB 3.0 Headers: USB56

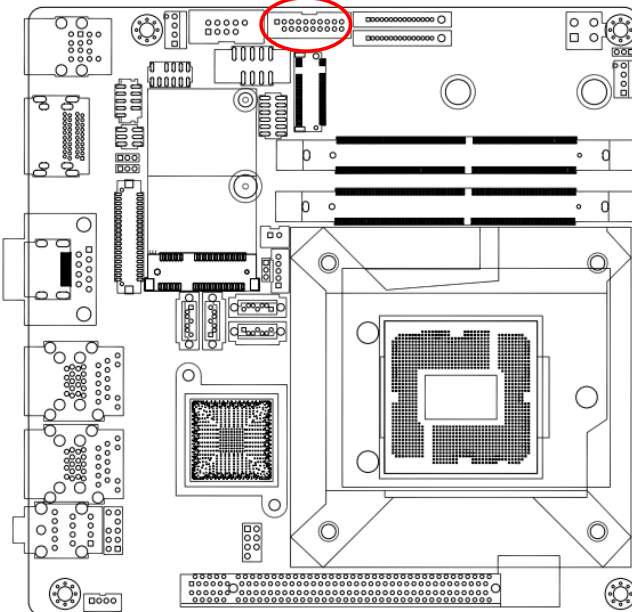

USB56

- | | | | | | |
|----|---|----|----------|----|----------|
| 19 | 1 | 19 | +5V | 1 | +5V |
| | | 18 | USB3_RX- | 2 | USB3_RX- |
| | | 17 | USB3_RX+ | 3 | USB3_RX+ |
| | | 16 | GND | 4 | GND |
| | | 15 | USB3_TX- | 5 | USB3_TX- |
| | | 14 | USB3_TX+ | 6 | USB3_TX+ |
| | | 13 | GND | 7 | GND |
| | | 12 | USB- | 8 | USB- |
| | | 11 | USB+ | 9 | USB+ |
| | | | | 10 | NC |

• Front USB 2.0 Headers: USB910

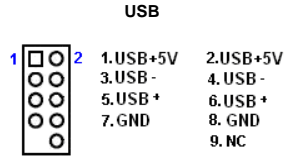
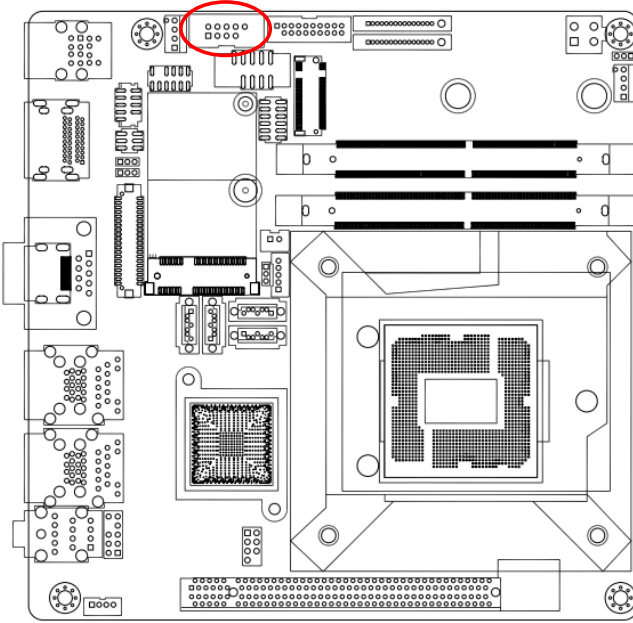

• Front Panel Connector: F_PANEL1

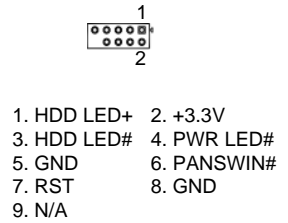
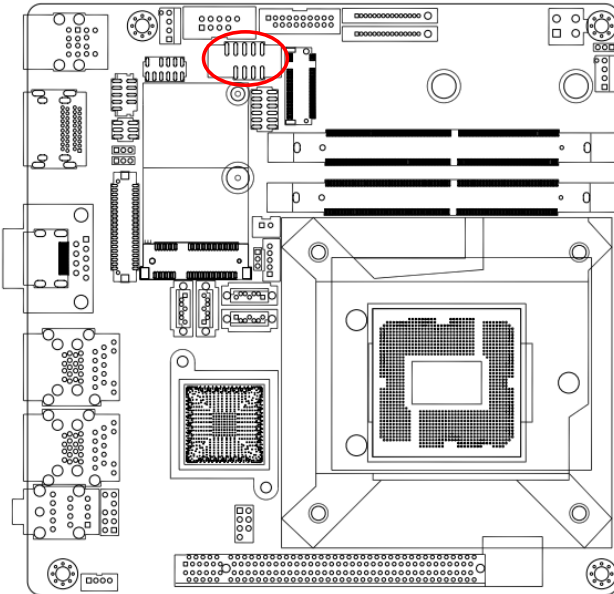

• Front Panel Audio Connector: AAFP1

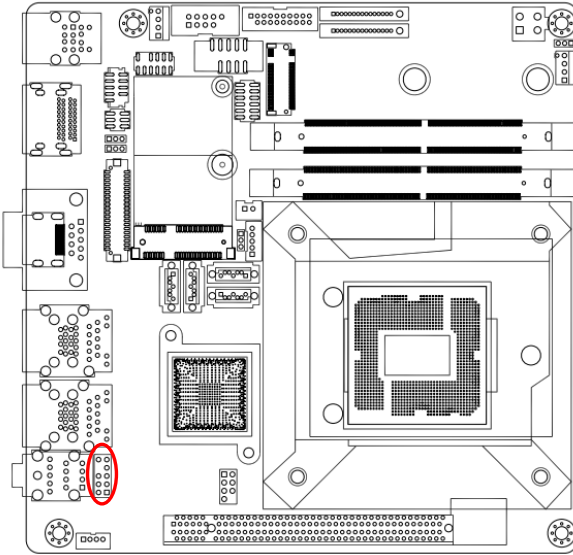

- | | |
|--------------|-----------|
| 10. LINE2-JD | 9. LINE2L |
| 8. NC | 7. SENSEB |
| 6. MIC2-JD | 5. LINE2R |
| 4. NC | 3. MIC2R |
| 2. GND | 1. MIC2L |

• Amplifier Connector: JAMP1

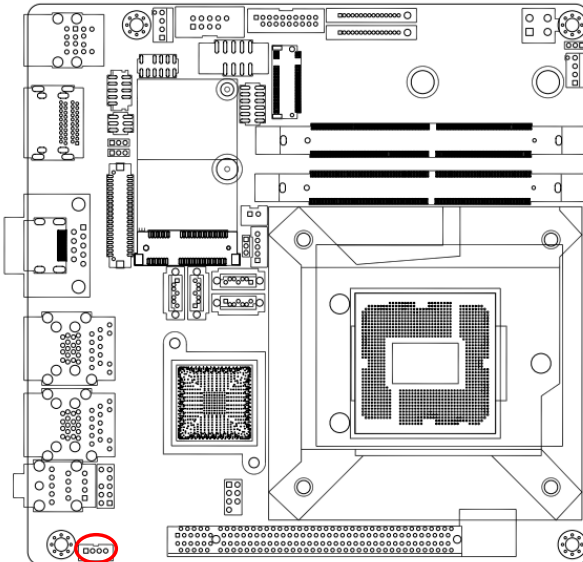

- | |
|-----------|
| 1. AMP_L- |
| 2. AMP_L+ |
| 3. AMP_R- |
| 4. AMP_R+ |

• Digital I/O Connector: JDIO1

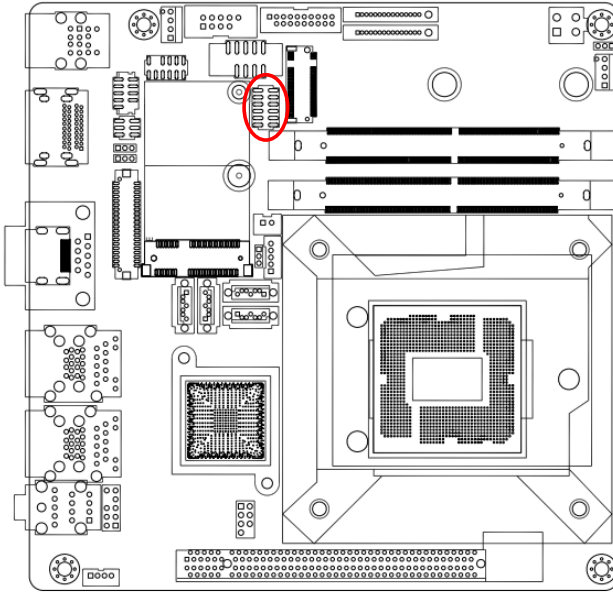

- | | |
|--------------|---------------|
| 1. SIO_GPIO0 | 2. SIO_GPIO4 |
| 3. SIO_GPIO1 | 4. SIO_GPIO5 |
| 5. SIO_GPIO2 | 6. SIO_GPIO6 |
| 7. SIO_GPIO3 | 8. SIO_GPIO7 |
| 9. SMB_CLK_ | 10. SMB_DATA_ |
| RESUME | RESUME |
| 11. GND | 12. +5Vsb |

• LVDS panel connector: JLVDS1

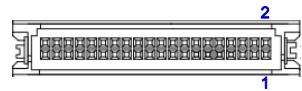
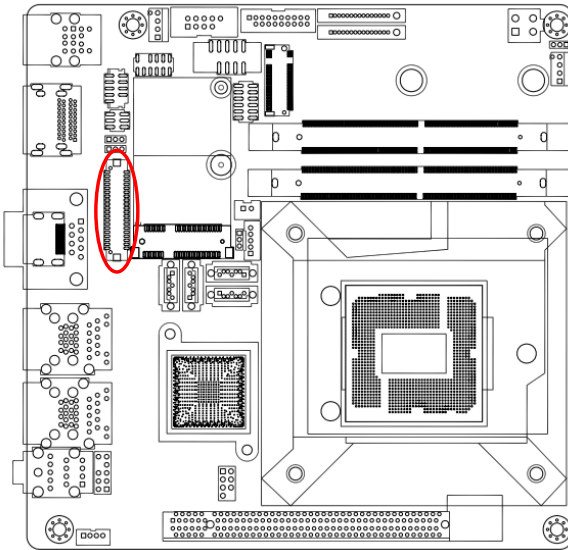

- | | |
|-----------------|-----------------|
| 39. VDD_+12V | 40. VDD_+12V |
| 37. GND | 38. GND |
| 35. LVDS_B_CLK- | 36. LVDS_A_CLK- |
| 33. LVDS_B_CLK+ | 34. LVDS_A_CLK+ |
| 31. GND | 32. GND |
| 29. LVDS_B3- | 30. LVDS_B2- |
| 27. LVDS_B3+ | 28. LVDS_B2+ |
| 25. GND | 26. GND |
| 23. LVDS_B1- | 24. LVDS_B0- |
| 21. LVDS_B1+ | 22. LVDS_B0+ |
| 19. GND | 20. GND |
| 17. LVDS_A3- | 18. LVDS_A2- |
| 15. LVDS_A3+ | 16. LVDS_A2+ |
| 13. GND | 14. GND |
| 11. LVDS_A1- | 12. LVDS_A0- |
| 9. LVDS_A1+ | 10. LVDS_A0+ |
| 7. GND | 8. GND |
| 5. DDC_CLK | 6. DDC_DATA |
| 3. VDD_+3.3V | 4. VDD_+5V |
| 1. VDD_+3.3V | 2. VDD_+5V |

• LVDS panel backlight connector: JBKL1

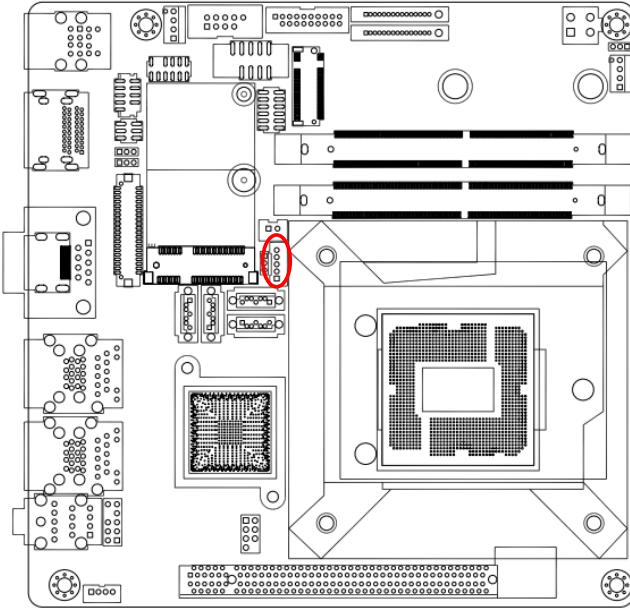

1. +12V_BL
2. GND
3. BL_EN
4. BRIGHT1
5. +5V_BL

•Chassis Intrusion Connector: JCASE1

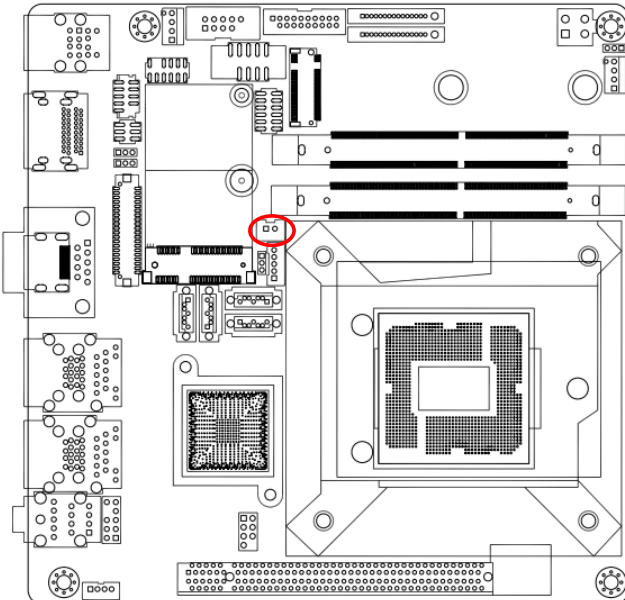

1. SIO_CASEOPEN#
2. GND

• SM Bus connector: JSMB1

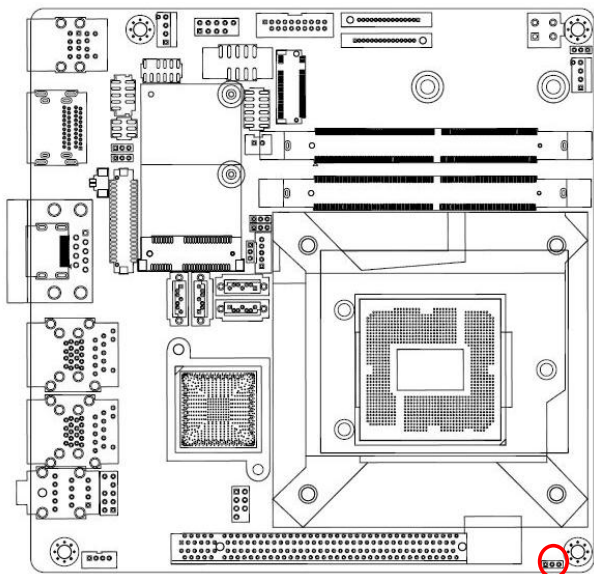

1. SMBCLK
2. SMBDATA
3. GND