

EPC-TGU

Intel® 11th Gen Tiger Lake Fanless Tiny System

Quick Reference Guide

3rd Ed – 17 January 2023

Copyright Notice

Copyright © 2023, ALL RIGHTS RESERVED.

FCC Statement



THIS DEVICE COMPLIES WITH PART 15 FCC RULES. OPERATION IS SUBJECT TO THE FOLLOWING TWO CONDITIONS:

(1) THIS DEVICE MAY NOT CAUSE HARMFUL INTERFERENCE.

(2) THIS DEVICE MUST ACCEPT ANY INTERFERENCE RECEIVED INCLUDING INTERFERENCE THAT MAY CAUSE UNDESIRE OPERATION.

THIS EQUIPMENT HAS BEEN TESTED AND FOUND TO COMPLY WITH THE LIMITS FOR A CLASS "A" DIGITAL DEVICE, PURSUANT TO PART 15 OF THE FCC RULES.

THESE LIMITS ARE DESIGNED TO PROVIDE REASONABLE PROTECTION AGAINST HARMFUL INTERFERENCE WHEN THE EQUIPMENT IS OPERATED IN A COMMERCIAL ENVIRONMENT. THIS EQUIPMENT GENERATES, USES, AND CAN RADIATE RADIO FREQUENCY ENERGY AND, IF NOT INSTALLED AND USED IN ACCORDANCE WITH THE INSTRUCTION MANUAL, MAY CAUSE HARMFUL INTERFERENCE TO RADIO COMMUNICATIONS.

OPERATION OF THIS EQUIPMENT IN A RESIDENTIAL AREA IS LIKELY TO CAUSE HARMFUL INTERFERENCE IN WHICH CASE THE USER WILL BE REQUIRED TO CORRECT THE INTERFERENCE AT HIS OWN EXPENSE.

A Message to the Customer

Customer Services

Each and every product is built to the most exacting specifications to ensure reliable performance in the harsh and demanding conditions typical of industrial environments. Whether your new device is destined for the laboratory or the factory floor, you can be assured that your product will provide the reliability and ease of operation.

Your satisfaction is our primary concern. Here is a guide to our customer services. To ensure you get the full benefit of our services, please follow the instructions below carefully.

Technical Support

We want you to get the maximum performance from your products. So if you run into technical difficulties, we are here to help. For the most frequently asked questions, you can easily find answers in your product documentation. These answers are normally a lot more detailed than the ones we can give over the phone. So please consult the user's manual first.

Content

1. Getting Started	5
1.1 Safety Precautions	5
1.2 Packing List	5
1.3 System Specifications	6
1.4 System Overview.....	10
1.4.1 Front View.....	10
1.4.2 Rear View	10
1.5 System Dimensions.....	12
1.5.1 Front & Top View	12
2. Hardware Configuration	13
2.1 EPC-TGU connector mapping	14
2.1.1 Serial port 1/2 connector (COM1/2).....	14
2.2 Installing Hard Disk & Memory (EPC-TGU).....	15
2.3 Installing M.2 B-Key (2242)/ (3042) card (EPC-TGU).....	17
2.4 Installing M.2 E-Key card (EPC-TGU)	18
2.5 Installing M.2 M-Key (2242) card (EPC-TGU)	19
2.6 Installing Mounting Brackets (EPC-TGU)	20
3. BIOS Setup	21
3.1 Introduction.....	22
3.2 Starting Setup.....	22
3.3 Using Setup	23
3.4 Getting Help.....	24
3.5 In Case of Problems	24
3.6 BIOS setup	25
3.6.1 Main Menu	25
3.6.1.1 System Language	26
3.6.1.2 System Date	26
3.6.1.3 System Time	26
3.6.2 Advanced Menu.....	26
3.6.2.1 Connectivity Configuration	27
3.6.2.2 CPU Configuration	28
3.6.2.3 Power & Performance	29
3.6.2.3.1 CPU – Power Management Control.....	29
3.6.2.4 PCH-FW Configuration.....	30
3.6.2.4.1 Firmware Update Configuration	30

EPC-TGU

3.6.2.5	Trusted Computing.....	31
3.6.2.6	APCI Settings	31
3.6.2.7	Super IO Configuration.....	32
3.6.2.7.1	Serial Port 1 Configuration	33
3.6.2.7.2	Serial Port 2 Configuration	33
3.6.2.8	HW Monitor	34
3.6.2.9	S5 RTC Wake Settings	34
3.6.2.10	Serial Port Console Redirection	35
3.6.2.10.1	Legacy Console Redirection Settings	36
3.6.2.11	USB Configuration.....	36
3.6.2.12	Network Stack Configuration.....	37
3.6.2.13	NVMe Configuration	38
3.6.3	Chipset.....	45
3.6.3.1	System Agent (SA) Configuration	46
3.6.3.1.1	Memory Configuration	46
3.6.3.1.2	VMD setup menu.....	47
3.6.3.2	PCH-IO Configuration	47
3.6.3.2.1	PCI Express Configuration.....	48
3.6.3.2.1.1	PCI Express Root Port 6(M.2 KeyE).....	48
3.6.3.2.1.2	PCI Express Root Port 7(LAN2-I210).....	49
3.6.3.2.1.3	PCI Express Root Port 8(LAN3-I225).....	50
3.6.3.2.1.4	PCI Express Root Port 12(M.2 KeyB).....	51
3.6.3.2.2	SATA And RST Configuration	52
3.6.3.2.3	HD Audio Configuration	53
3.6.3.3	Board & Panel Configuration.....	53
3.6.3.3.1	SHOW DMI INFO	54
3.6.4	Security.....	55
3.6.4.1	Secure Boot.....	56
3.6.4.1.1	Key Management	57
3.6.5	Boot.....	57
3.6.6	Save and exit	58
3.6.6.1	Save Changes and Reset	59
3.6.6.2	Discard Changes and Reset	59
3.6.6.3	Restore Defaults.....	59
3.6.6.4	Launch EFI Shell from filesystem device	59

1. Getting Started

1.1 Safety Precautions

Warning!



Always completely disconnect the power cord from your chassis whenever you work with the hardware. Do not make connections while the power is on. Sensitive electronic components can be damaged by sudden power surges. Only experienced electronics personnel should open the PC chassis.

Caution!



Always ground yourself to remove any static charge before touching the CPU card. Modern electronic devices are very sensitive to static electric charges. As a safety precaution, use a grounding wrist strap at all times. Place all electronic components in a static-dissipative surface or static-shielded bag when they are not in the chassis.

1.2 Packing List

- 1 x EPC-TGU Intel Core SoC Processor Fanless Box PC
- Other major components include the followings:
 - 1 x AC to DC Adapter
 - 1 x Table Stand
 - 1 x Screw kits
 - 1 x M.2 2260 to 2242 Bracket
 - 1 x M.2 2252 to 2242 Bracket
 - 4 x Rubber Foot
 - 2 x Mounting Kit
 - 1 x DP to VGA Converter



If any of the above items is damaged or missing, contact your retailer.

1.3 System Specifications

System	
Processor	Intel® Core™ i7-1185G7E Processor (15W, 12M Cache, 1.8 up to 4.40 GHz) Intel® Core™ i5-1145G7E Processor (15W, 8M Cache, 1.5 up to 4.10GHz) Intel® Core™ i3-1115G4E Processor (15W, 6M Cache, 2.2 up to 3.90GHz) Intel® Celeron® 6305E Processor (15W, 4M Cache, 1.80GHz)
System Memory	1 x 260-Pin SO-DIMM Socket, Max. Up to 32GB DDR4 3200MHz
I/O Chipset	EC ITE IT8882
BIOS Information	AMI uEFI BIOS, 256Mbit SPI Flash ROM
Watchdog Timer	H/W Reset, 1sec. ~ 65535sec.
H/W Status Monitor	Monitoring System Temperature and Voltage with Auto Throttling Control
RAID	SATA RAID 0/1
TPM	TPM 2.0
iAMT	Above Core i5 (selected SKUs)
SBC	ECM-TGU
Expansion	
M.2 (Key-X, Size, Signal)	1 x M.2 Key-M 2242 (PCIe Gen4 x 4) 1 x M.2 Key-B 2242/3042 with Internal SIM Slot (SATA, USB 2.0) 1 x M.2 Key-E 2230 (PCIe, USB 2.0)
Storage	
M.2 (Key-X, Size, Signal)	1 x M.2 Key-M 2242 NVMe (PCIe Gen4 x 4) 1 x M.2 Key-B 2242/3042 (SATA)
2.5" Drive Bay (Height)	1 x Internal 2.5" Drive Bay (7mm)
Edge I/O (Front)	
COM Port	2 x RS232/422/485 (BIOS)
Power Button	1 x Power On/Off
LED Indicator	1 x Power On/Off 1 x Storage Access
Edge I/O (Rear)	
USB Port	2 x USB 2.0 (via cable) 4 x USB 3.1 Gen.2 (10Gbp/s)
DP	2 x DP++

Audio	1 x Combo Jack (Mic-In + Line-Out)			
RJ-45	2 x RJ45 (Max. Up to 3-RJ45 in project base)			
LED Indicator	1 x Power On/Off 1 x Storage Access			
Antenna	2 x Antenna Mounting with Dust Protection Cover			
Display				
Graphic Chipset	Intel® Iris® Xe Graphics (i7-1185G7E/ i5-1145G7E)			
Resolution	DP++ 1.4: 4096x2304@60Hz DP1+DP2 (DP1.4): Max: 7680 x 4320@60 Hz			
Ethernet				
LAN Chipset	Intel® Ethernet Controller I225-LM Intel® Ethernet Controller I210-AT			
Specification	10/100/1000/2.5 Gigabit (I225-LM) 10/100/1000 Gigabit (I210-AT)			
LED Indicator	Max. 1G LAN Port			
	ACT/LINK		SPEED	
	LED	Definition	LED	Definition
	Light Off	No Link	Solid Orange	1G
	Solid Yellow	Connection	Solid Green	100M
	Yellow Flashing	Activity	Light Off	10M
	Max. 2.5G LAN Port			
	ACT/LINK		SPEED	
	LED	Definition	LED	Definition
	Light Off	No Link	Solid Orange	2.5G
Solid Yellow	Connection	Solid Green	1G/100M	
Yellow Flashing	Activity	Light Off	10M	
Power Requirement				
DC Input	Typical 12/24Vdc			
DC Input Connector	Lockable DC Jack			
ACPI	Single power ATX Support S0, S3, S4, S5 ACPI 5.0 Compliant			
Power Mode	AT/ATX (ATX is default setting)			
Adapter	AC to DC Adapter			
Mechanical & Environment				
Operating Temp.	With extended temperature peripherals: 0°C ~ 50°C (14°F ~ 122°F) with 0.5m/s air flow			
Storage Temp.	-20°C ~ 60°C (-4°F ~ 140°F)			

EPC-TGU

Operating Humidity	40°C @ 95% Relative Humidity, Non-condensing
Dimension (W*L*H)	177 x 123 x 55 mm (7" x 4.8" x 2.2")
Weight	1.2KG (2.65lbs)
Vibration Test	<p>Random Vibration Operation</p> <ol style="list-style-type: none"> 1 Test PSD : 0.0505G²/Hz , 5 Grms 2 System condition : operation mode 3 Test frequency : 5~500 Hz 4 Test axis : X,Y and Z axis 5 Test time : 30 minutes per each axis 6 IEC60068-2-64 Test Fh 6 Storage : SSD <p>Sine Vibration test (Non-operation)</p> <ol style="list-style-type: none"> 1 Test Acceleration : 2G 2 Test frequency : 5~500 Hz 3 Sweep : 1 Oct/ per one minute. (logarithmic) 4 Test Axis : X,Y and Z axis 5 Test time :30 min. each axis 6 System condition : Non-Operating mode 7. Reference IEC 60068-2-6 Testing procedures <p>Package Vibration Test:</p> <ol style="list-style-type: none"> 1 Test PSD : 0.026G²/Hz , 2.16 Grms 2 Test frequency : 5~500 Hz 3 Test axis : X,Y and Z axis 4 Test time : 30 minutes per each axis 5 IEC 60068-2-64 Test Fh
Shock Test	<ol style="list-style-type: none"> 1 Wave from : Half Sine wave 2 Acceleration Rate : 55G 3 Duration Time : 11ms 4 No. of shock : 3 times 5 Test Axis : +/- X, +/-Y, +/-Z axis 6 operation mode 7 Reference IEC 60068-2-27 testing procedures <p>Test Eb : SSD Shock Test</p>
Drop Test	<p>Package drop test</p> <p>Reference ISTA 2A, Method : IEC-60068-2-32 Test:Ed</p> <p>Test Ea : Drop Test</p>

	<p>1 Test phase : One corner, three edges, six faces</p> <p>2 Test high : 96.5cm</p> <p>3 Package weight : 5Kg</p> <p>4 Test drawing</p>
Mounting Kit	<p>Table Stand</p> <p>Wall mount bracket</p>
Software Support	
OS Information	Win10, Win11, Linux
Certification	
Certification Information	CE, FCC Class B
In-Box Accessory	
Accessory	<p>1 x AC to DC Adapter</p> <p>1 x Table Stand</p> <p>1 x Screw kits</p> <p>1 x M.2 2260 to 2242 Bracket</p> <p>1 x M.2 2252 to 2242 Bracket</p> <p>4 x Rubber Foot</p> <p>2 x Mounting Kit</p> <p>1 x DP to VGA Converter</p>



Note: Specifications are subject to change without notice.

1.4 System Overview

1.4.1 Front View

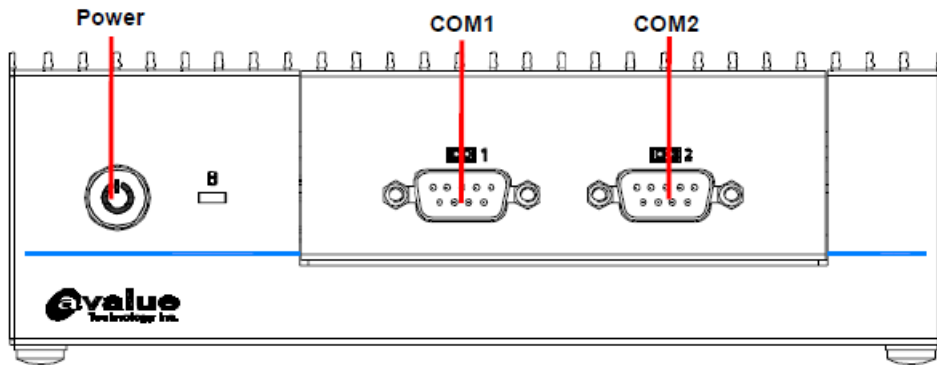

Connectors

Label	Function	Note
Power	Power on button	
COM1/2	Serial port 1/2 connector	

1.4.2 Rear View

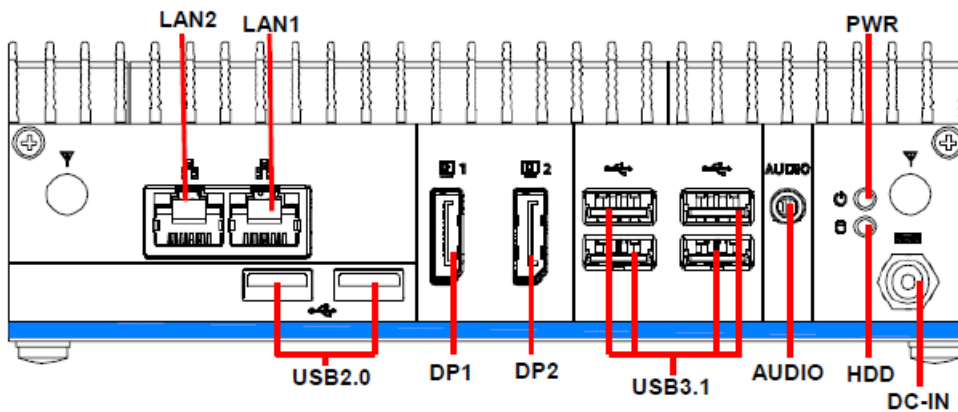

Connectors

Label	Function	Note
HDD	HDD indicator	
PWR	System power indicator	
LAN1/2	RJ-45 Ethernet x 2	
USB3.1	USB 3.1 connector x 4	

USB2.0	USB 2.0 connector x 2	
DC-IN	DC Power-in connector	
DP1/2	DP connector x 2	
Audio	Audio connector	Mic-In + Line-Out

1.5 System Dimensions

1.5.1 Front & Top View

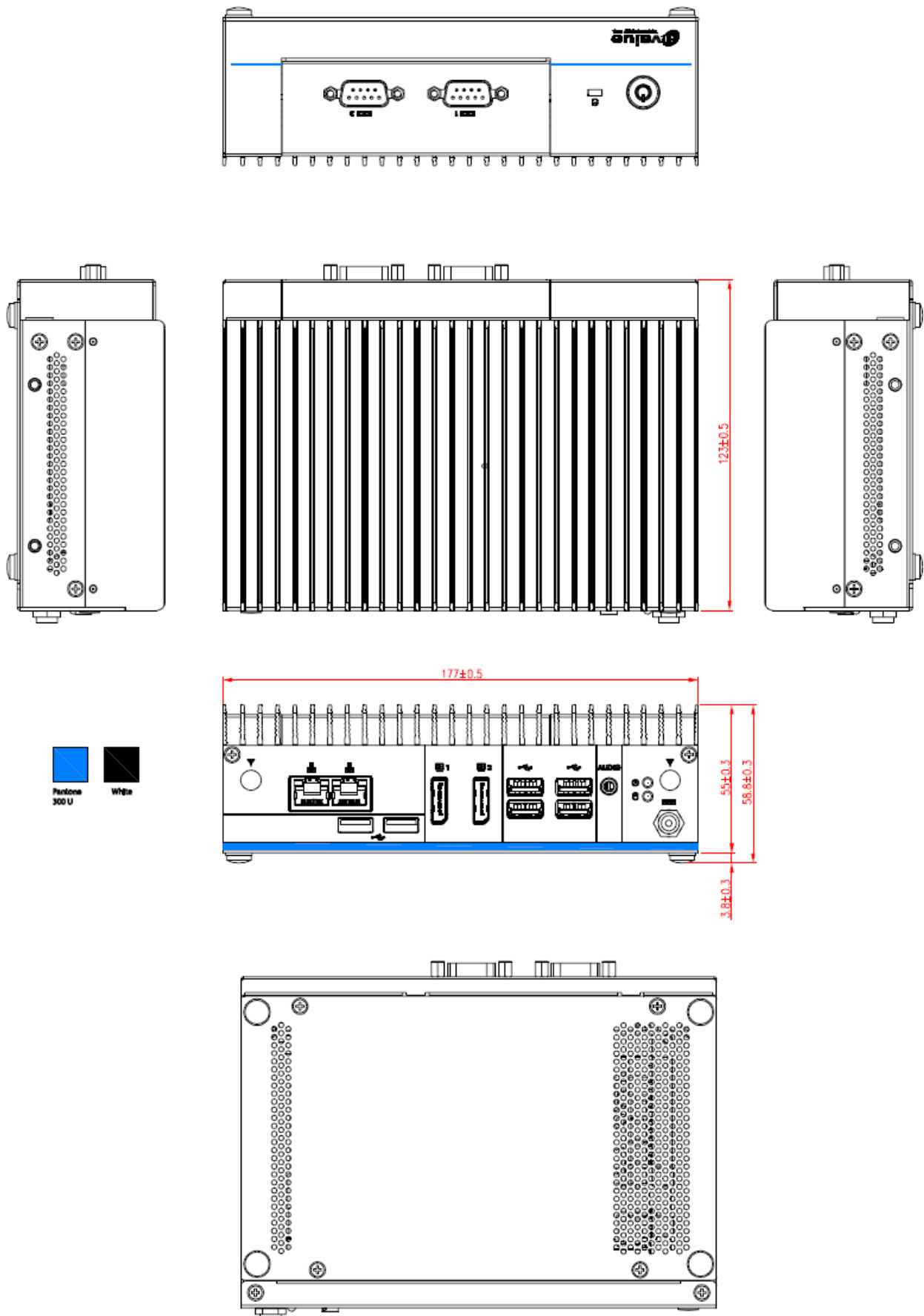

(Unit: mm)

2. Hardware Configuration

For advanced information, please refer to:

- 1- ECM-TGU User's Manual

2.1 EPC-TGU connector mapping

2.1.1 Serial port 1/2 connector (COM1/2)

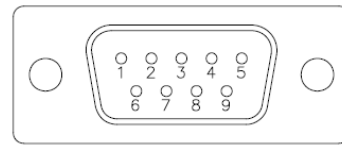
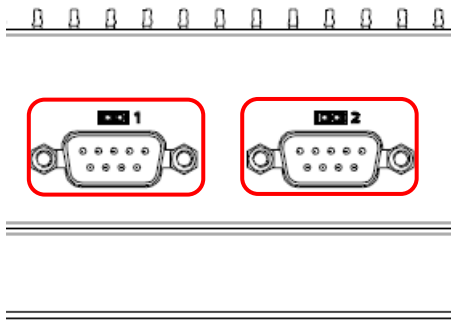

RS-485

Signal	PIN	PIN	Signal
485_Tx-	1	6	NC
485_Tx+	2	7	NC
NC	3	8	NC
NC	4	9	NC
GND	5		

RS-232

Signal	PIN	PIN	Signal
DCD#	1	6	DSR#
RXD	2	7	RTS#
TXD	3	8	CTS#
DTR#	4	9	RI#
GND	5		

RS-422

Signal	PIN	PIN	Signal
422_Tx-	1	6	NC
422_Tx+	2	7	NC
422_Rx+	3	8	NC
422_Rx-	4	9	NC
GND	5		

2.2 Installing Hard Disk & Memory (EPC-TGU)

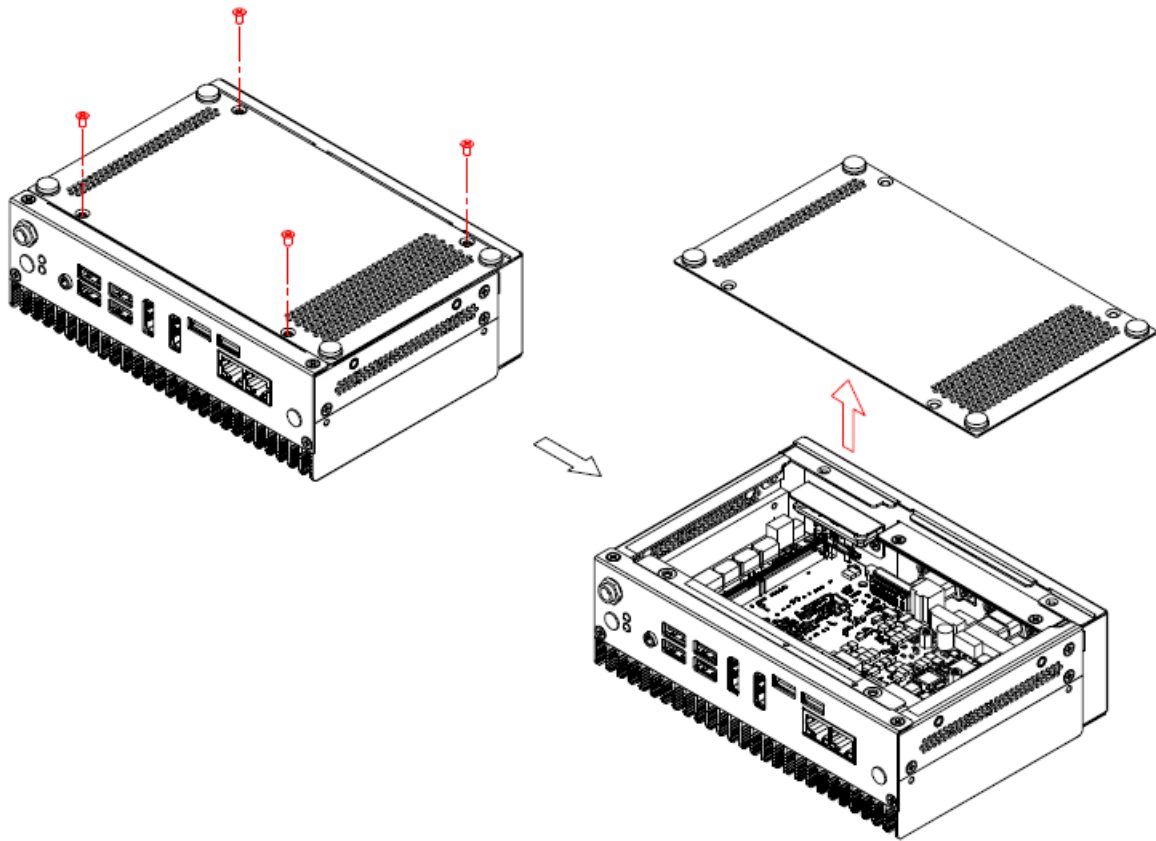

Step1. For HDD installation, remove four M3*5L screws from bottom cover.

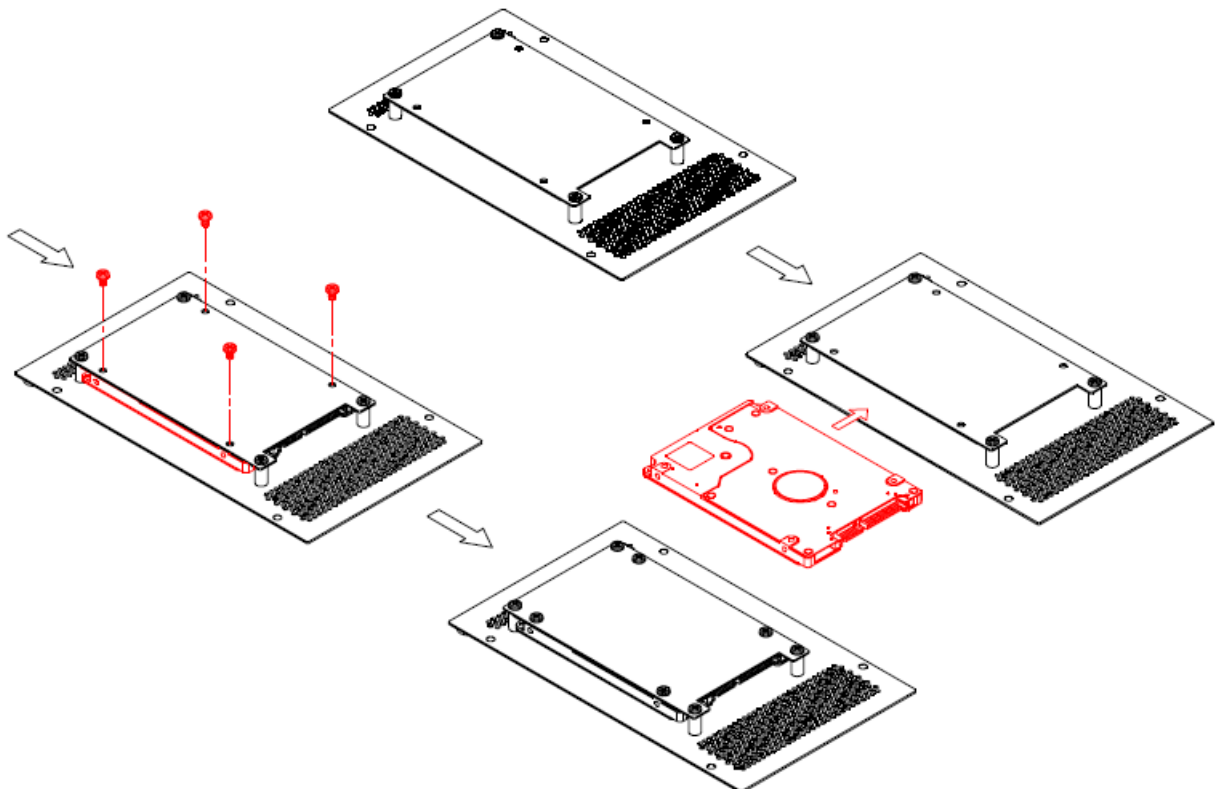

Step2. Install HDD.

Step3. Fix HDD with four M3*4 screws.

EPC-TGU

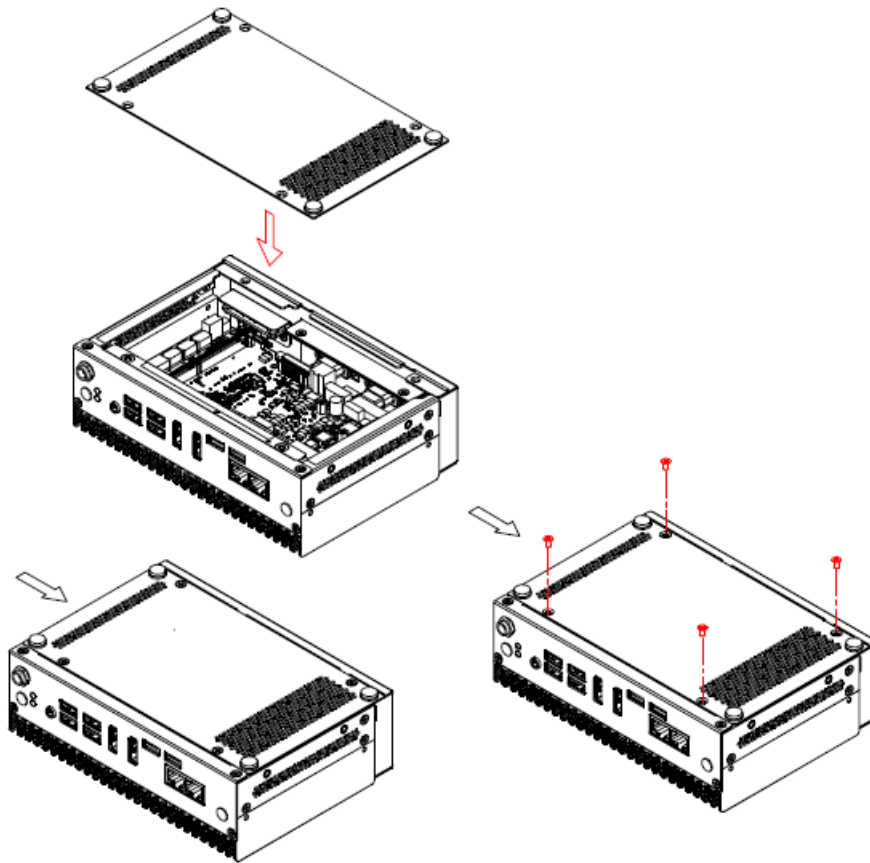

Step4. Put the bottom back and fix with four M3*5 screws.

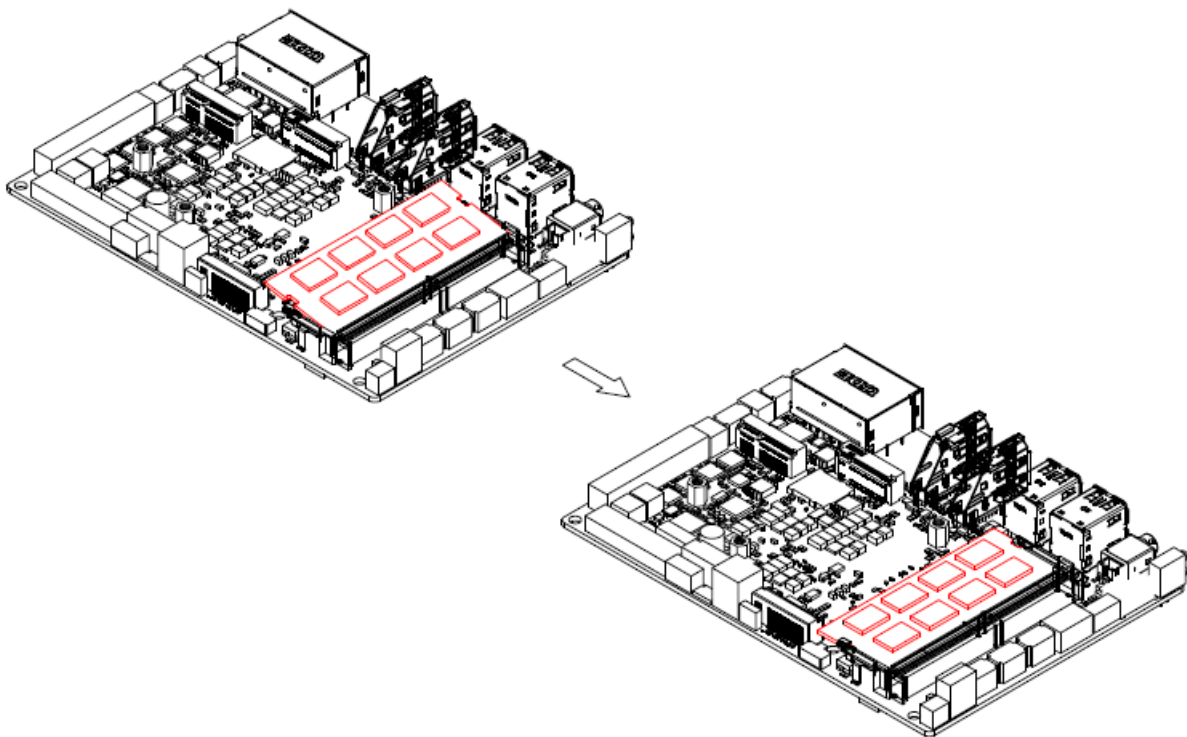

Step5. Slide the DDR4 SODIMM into the memory socket and press it down until properly seated.

2.3 Installing M.2 B-Key (2242)/ (3042) card (EPC-TGU)

B-KEY(2242/3042)

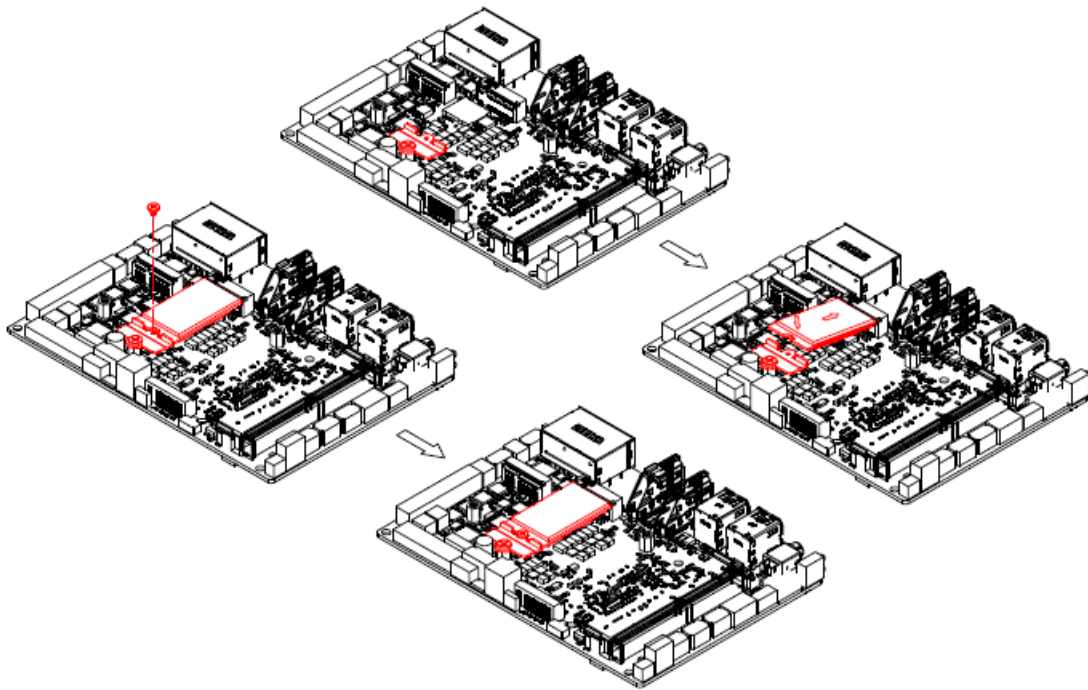

Step1. Fix bracket (16.6*22) and standoff screw with M3*4 screw.

Step2. Insert M.2 B-Key (2242)/ (3042) card into designated locations and fasten with M2*3 screw to complete installation.

2.4 Installing M.2 E-Key card (EPC-TGU)

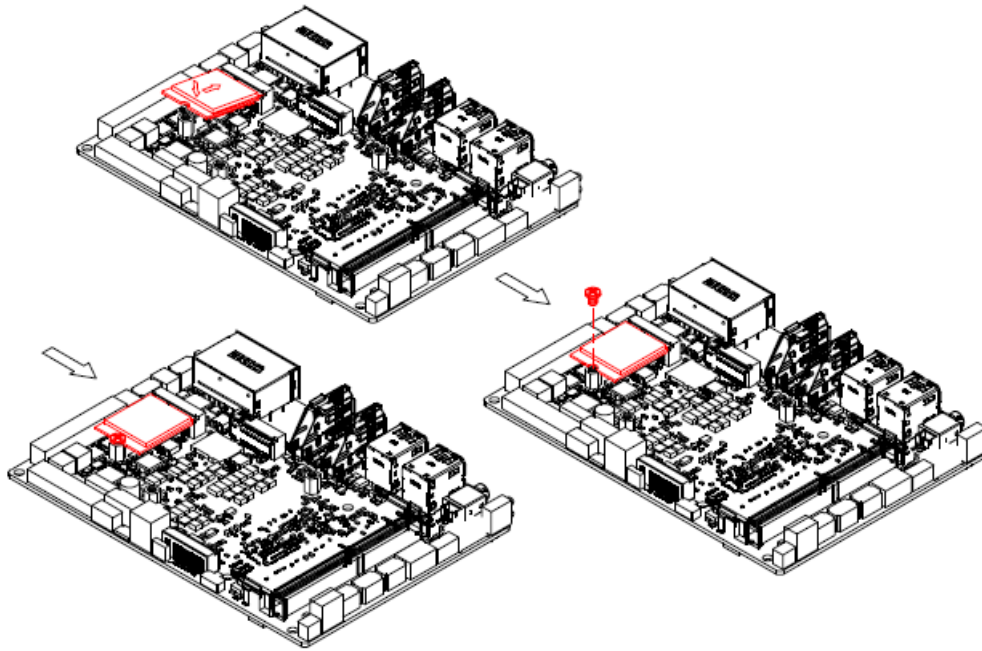

Step1. Insert M.2 E-Key card into designated locations and fasten with M3*4 screw to complete installation.

2.5 Installing M.2 M-Key (2242) card (EPC-TGU)

M-KEY(2242)

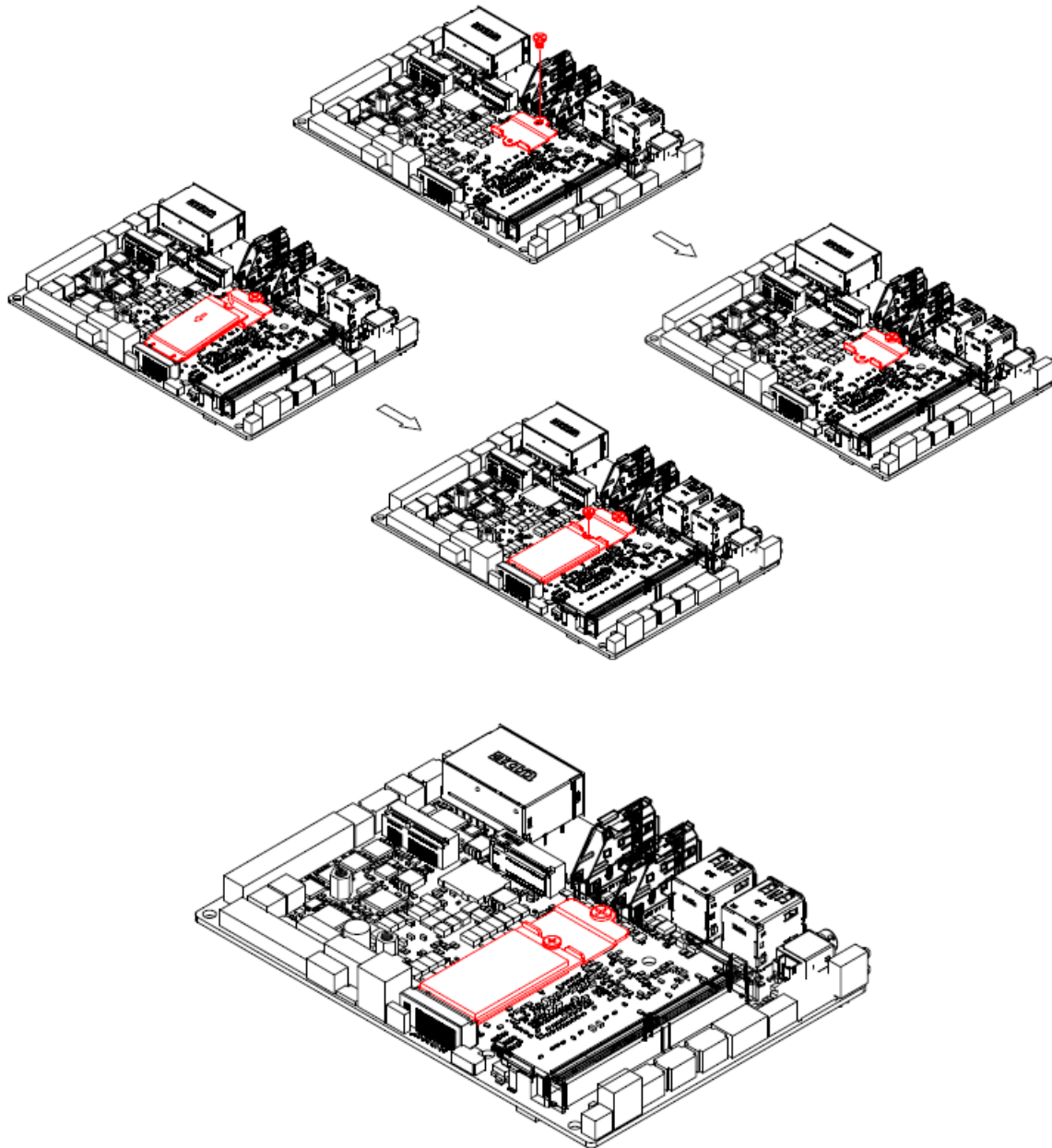

Step1. Fix bracket (24.6*22*3) and standoff screw with M3*4 screw.

Step2. Insert M.2 M-Key (2242) card into designated locations and connect the bracket (24.6*22*3) with M2*3 screws to complete installation.

2.6 Installing Mounting Brackets (EPC-TGU)

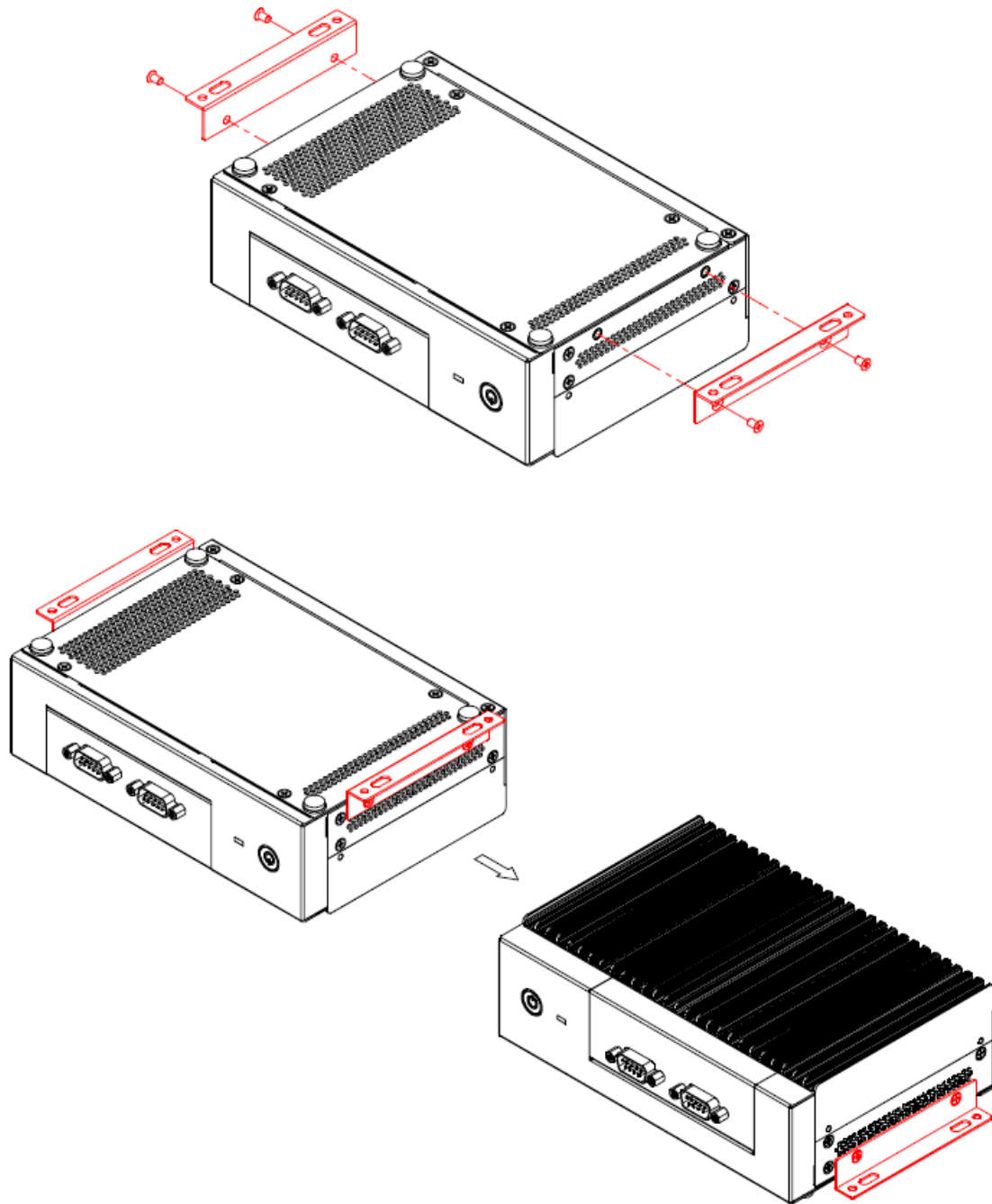

Step1. Fasten four M3*5 screws on each side of the system to secure Mounting brackets.

3. BIOS Setup

3.1 Introduction

The BIOS setup program allows users to modify the basic system configuration. In this following chapter will describe how to access the BIOS setup program and the configuration options that may be changed.

3.2 Starting Setup

AMI BIOS™ is immediately activated when you first power on the computer. The BIOS reads the system information contained in the NVRAM and begins the process of checking out the system and configuring it. When it finishes, the BIOS will seek an operating system on one of the disks and then launch and turn control over to the operating system.

While the BIOS is in control, the Setup program can be activated in one of two ways:

By pressing <ESC> or immediately after switching the system on, or

By pressing the <ESC> or key when the following message appears briefly at the left-top of the screen during the POST (Power On Self Test).

Press <ESC> or to enter SETUP

If the message disappears before you respond and you still wish to enter Setup, restart the system to try again by turning it OFF then ON or pressing the "RESET" button on the system case. You may also restart by simultaneously pressing <Ctrl>, <Alt>, and <Delete> keys.

3.3 Using Setup

In general, you use the arrow keys to highlight items, press <Enter> to select, use the PageUp and PageDown keys to change entries, press <F1> for help and press <Esc> to quit. The following table provides more detail about how to navigate in the Setup program using the keyboard.

Button	Description
↑	Move to previous item
↓	Move to next item
←	Move to the item in the left hand
→	Move to the item in the right hand
Esc key	Main Menu -- Quit and not save changes into NVRAM Status Page Setup Menu and Option Page Setup Menu -- Exit current page and return to Main Menu
+ key	Increase the numeric value or make changes
- key	Decrease the numeric value or make changes
F1 key	General help, only for Status Page Setup Menu and Option Page Setup Menu
F2 key	Previous Values
F3 key	Optimized defaults
F4 key	Save & Exit Setup

- **Navigating Through The Menu Bar**

Use the left and right arrow keys to choose the menu you want to be in.



Note: Some of the navigation keys differ from one screen to another.

- **To Display a Sub Menu**

Use the arrow keys to move the cursor to the sub menu you want. Then press <Enter>. A “➤” pointer marks all sub menus.

3.4 Getting Help

Press F1 to pop up a small help window that describes the appropriate keys to use and the possible selections for the highlighted item. To exit the Help Window press <Esc> or the <Enter> key again.

3.5 In Case of Problems

If, after making and saving system changes with Setup, you discover that your computer no longer is able to boot, the AMI BIOS supports an override to the NVRAM settings which resets your system to its defaults.

The best advice is to only alter settings which you thoroughly understand. To this end, we strongly recommend that you avoid making any changes to the chipset defaults. These defaults have been carefully chosen by both BIOS Vendor and your systems manufacturer to provide the absolute maximum performance and reliability. Even a seemingly small change to the chipset setup has the potential for causing you to use the override.

3.6 BIOS setup

Once you enter the Aptio Setup Utility, the Main Menu will appear on the screen. The Main Menu allows you to select from several setup functions and exit choices. Use the arrow keys to select among the items and press <Enter> to accept and enter the sub-menu.

3.6.1 Main Menu

This section allows you to record some basic hardware configurations in your computer and set the system clock.

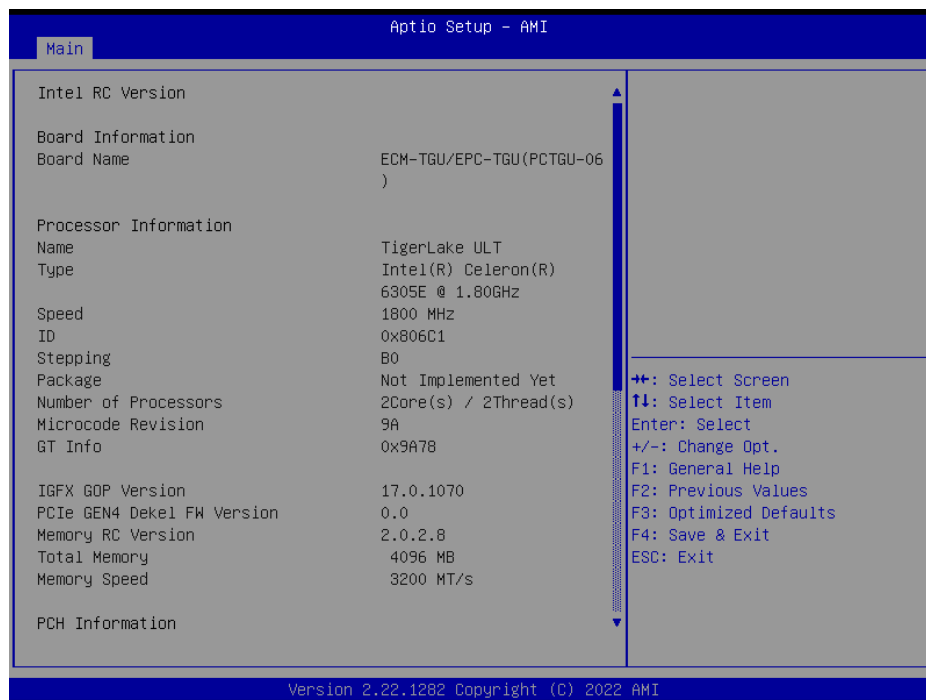
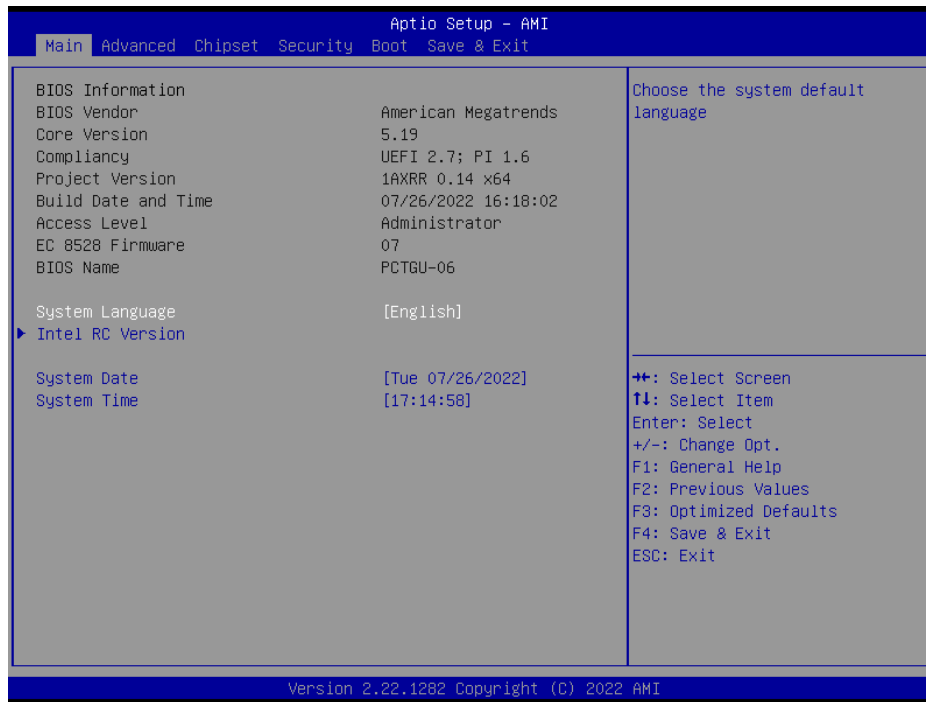

EPC-TGU

3.6.1.1 System Language

This option allows choosing the system default language.

3.6.1.2 System Date

Use the system date option to set the system date. Manually enter the day, month and year.

3.6.1.3 System Time

Use the system time option to set the system time. Manually enter the hours, minutes and seconds.



Note: The BIOS setup screens shown in this chapter are for reference purposes only, and may not exactly match what you see on your screen.

3.6.2 Advanced Menu

This section allows you to configure your CPU and other system devices for basic operation through the following sub-menus.

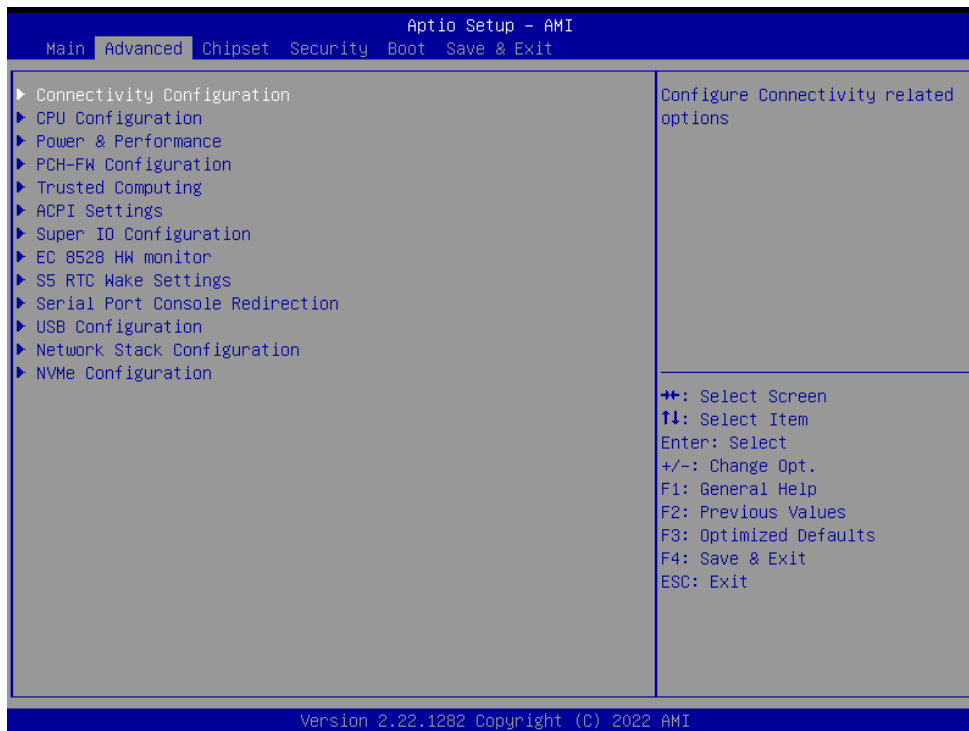

3.6.2.1 Connectivity Configuration

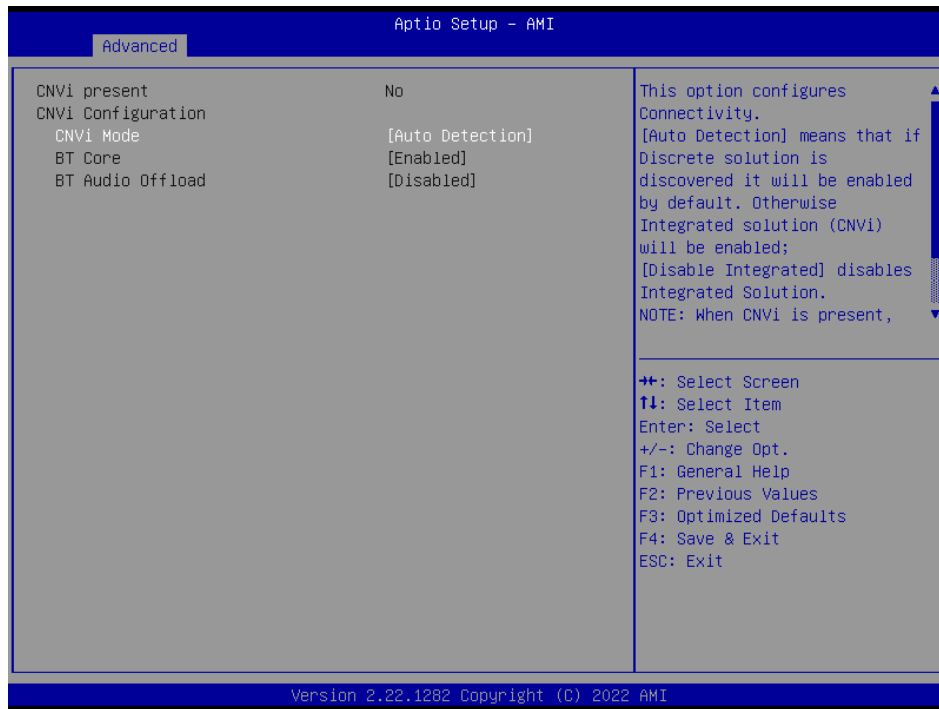

Item	Options	Description
CNVi Mode	Disable Integrated Auto Detection [Default]	This option configures Connectivity. [Auto Detection] means that if Discrete solution is discovered it will be enabled by default. Otherwise Integrated solution (CNVi) will be enabled; [Disable Integrated] disables Integrated Solution. NOTE: When CNVi is present, the GPIO pins that are used for radio.

3.6.2.2 CPU Configuration

Use the CPU configuration menu to view detailed CPU specification and configure the CPU.

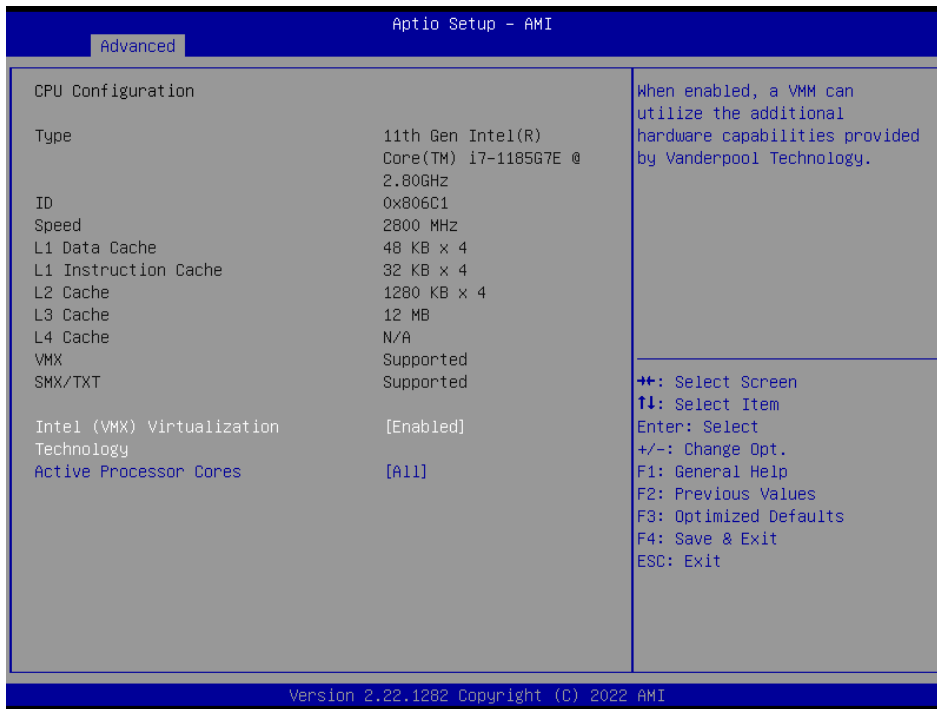

Item	Options	Description
Intel (VMX) Virtualization Technology	Disabled Enabled[Default]	When enabled, a VMM can utilize the additional hardware capabilities provided by Vanderpool Technology.
Active Processor Cores	All[Default] 1 2 3 4 5 6 7 8	Number of cores to enable in each processor package.

3.6.2.3 Power & Performance

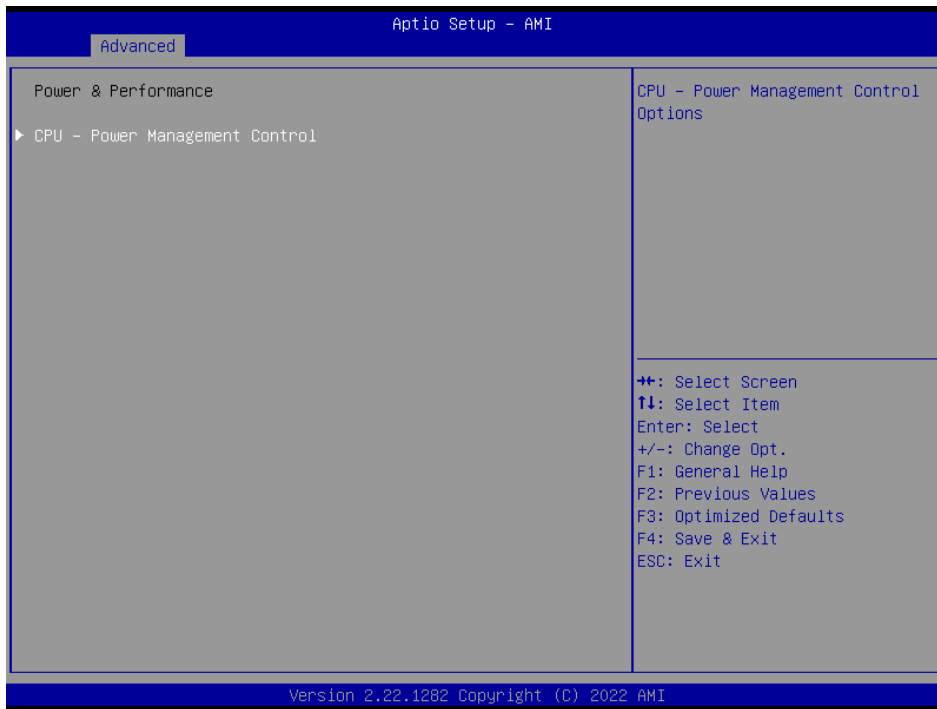

3.6.2.3.1 CPU – Power Management Control

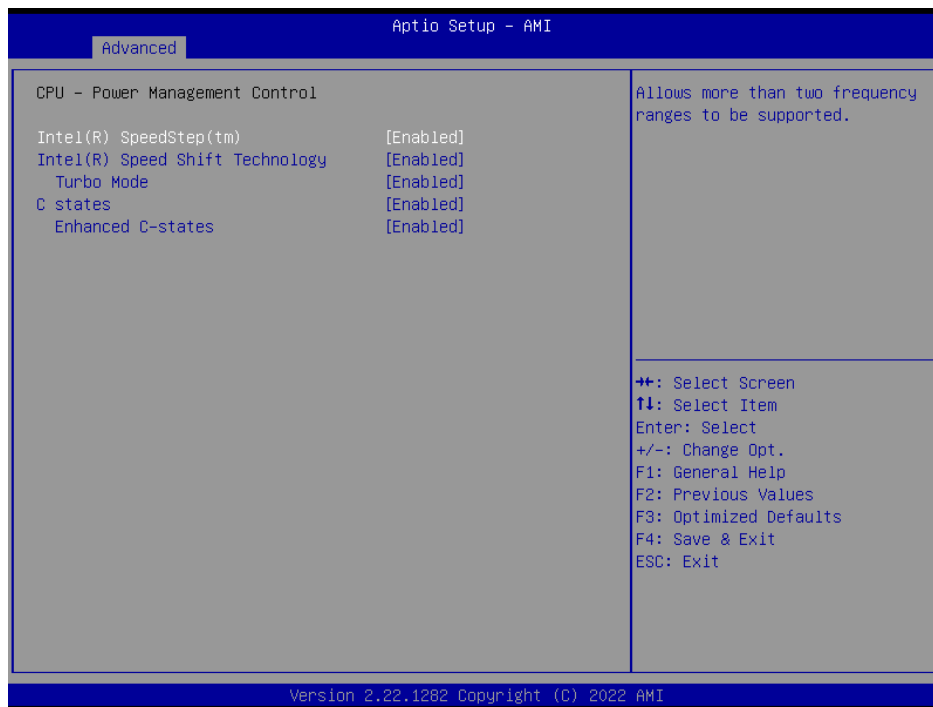

Item	Option	Description
Intel® SpeedStep™	Enabled[Default], Disabled	Allows more than two frequency ranges to be supported.
Intel® Speed Shift Technology	Enabled[Default], Disabled	Enable/Disable Intel® Speed Shift Technology support. Enabling will expose the CPPC v2 interface to allow for hardware controlled P-states.

EPC-TGU

Turbo Mode	Enabled[Default], Disabled	Enable/Disable processor Turbo Mode (requires Intel Speed Step or Intel Speed Shift to be available and enabled).
C States	Enabled[Default], Disabled	Enable/Disable CPU Power Management.
Enhanced C-States	Enabled[Default], Disabled	Enable/Disable C1E. When enabled, CPU will switch to minimum speed when all cores enter C-State.

3.6.2.4 PCH-FW Configuration

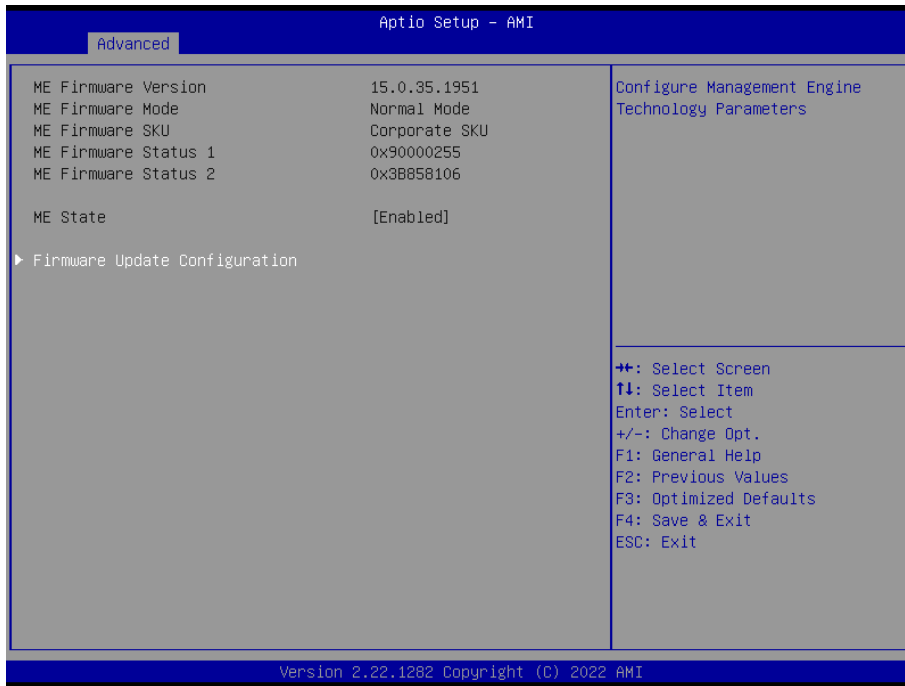

3.6.2.4.1 Firmware Update Configuration



Item	Option	Description
ME FW Image Re-Flash	Disabled[Default], Enabled	Enable/Disable Me FW Image Re-Flash function.

3.6.2.5 Trusted Computing

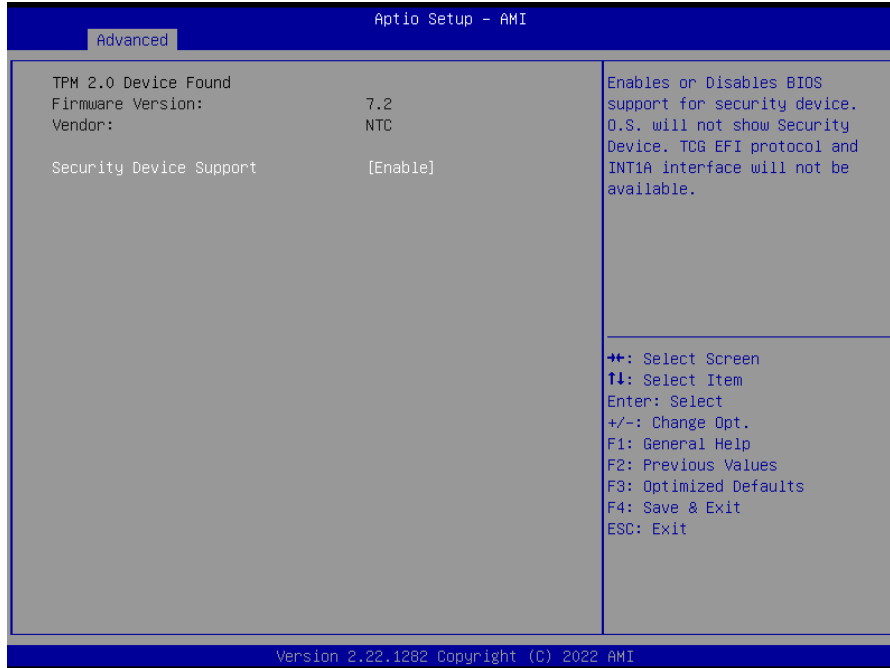

Item	Options	Description
Security Device Support	Disable, Enable[Default]	Enables or Disables BIOS support for security device. O.S. will not show Security Device. TCG EFI protocol and INT1A interface will not be available.

3.6.2.6 APCI Settings



EPC-TGU

Item	Options	Description
Enable Hibernation	Disabled Enabled[Default],	Enables or Disables System ability to Hibernate (OS/S4 Sleep State). This option may not be effective with some OS.
ACPI Sleep State	Suspend Disabled, S3 (Suspend to RAM)[Default]	Select the highest ACPI sleep state the system will enter when the SUSPEND button is pressed.

3.6.2.7 Super IO Configuration

You can use this item to set up or change the Super IO configuration for serial ports. Please refer to 3.6.2.7.1 ~ 3.6.2.7.2 for more information.



Item	Description
Serial Port 1 Configuration	Set Parameters of Serial Port 1 (COMA).
Serial Port 2 Configuration	Set Parameters of Serial Port 2 (COMB).

3.6.2.7.1 Serial Port 1 Configuration

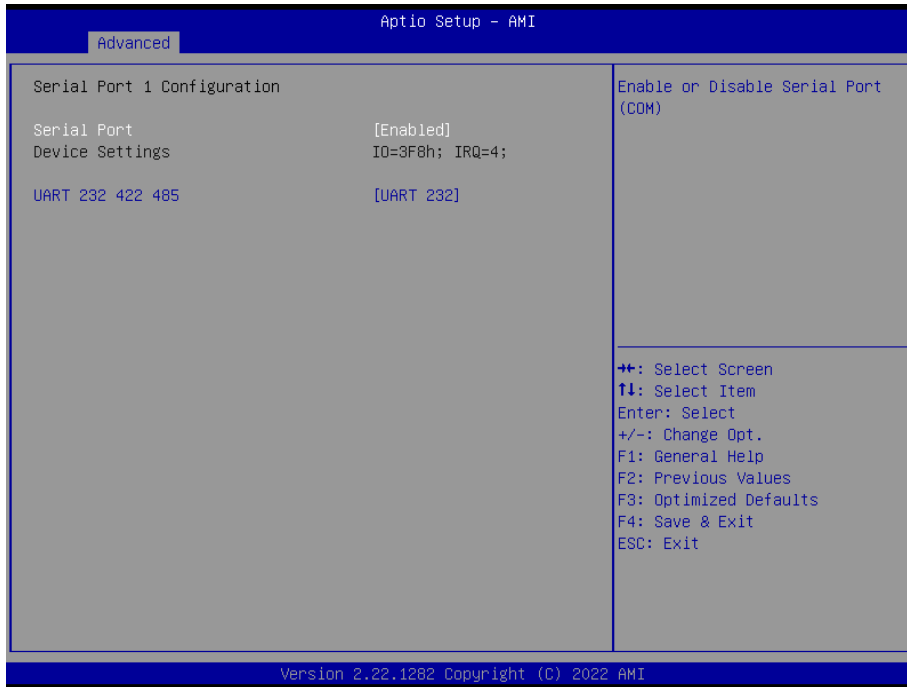

Item	Option	Description
Serial Port	Enabled[Default], Disabled	Enable or Disable Serial Port (COM).
UART 232 422 485	UART 232[Default] UART 422 UART 485	Change the Serial Port as RS232/422/485.

3.6.2.7.2 Serial Port 2 Configuration

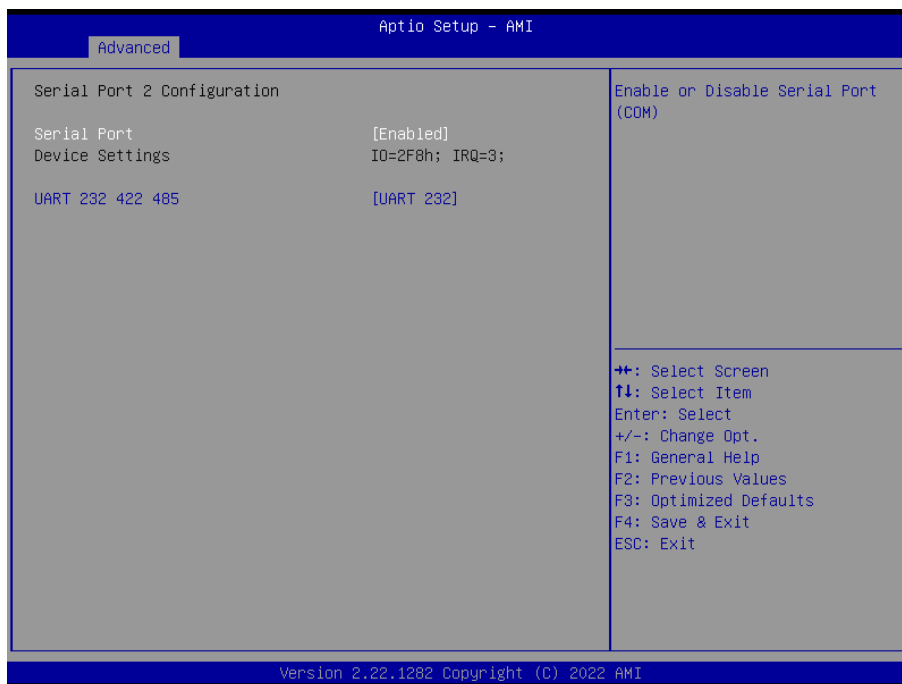

Item	Option	Description
Serial Port	Enabled[Default],	Enable or Disable Serial Port (COM).

EPC-TGU

	Disabled	
UART 232 422 485	UART 232[Default] UART 422 UART 485	Change the Serial Port as RS232/422/485.

3.6.2.8 HW Monitor

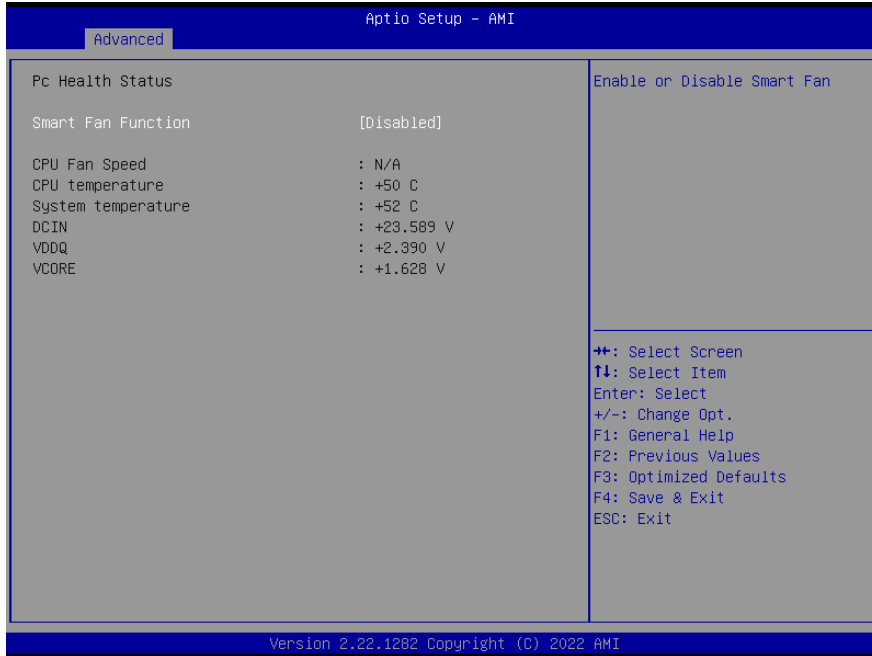

Item	Options	Description
Smart Fan Function	Enabled, Disabled [Default]	Enables or Disables Smart Fan.

3.6.2.9 S5 RTC Wake Settings



Item	Options	Description
Wake system from S5	Disabled[Default], Fixed Time Dynamic Time	Enable or disable System wake on alarm event. Select Fixed Time, system will wake on the hr::min::sec specified. Select Dynamic Time, System will wake on the current time + Increase minute(s).

3.6.2.10 Serial Port Console Redirection

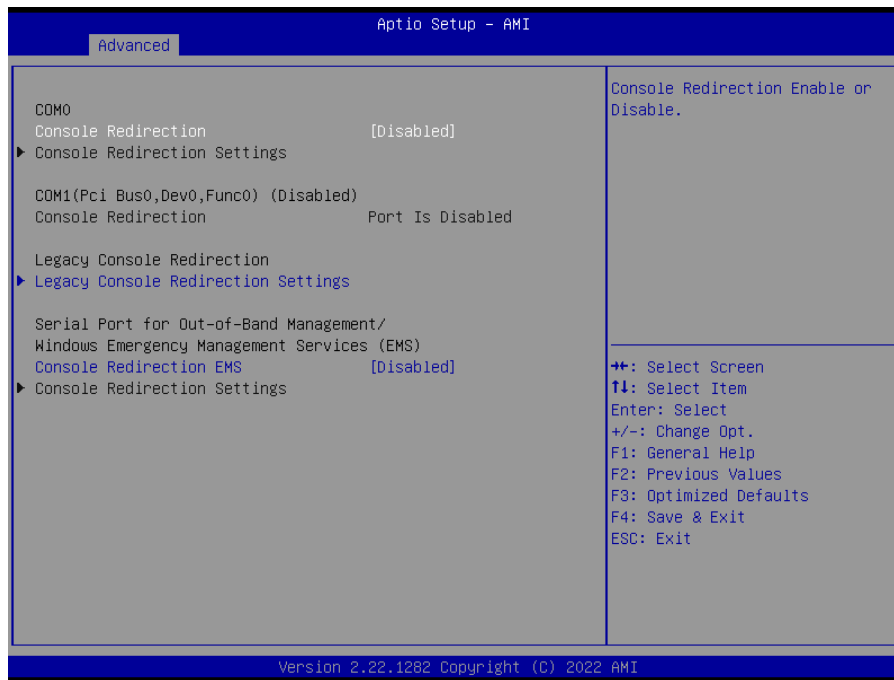

Item	Options	Description
Console Redirection	Disabled[Default], Enabled	Console Redirection Enable or Disable.
Console Redirection EMS	Disabled[Default], Enabled	Console Redirection Enable or Disable.

3.6.2.10.1 Legacy Console Redirection Settings



Item	Option	Description
Redirection COM Port	COM0[Default]	Select a COM port to display redirection of Legacy OS and Legacy OPRM Messages.

3.6.2.11 USB Configuration

The USB Configuration menu helps read USB information and configures USB settings.

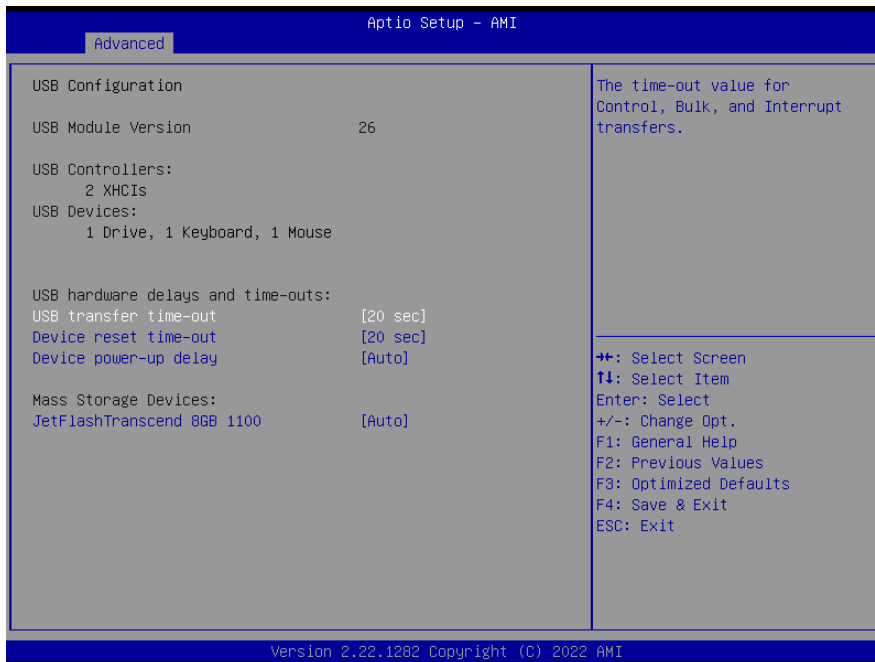

Item	Options	Description
USB transfer time-out	1 sec 5 sec 10 sec 20 sec[Default]	The time-out value for Control, Bulk, and Interrupt transfers.

Device reset time-out	10 sec 20 sec [Default] 30 sec 40 sec	USB mass storage device Start Unit command time-out.
Device power-up delay	Auto [Default] Manual	Maximum time the device will take before it properly reports itself to the Host Controller. 'Auto' uses default value: for a Root port it is 100ms, for a Hub port the delay is taken form Hub descriptor.
Mass Storage Devices	Auto [Default] Floppy Forced FDD Hard Disk CD-ROM	Mass storage device emulation type. 'AUTO' enumerates devices according to their media format. Optical drives are emulated as 'CDROM', drives with no media will be emulated according to a drive type.

3.6.2.12 Network Stack Configuration



Item	Options	Description
Network Stack	Enabled Disabled [Default]	Enable/Disable UEFI Network Stack.

3.6.2.13 NVMe Configuration



Note:

RAID/RST Mode support RAID 0 & RAID 1.

To set RAID configuration, please follow the instruction below.

➤ Set RAID 0 (DATA Striping)

Step 1: Enter “VMD Configuration”

- Enable “Enable VMD controller”
- Enable “Map this Root Port under VMD”
- Select “Save Changes and Reset” to reboot system

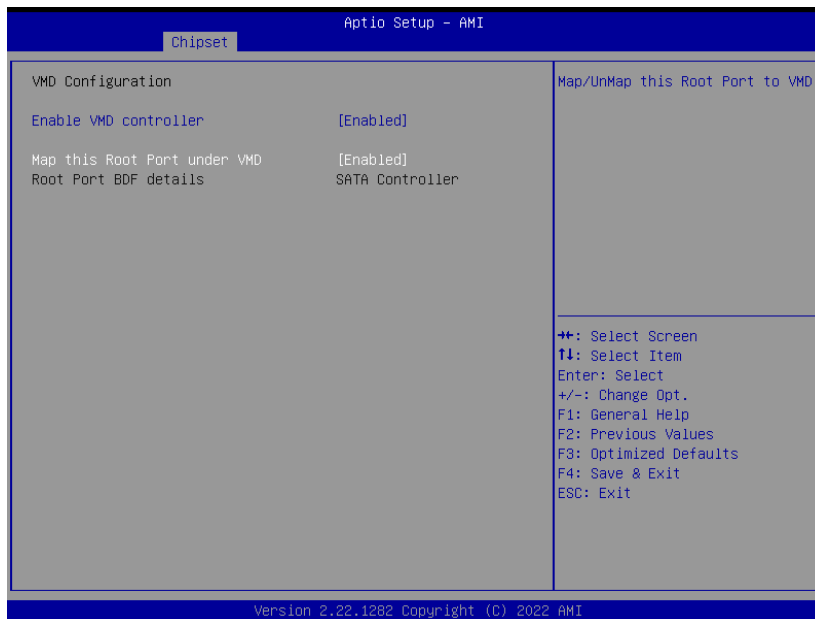

Step 2: After enabled “Enable VMD controller”, will show submenu “Intel(R) Rapid Storage Technology”, please enter it for RAID configuration.

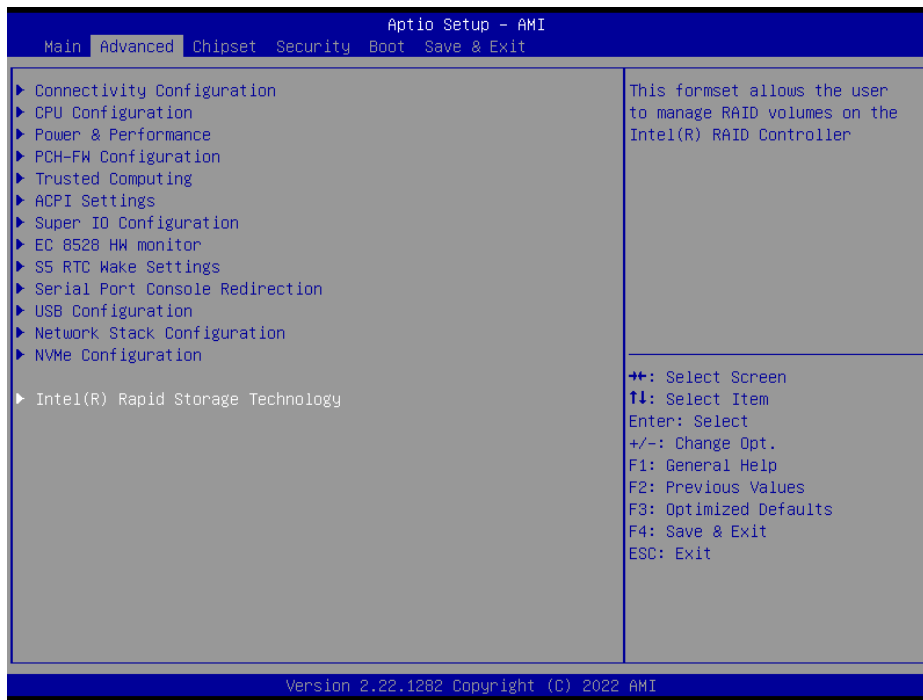

Step 3: Enter “Create RAID Volume”



Step 4:

- Enter “Name” for the name of raid
- Set “RAID Level” as “RAID0 (Stripe)”

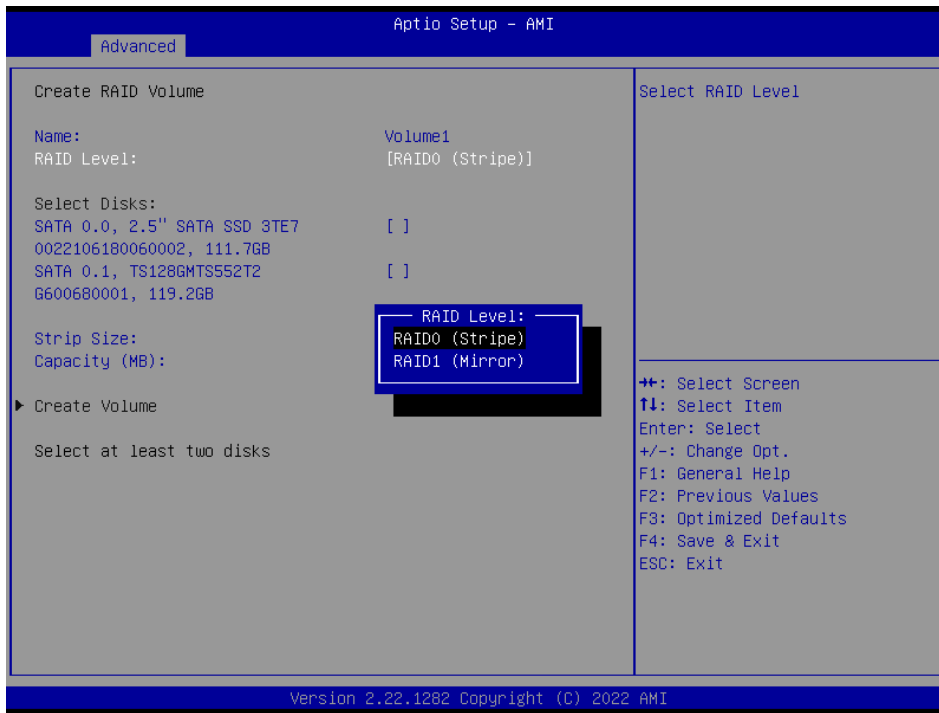

Step 5:

- Select disk SATA 0.0 and SATA 0.1
- Enter "Create Volume"

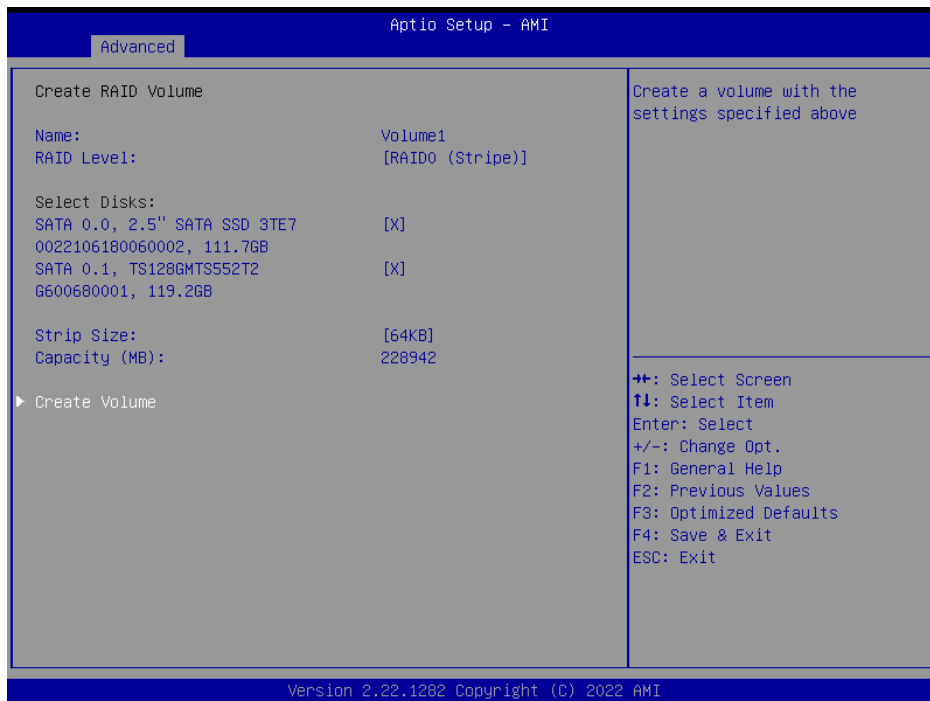

Step 6: Completed. This page shows the information of raid created by user

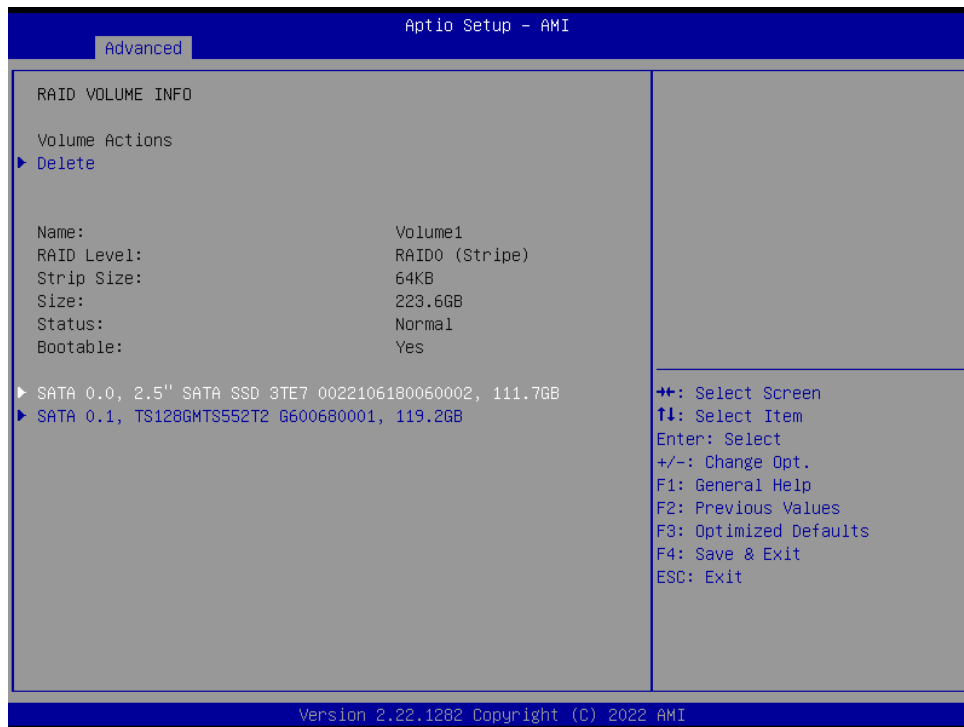

➤ **Delete Raid 0:**

Step 1: Enter "Delete"

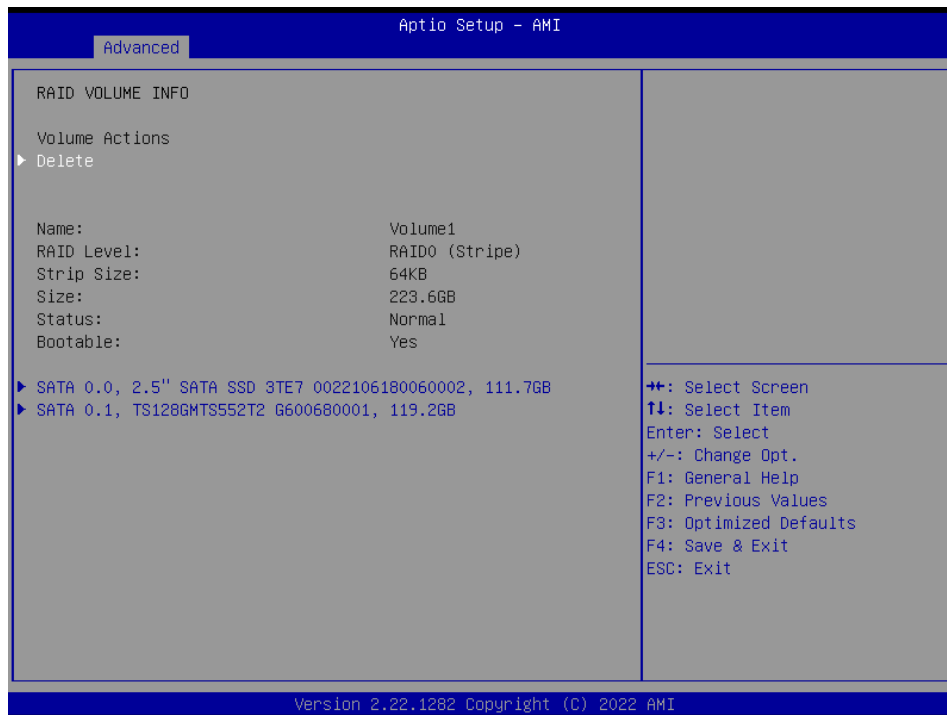

Step 2: Select "Yes" to delete RAID

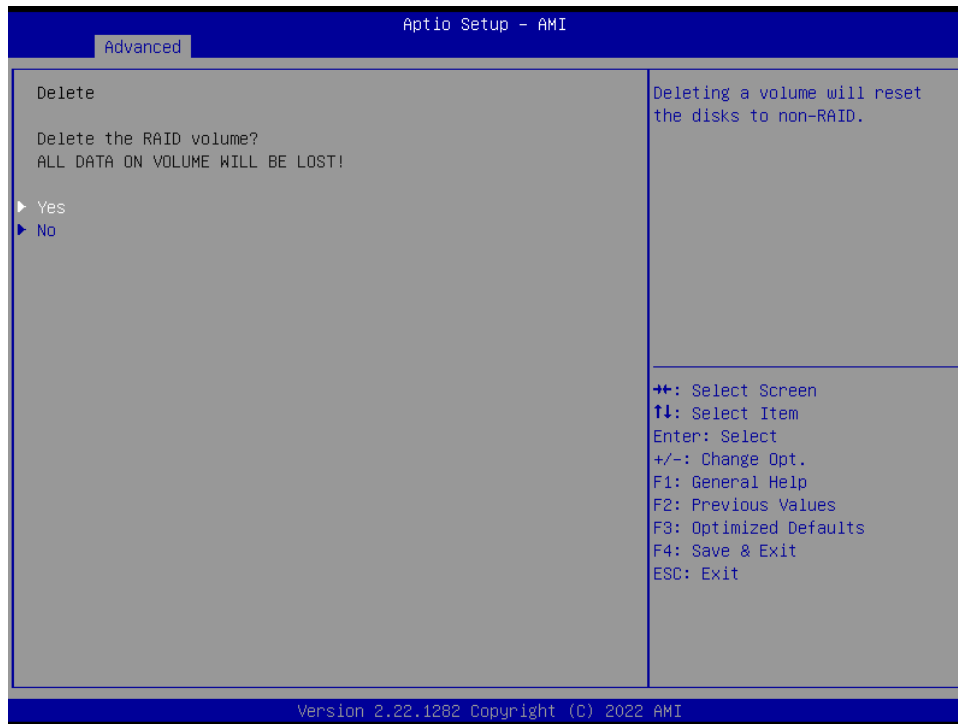

➤ Set RAID 1 (DATA Mirroring)

Step1: Enter “Create RAID Volume”

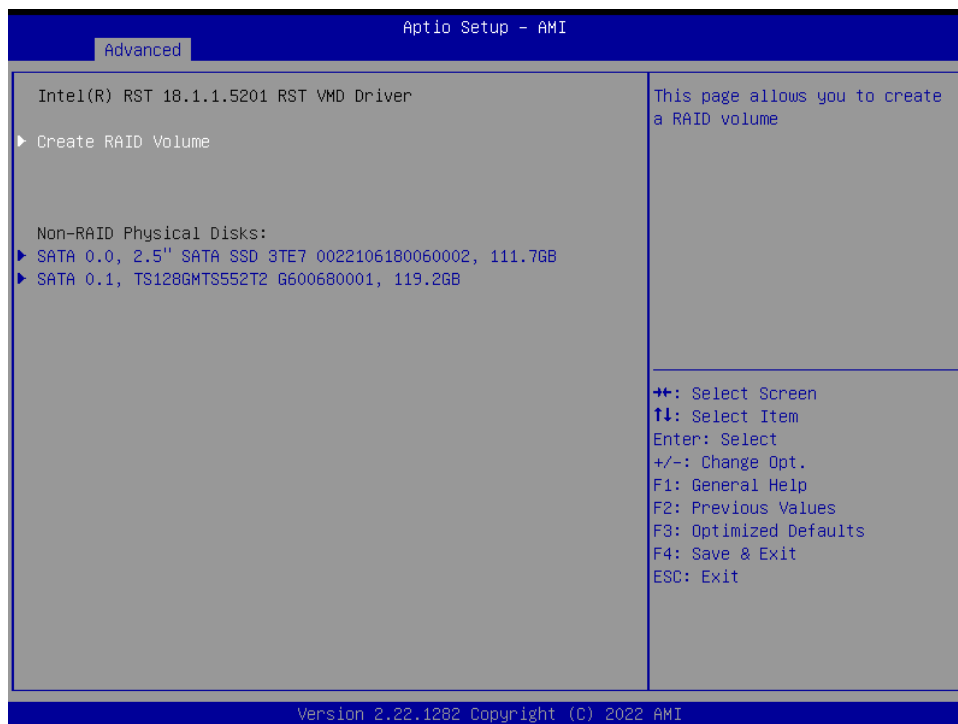

Step2:

- Enter “Name” for the name of raid
- Set “RAID Level “ as “RAID1 (Mirror)”
- Select disk “SATA 0.0” and ”SATA 0.1”
- Enter “Create Volume”

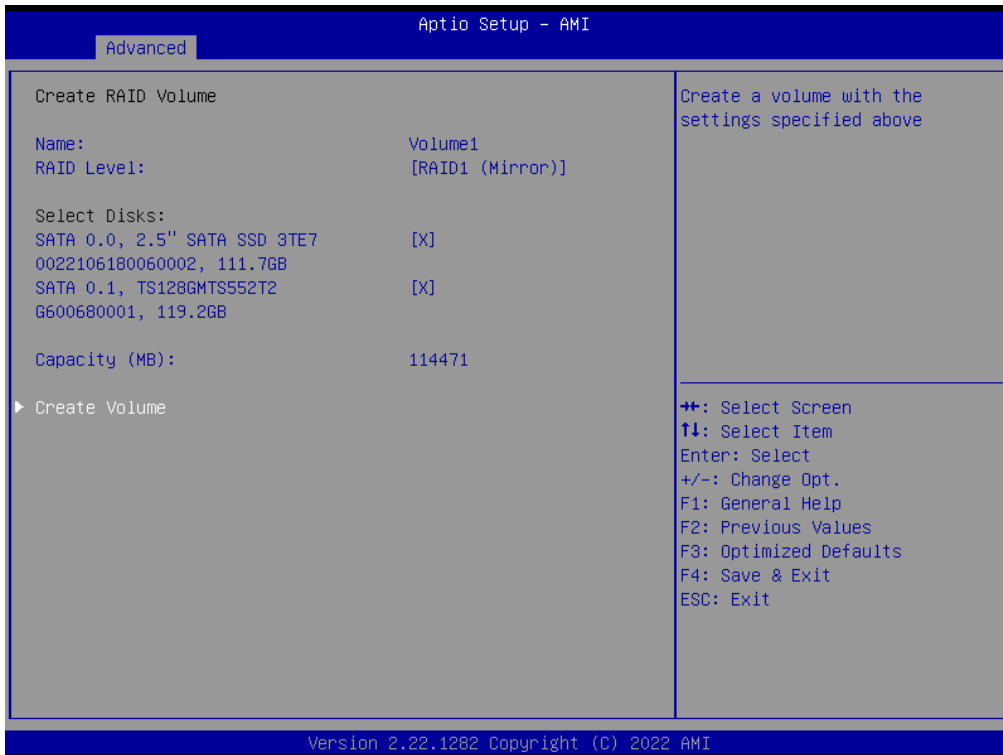

Step 3: Raid 1 be created. Select "Volume1" to see detail.

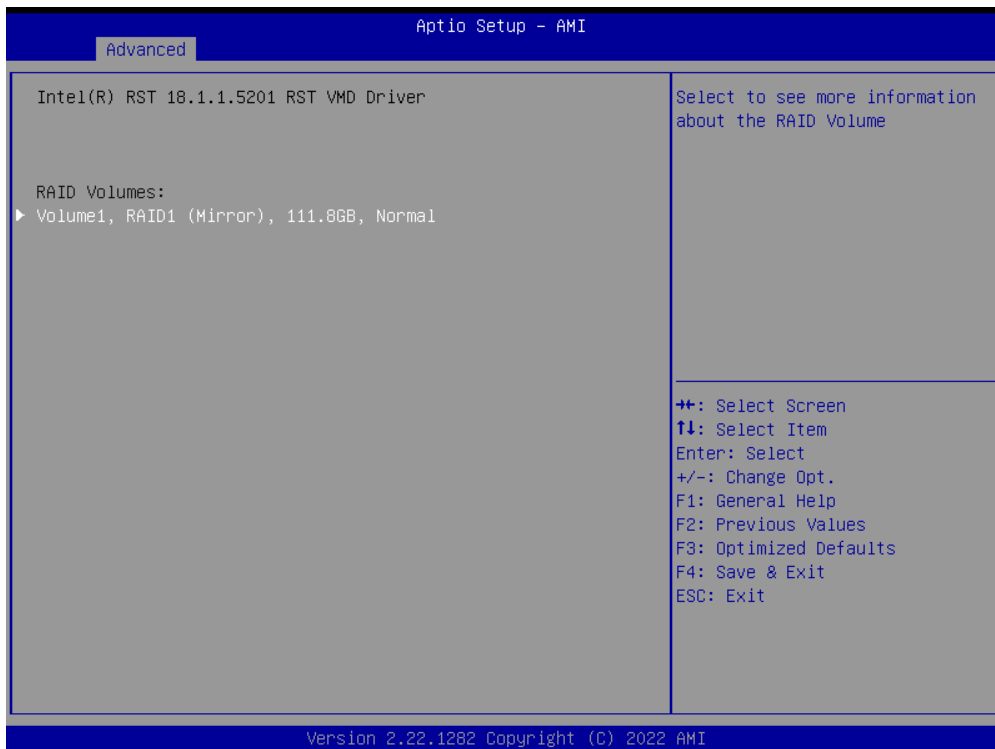

Step 4: Completed. This page show the information of raid created by user.

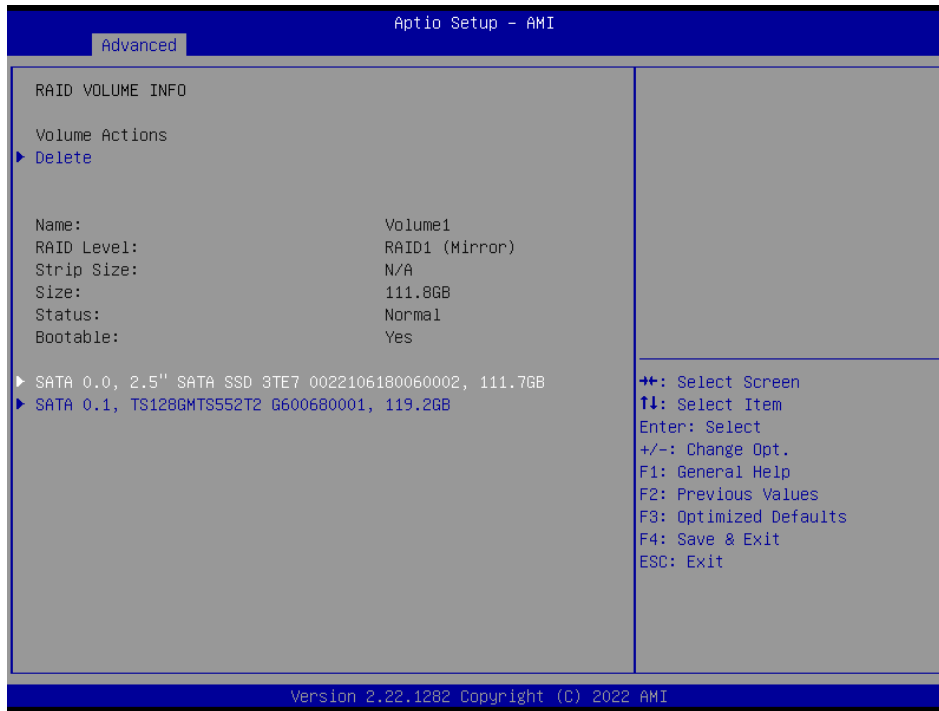

➤ Delete Raid 1

Step1: Enter “Delete”

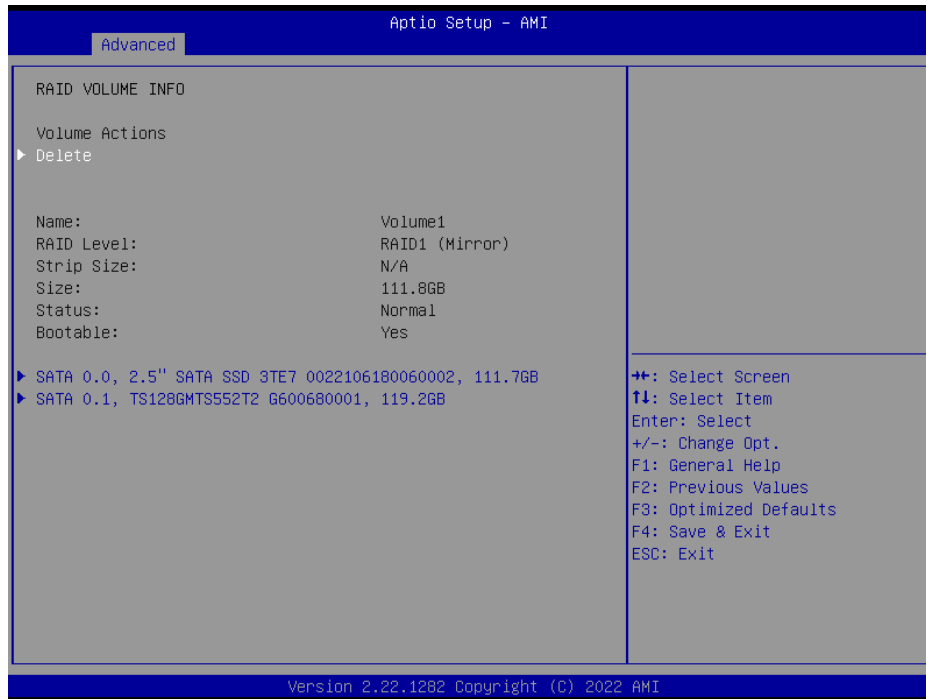

Step2: Select “Yes” to delete RAID

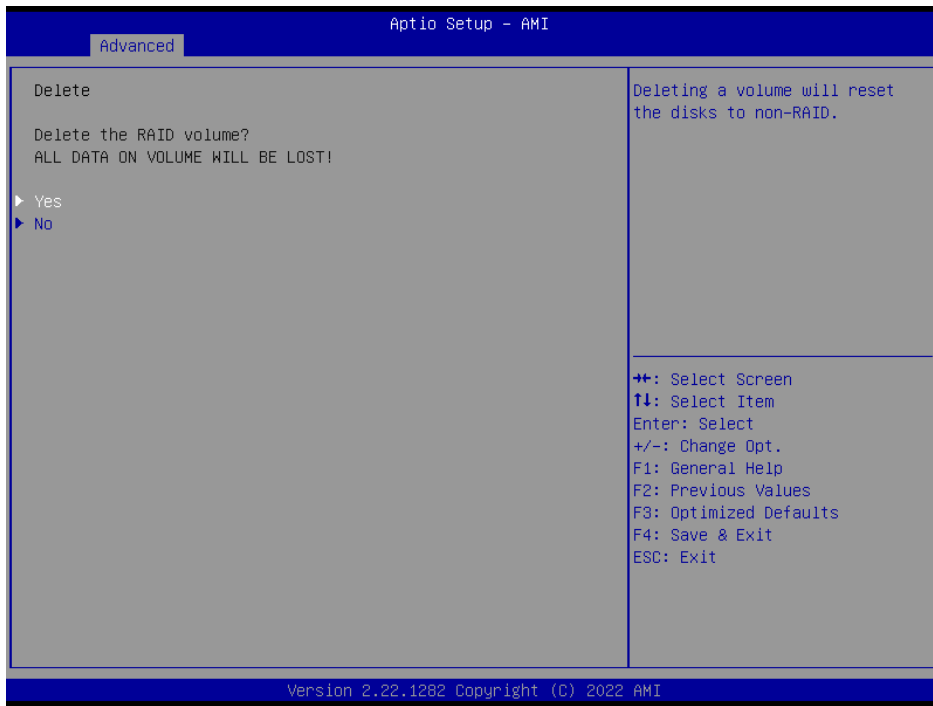

3.6.3 Chipset

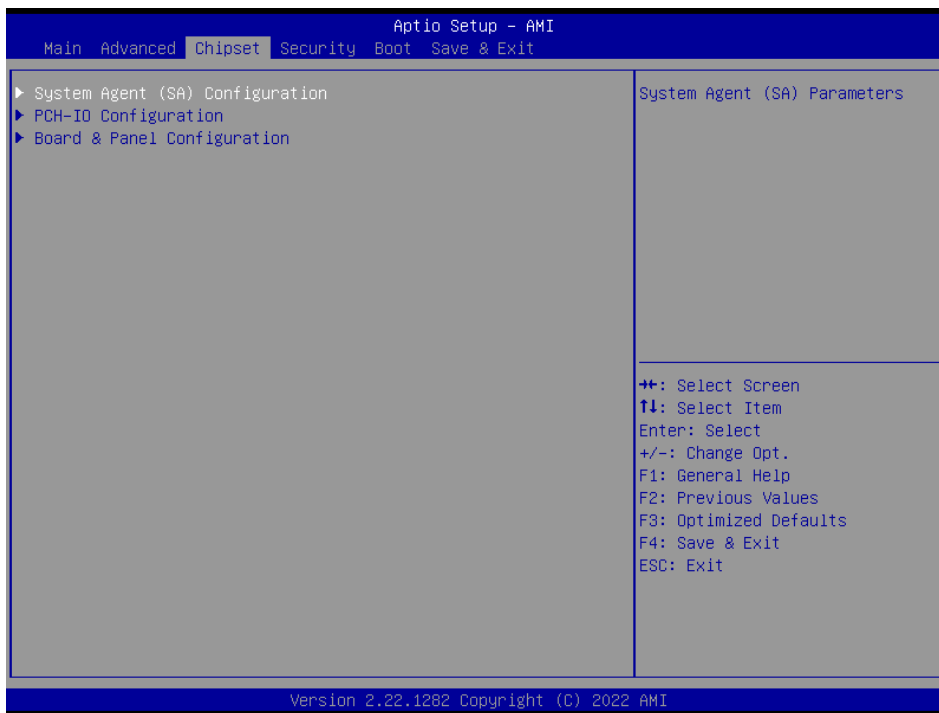

3.6.3.1 System Agent (SA) Configuration

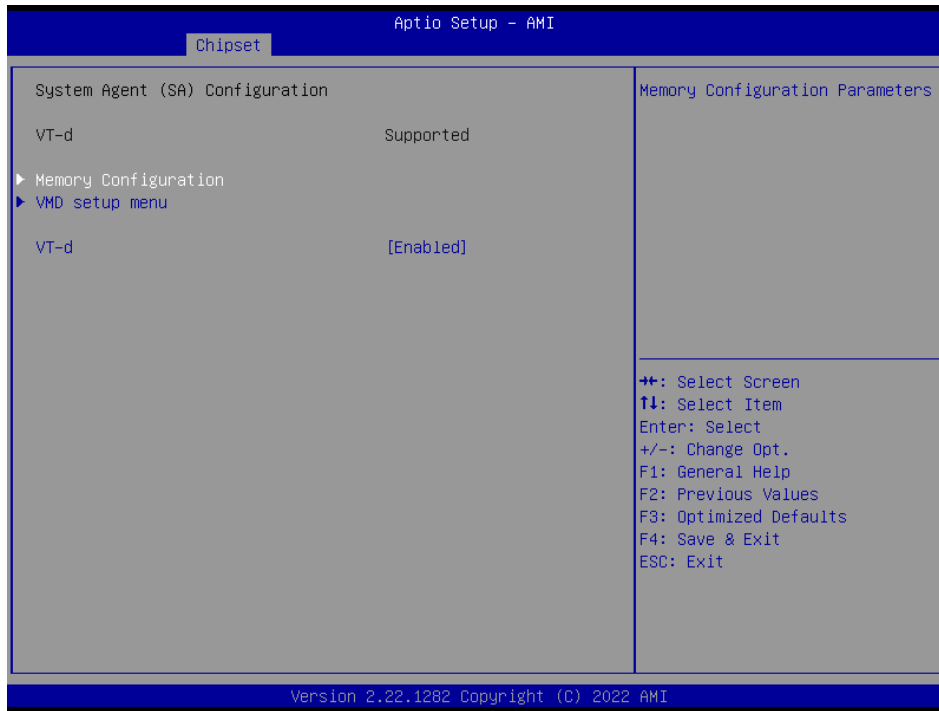

Item	Option	Description
VT-d	Enabled[Default] Disabled	VT-d capability.

3.6.3.1.1 Memory Configuration

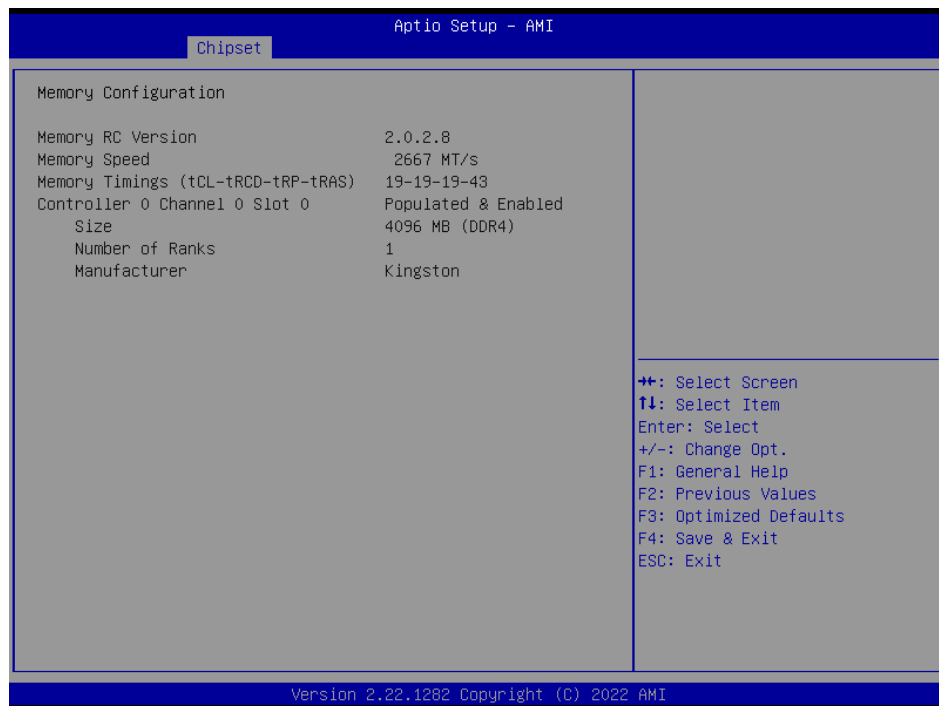

3.6.3.1.2 VMD setup menu

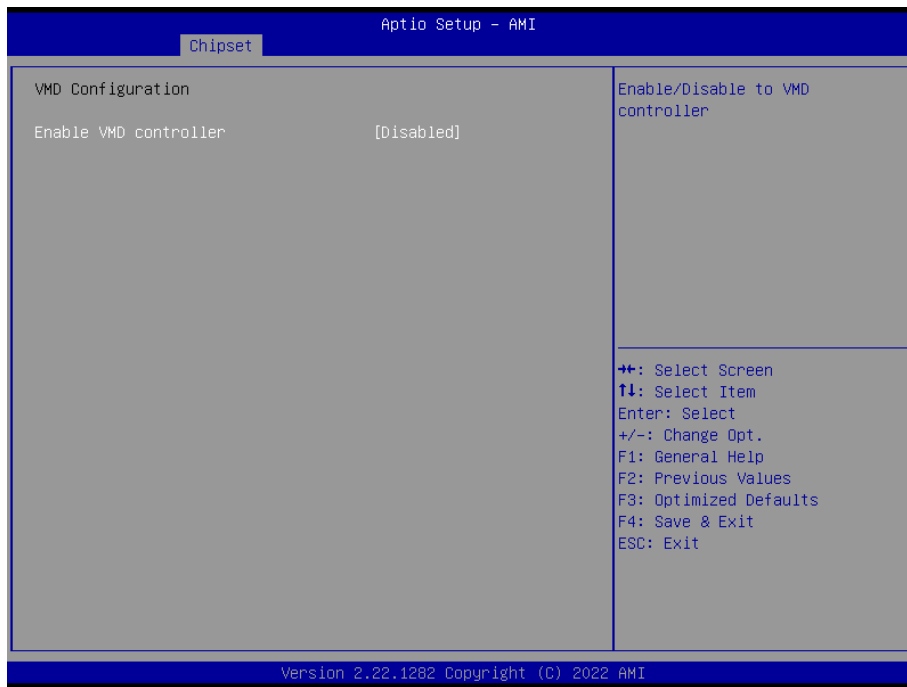

Item	Option	Description
Enable VMD controller	Enabled Disabled[Default]	Enable/Disable VMD controller.

3.6.3.2 PCH-IO Configuration



3.6.3.2.1 PCI Express Configuration

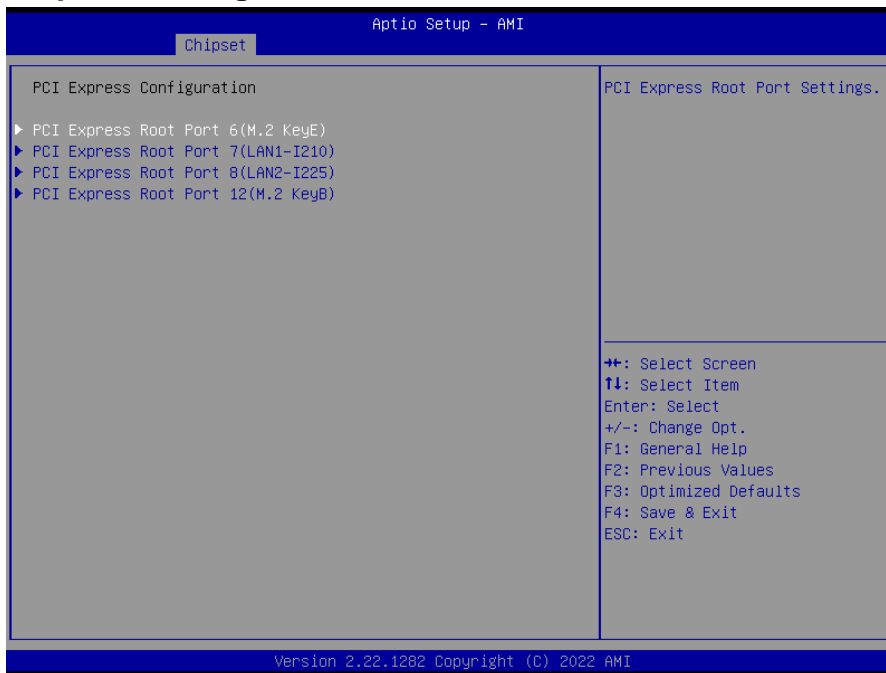

3.6.3.2.1.1 PCI Express Root Port 6(M.2 KeyE)

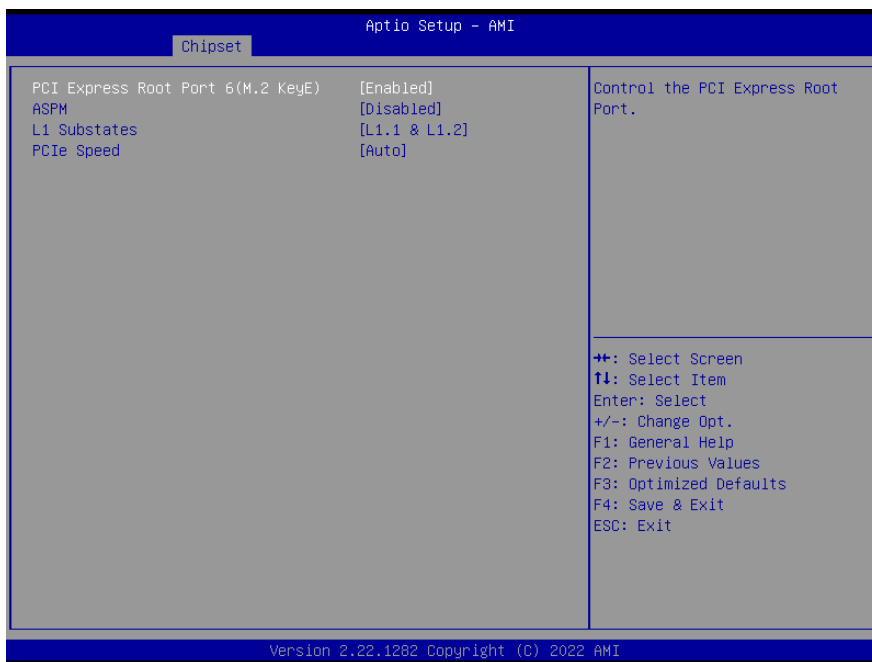

Item	Option	Description
PCI Express Root Port 6(M.2 KeyE)	Enabled[Default], Disabled	Control the PCI Express Root Port.
ASPM	Disabled[Default], L0s L1 L0sL1 Auto	Set the ASPM Level: Force L0s – Force all links to L0s State AUTO – BIOS auto configure DISABLE – Disables ASPM.

L1 Substates	Disabled, L1.1 L1.1 & L1.2[Default]	PCI Express L1 Substates settings.
PCIe Speed	Auto[Default] Gen1 Gen2 Gen3	Configure PCIe Speed.

3.6.3.2.1.2 PCI Express Root Port 7(LAN2-I210)

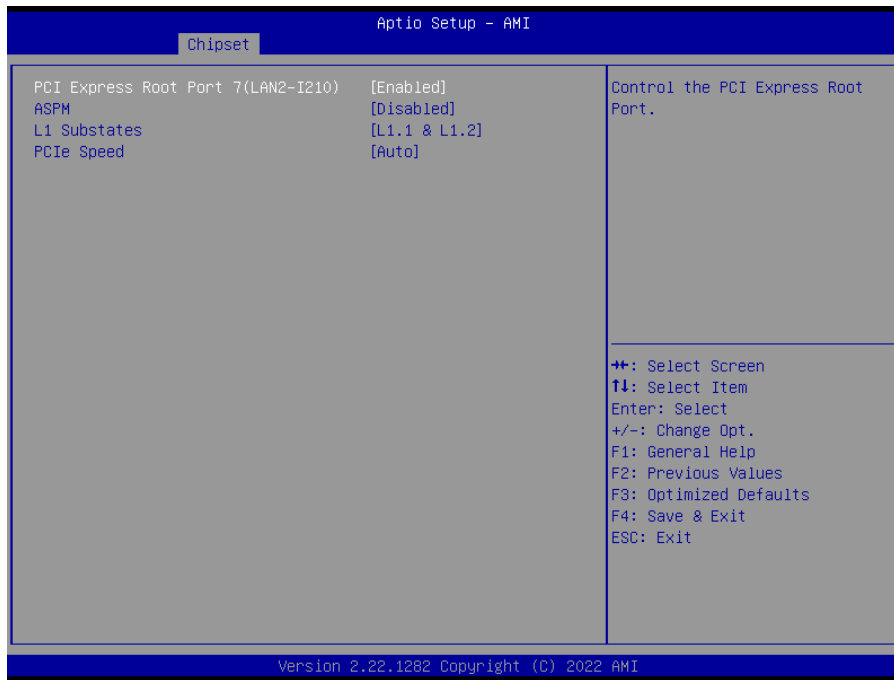

Item	Option	Description
PCI Express Root Port 7(LAN2-I210)	Enabled[Default], Disabled	Control the PCI Express Root Port.
ASPM	Disabled[Default], L0s L1 L0sL1 Auto	Set the ASPM Level: Force L0s – Force all links to L0s State AUTO – BIOS auto configure DISABLE – Disables ASPM.
L1 Substates	Disabled, L1.1 L1.1 & L1.2[Default]	PCI Express L1 Substates settings.
PCIe Speed	Auto[Default] Gen1 Gen2 Gen3	Configure PCIe Speed.

3.6.3.2.1.3 PCI Express Root Port 8(LAN3-I225)

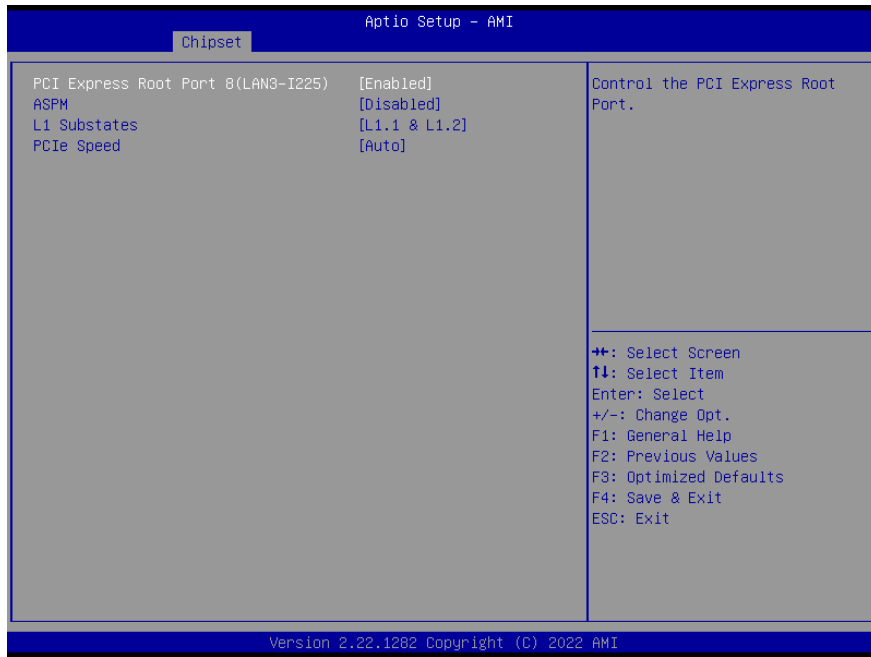

Item	Option	Description
PCI Express Root Port 8(LAN3-I225)	Enabled[Default], Disabled	Control the PCI Express Root Port.
ASPM	Disabled[Default], L0s L1 L0sL1 Auto	Set the ASPM Level: Force L0s – Force all links to L0s State AUTO – BIOS auto configure DISABLE – Disables ASPM.
L1 Substates	Disabled, L1.1 L1.1 & L1.2[Default]	PCI Express L1 Substates settings.
PCIe Speed	Auto[Default] Gen1 Gen2 Gen3	Configure PCIe Speed.

3.6.3.2.1.4 PCI Express Root Port 12(M.2 KeyB)

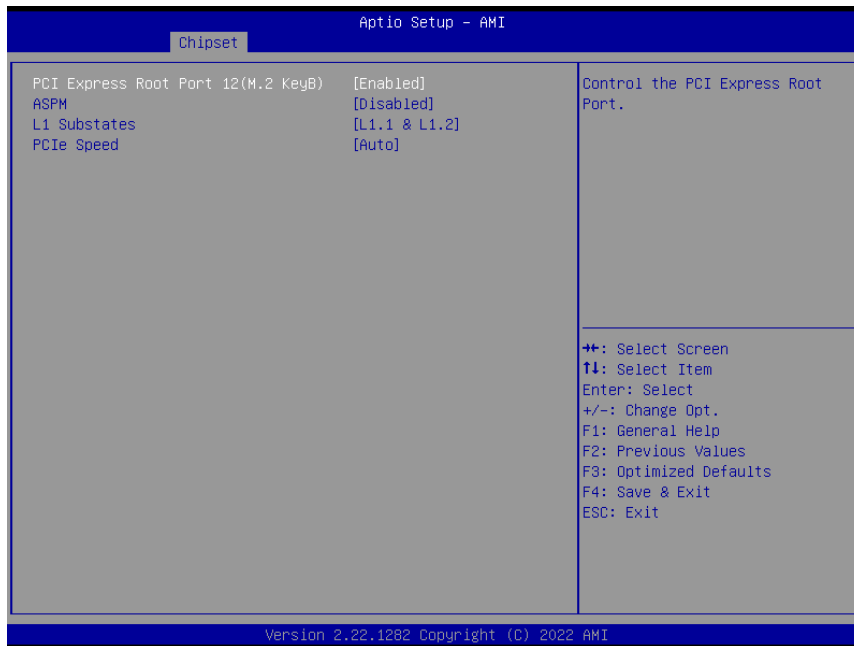

Item	Option	Description
PCI Express Root Port 12(M.2 KeyB)	Enabled[Default], Disabled	Control the PCI Express Root Port.
ASPM	Disabled[Default], L0s L1 L0sL1 Auto	Set the ASPM Level: Force L0s – Force all links to L0s State AUTO – BIOS auto configure DISABLE – Disables ASPM.
L1 Substates	Disabled, L1.1 L1.1 & L1.2[Default]	PCI Express L1 Substates settings.
PCIe Speed	Auto[Default] Gen1 Gen2 Gen3	Configure PCIe Speed.

3.6.3.2.2 SATA And RST Configuration



Item	Options	Description
SATA Controller(s)	Enabled[Default] Disabled,	Enable/Disable SATA Device.
Port 0	Enabled[Default] Disabled	Enable or Disable SATA Port.
Port 1	Enabled[Default] Disabled	Enable or Disable SATA Port.

3.6.3.2.3 HD Audio Configuration

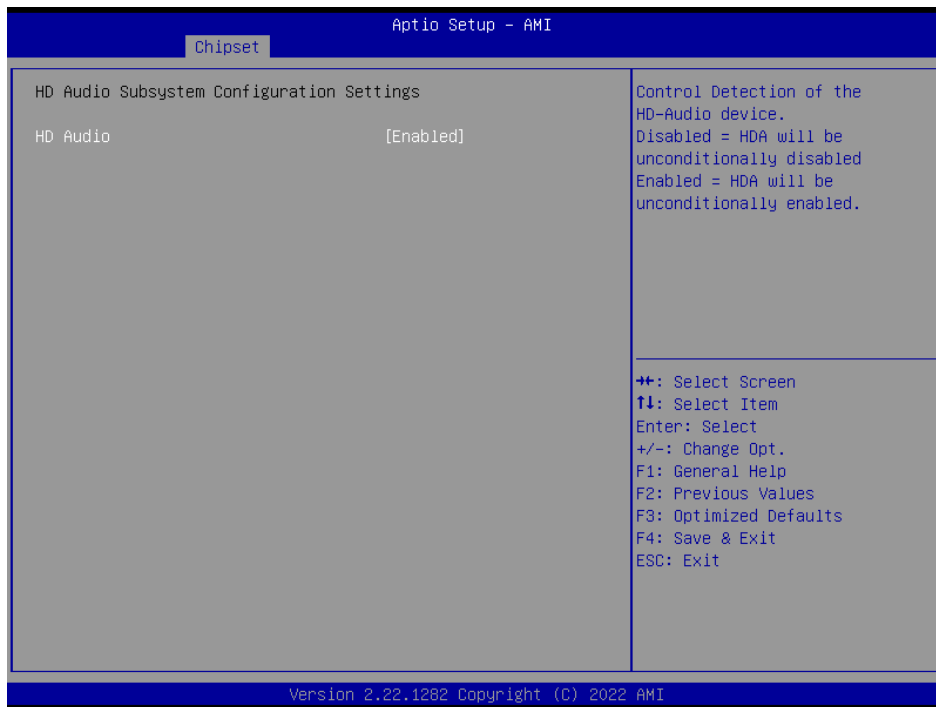

Item	Option	Description
HD Audio	Disabled Enabled[Default]	Control Detection of the HD-Audio device. Disable = HDA will be unconditionally disabled Enabled = HDA will be unconditionally enabled.

3.6.3.3 Board & Panel Configuration

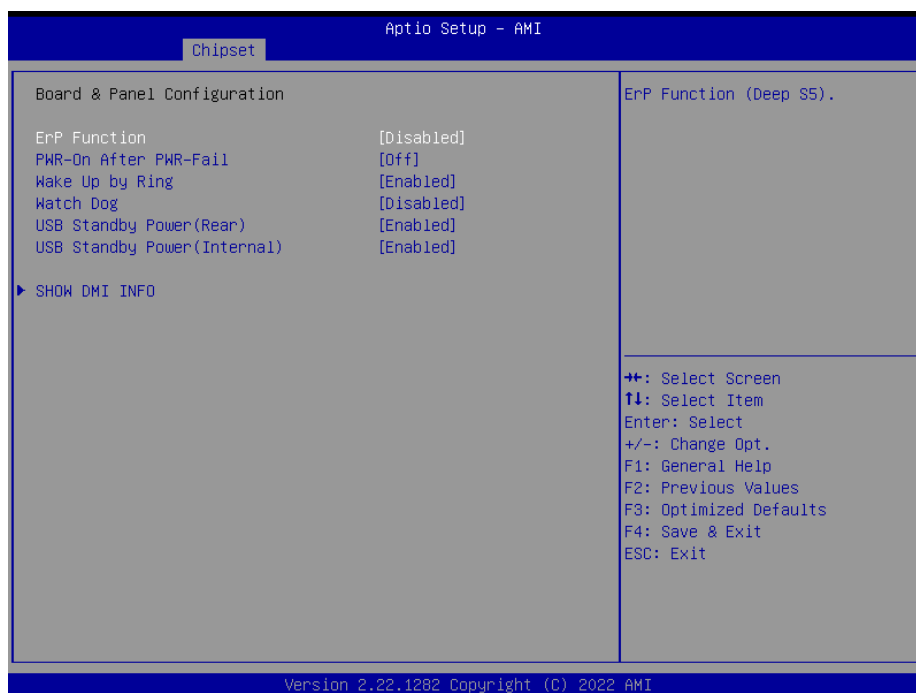

EPC-TGU

Item	Option	Description
ErP Function	Disabled[Default] Enabled	ErP Function (Deep S5).
PWR-On After PWR-Fail	Off[Default] On Last state	AC loss resume.
Wake Up by Ring	Disabled Enabled[Default]	Wake Up by Ring from S3/S4/S5.
Watch Dog	Disabled[Default] 30 sec 40 sec 50 sec 1 min 2 min 10 min 30 min	Select WatchDog.
USB Standby Power(Rear)	Disabled Enabled[Default]	Enable/Disabled USB Standby Power during S3/S4/S5.
USB Standby Power(Internal)	Disabled Enabled[Default]	Enable/Disabled USB Standby Power during S3/S4/S5.

3.6.3.3.1 SHOW DMI INFO

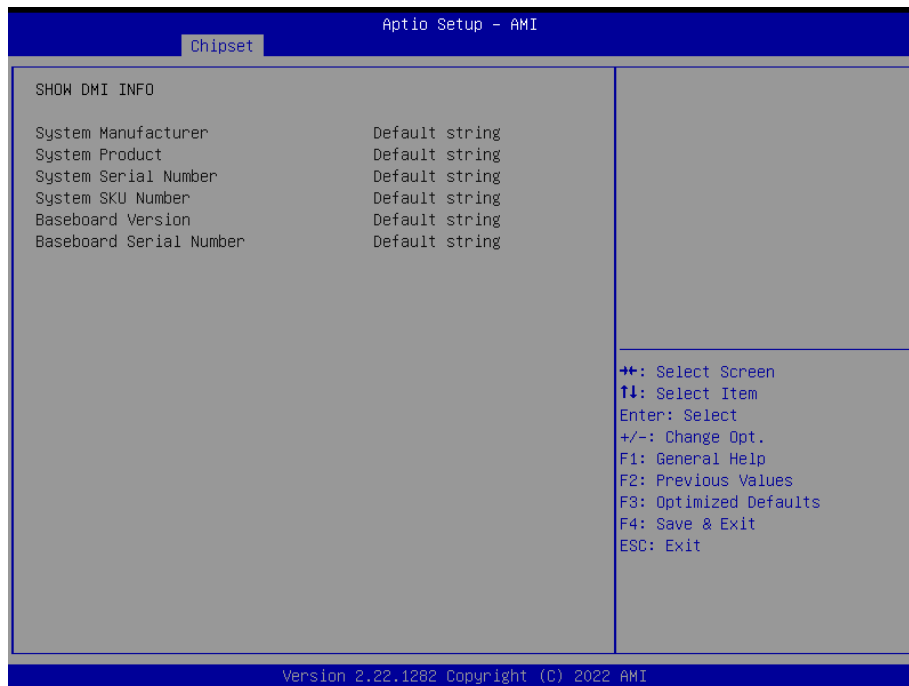

3.6.4 Security



- **Administrator Password**

Set setup Administrator Password

- **User Password**

Set User Password

3.6.4.1 Secure Boot



Item	Option	Description
Secure Boot	Disabled[Default] Enabled	Secure Boot feature is Active if Secure Boot is Enable, Platform Key(PK) is enrolled and the System is in User mode. The mode change requires platform reset.
Secure Boot Mode	Standard Custom[Default]	Secure Boot mode selector: Standard/Custom. In Custom mode Secure Boot Variables can be configured without authentication.

3.6.4.1.1 Key Management

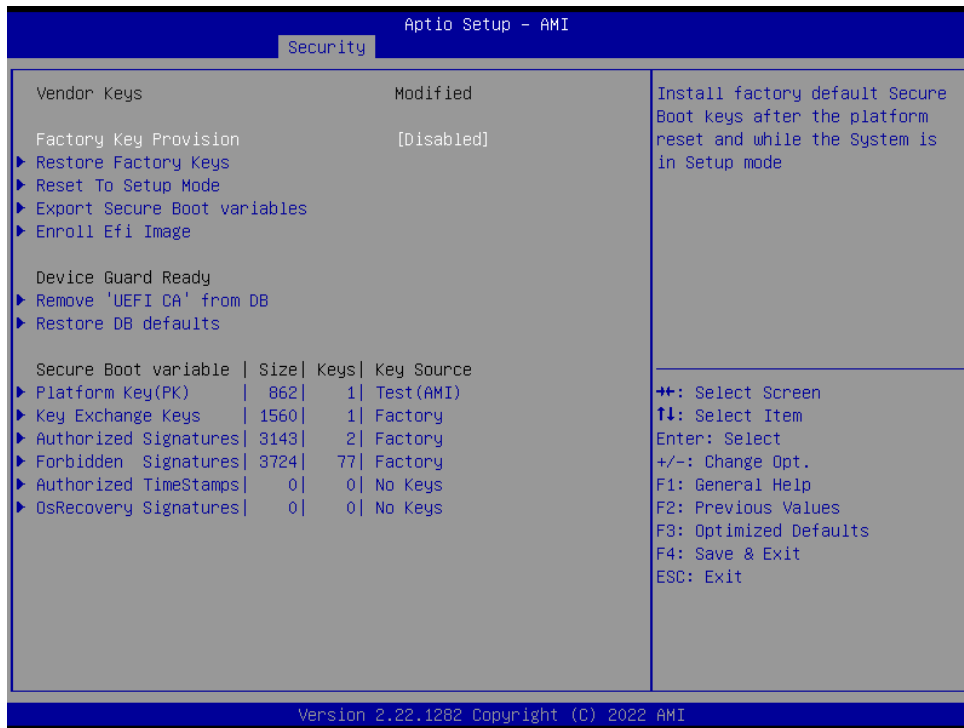

Item	Option	Description
Factory Key Provision	Disabled[Default] Enabled	Install factory default Secure Boot keys after the platform reset and while the System is in Setup mode.

3.6.5 Boot

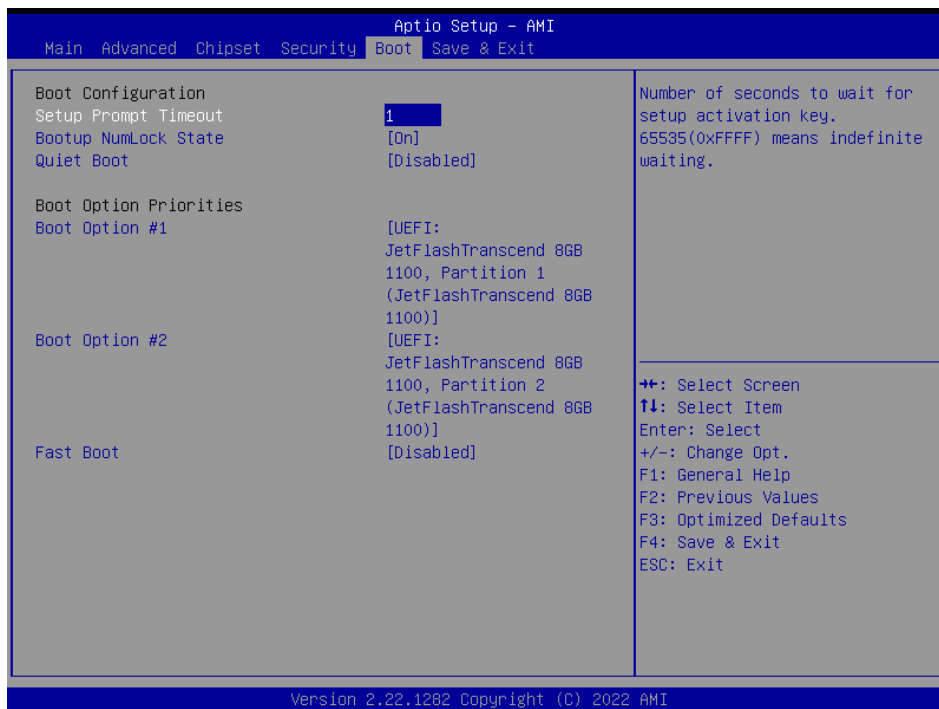

EPC-TGU

Item	Option	Description
Setup Prompt Timeout	1~ 65535	Number of seconds to wait for setup activation key. 65535(0xFFFF) means indefinite waiting.
Bootup NumLock State	On[Default] Off	Select the keyboard NumLock state
Quiet Boot	Disabled[Default] Enabled	Enables or disables Quiet Boot option
Fast Boot	Disabled[Default] Enabled	Enables or disables boot with initialization of a minimal set of devices required to launch active boot option. Has no effect for BBS boot optios.
Boot Option #1/2	Set the system boot order.	

3.6.6 Save and exit

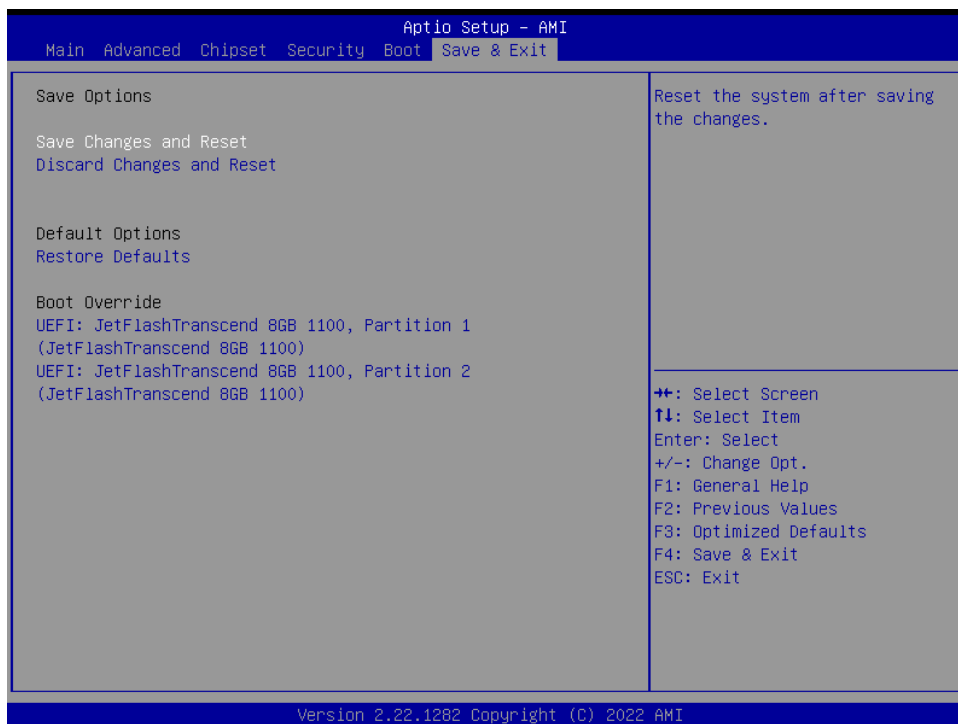

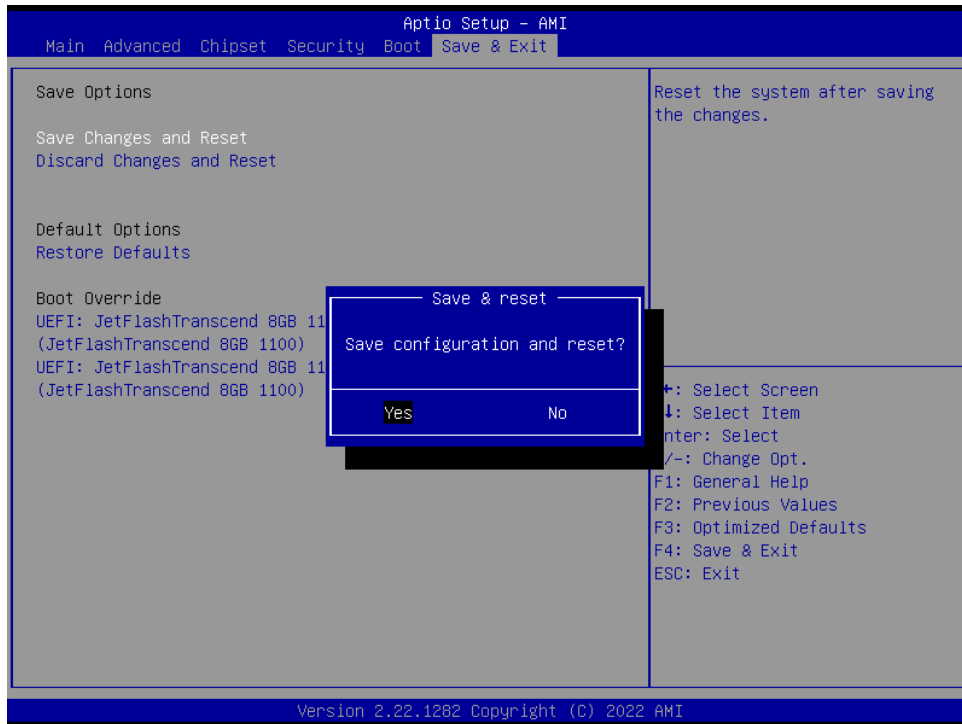

3.6.6.1 *Save Changes and Reset*

Reset the system after saving the changes.

3.6.6.2 *Discard Changes and Reset*

Any changes made to BIOS settings during this session of the BIOS setup program are discarded. The setup program then exits and reboots the controller.

3.6.6.3 *Restore Defaults*

This option restores all BIOS settings to the factory default. This option is useful if the controller exhibits unpredictable behavior due to an incorrect or inappropriate BIOS setting.

3.6.6.4 *Launch EFI Shell from filesystem device*

Attempts to Launch EFI Shell application (Shellx64.efi) from one of the available filesystem devices.

